

# OWNER'S MANUAL

MINI COOPER  
MINI COOPER S





## **CONGRATULATIONS ON YOUR NEW MINI**

This Owner's Manual should be considered a permanent part of this vehicle. It should stay with the vehicle when sold to provide the next owner with important operating, safety and maintenance information.

We wish you an enjoyable driving experience.

# CONTENTS

## NOTES

- About this Owner's Manual 6
- Symbols used 6
- Your individual vehicle 6
- Editorial notice 7
- For your own safety 7
- Symbol on vehicle parts 8
- Service and warranty 8
- Reporting safety defects 9

## OVERVIEW

- Cockpit 12
- Display elements 13
- Display elements with navigation system 14
- Indicator and warning lamps 15
- Multifunction steering wheels 18

## CONTROLS

### Opening and closing:

- Keys 22
- Central locking system 23
- Opening and closing: from outside 23
- Opening and closing: from inside 26
- Tailgate 27
- Electric power windows 28
- Glass sunroof, electric 29
- Roller sun blind 30

### Adjustments:

- Safe seating position 31
- Seat adjustment 32
- Head restraints 33
- Entry to the rear 34
- Safety belts 35
- Seat heating 35
- Steering wheel 36
- Mirrors 36
- Vehicle Memory 37
- Transporting children safely 38

© 2003 Bayerische Motoren Werke  
Aktiengesellschaft  
Munich, Germany  
Reprinting, including excerpts, only with the  
written consent of BMW AG, Munich.  
Order No. 01 41 0 157 644  
US English VIII/03  
Printed in Germany  
Printed on environmentally friendly paper,  
bleached without chlorine, suitable for recycling.

## **Driving:**

- Ignition lock 41
- Starting the engine 41
- Switching off the engine 43
- Parking brake 43
- Manual transmission 44
- Continuously Variable automatic Transmission (CVT) 45
- Parking lamps/Low beams 48
- Turn signal indicator/Headlamp flasher 49
- Instrument lighting 49
- Fog lamps 49
- Interior lamps 50
- Washer/wiper system 50
- Cruise control 52

## **Everything under control:**

- Odometer 54
- Tachometer 54
- Fuel gauge 54
- Coolant temperature gauge 55
- Service interval display 56
- Clock 56
- Onboard computer 57

## **Technology for safety and driving convenience:**

- All Season traction Control (ASC) 59
- Dynamic Stability Control (DSC) 60
- Antilock Brake System (ABS) 61
- Flat Tire Monitor 62
- Park Distance Control (PDC) 64
- Airbags 65

## **Controlling the climate for pleasant driving:**

- Air conditioning system 67
- Automatic climate control 70

## **Interior conveniences:**

- Glove compartment 73
- Ashtray, beverage holders 74
- Cigarette lighter, 12 V power supply 74

## **Loading and transporting cargo:**

- Cargo area 75
- Loading cargo 76
- Roof-mounted luggage rack 78

## **OPERATION, CARE, MAINTENANCE**

### **Special operating instructions:**

- Break-in procedures 82
- General driving notes 83
- Refueling 84
- Fuel specifications 85
- Brake system 86

### **Wheels and tires:**

- Tire inflation pressure 87
- Tire coding 89
- Tire condition 91
- Wheel and tire replacement 92
- Run Flat tires 93
- Snow chains 94

# CONTENTS

## In the engine compartment:

Bonnet [95](#)

Engine compartment: MINI COOPER [96](#)

Engine compartment: MINI COOPER S [97](#)

Washer fluid [98](#)

Engine oil [98](#)

Coolant [100](#)

Brake fluid [101](#)

## Maintenance and care:

MINI Maintenance System [102](#)

Caring for your vehicle [103](#)

Vehicle storage [105](#)

## Laws and regulations:

OBD socket [106](#)

California Proposition 65 warning [107](#)

## OWNER SERVICE PROCEDURES

### Replacement procedures:

Onboard tool kit [110](#)

Windshield wiper blades [110](#)

Lamps and bulbs [111](#)

Repairing a flat tire [116](#)

Changing tires: MINI with space-saver  
spare tire [117](#)

MINI Mobility System [121](#)

Battery [124](#)

Fuses [125](#)

### Giving and receiving assistance:

Jump-starting [126](#)

Towing [128](#)

## TECHNICAL DATA

Engine data [132](#)

Dimensions [133](#)

Weights [134](#)

Capacities [135](#)

## INDEX

Everything from A to Z [138](#)

## NOTES

### About this Owner's Manual

In compiling this Owner's Manual we have made every effort to furnish you with a convenient reference source affording quick access to all the essentials. The fastest way to find detailed information on any specific subject is to turn to the comprehensive index at the back of the manual. If you wish to gain an initial overview of your vehicle, you will find this in the first chapter.

Should you wish to sell your MINI at some time in the future, please remember to hand over this Owner's Manual to the new owner; it is an important part of the vehicle.

If you have any additional questions, your MINI Dealer will be glad to advise you.

### Symbols used



Indicates precautions that must be followed precisely in order to avoid the possibility of personal injury and serious damage to the vehicle.



Contains information that will assist you in gaining the optimum benefit from your vehicle and enable you to care more effectively for your vehicle.



Refers to measures that can be taken to help protect the environment.

◀ Marks the end of a specific item of information.

\* Indicates special equipment, country-specific equipment and optional extras when available.



Vehicle Memory, refer to page 37. Identifies functions that can be specifically adapted for a particular vehicle. These adjustments can be performed either by yourself or by your MINI Dealer.

### Your individual vehicle

The manufacturer of your MINI is the Bayerische Motoren Werke Aktiengesellschaft, BMW AG.

On purchasing your MINI, you have decided in favor of a model with individualized equipment and features. This Owner's Manual describes the entire array of options and equipment that the manufacturer of your MINI makes available with a specific model range.

We hope you will understand that equipment and features are included that you might not have chosen for your vehicle. To assist you in identifying possible variations between your own vehicle and the manual's contents, the passages describing optional accessories and special equipment are marked with an asterisk\*.

If your MINI features equipment that is not described in this Owner's Manual – a car radio, for instance – we have enclosed additional operating instructions. We ask you to read these manuals as well.



## NOTES

### Editorial notice

The manufacturer pursues a policy of continuous, ongoing development that is conceived to ensure that the MINI continues to embody the highest quality and safety standards combined with advanced, state-of-the-art technology. For this reason, the features described in this Owner's Manual could differ from those on your vehicle. Nor can errors and omissions be entirely ruled out.

You are therefore asked to appreciate that no claims can be entertained on the basis of the data, illustrations or descriptions in this Owner's Manual.

### For your own safety

#### Fuels

 Use unleaded gasoline only. Fuels containing up to and including 10% ethanol or other oxygenates with up to 2.8% oxygen by weight, i.e. 15% MTBE or 3% methanol plus an equivalent amount of co-solvent, will not void the applicable warranties with respect to defects in materials or workmanship. Field experience has indicated significant differences in fuel quality, i.e. volatility, composition, additives, etc., among gasolines offered for sale in the United States and Canada. The use of poor-quality fuels may result in driveability, starting and stalling problems, especially under certain environmental conditions such as high ambient temperature and high altitude.

Should you encounter driveability problems which you suspect could be related to the fuel you are using, we recommend that you respond by switching to a recognized high-quality brand.

Failure to comply with these recommendations may result in unscheduled maintenance.

Obey pertinent safety rules when you are handling gasoline. ◀

### Maintenance and repair

 Advanced technology, e.g. the use of modern materials and high-performance electronics, requires specially adapted maintenance and repair methods. Therefore, only have corresponding work on your MINI carried out by a MINI Dealer or a workshop that works according to MINI repair procedures with correspondingly trained personnel. If work is carried out improperly there is a danger of consequential damage and the related safety risks. ◀

## NOTES

### Parts and accessories

 For your own safety, use genuine parts and accessories approved by the manufacturer of the MINI.

When you purchase accessories tested and approved by the manufacturer of the MINI and Original MINI Parts, you simultaneously acquire the assurance that they have been thoroughly tested by the manufacturer of the MINI to ensure optimum performance when installed on your vehicle.

The manufacturer of the MINI warrants these parts to be free from defects in material and workmanship.

The manufacturer of the MINI will not accept any liability for damages resulting from installation of parts and accessories not approved by the manufacturer of the MINI.

The manufacturer of the MINI cannot test every product from other manufacturers to verify if it can be used on a MINI safely and without risk to either the vehicle, its operation, or its occupants.

Original MINI Parts, MINI Accessories and other products approved by the manufacturer of the MINI, together with professional advice on using these items, are available from all MINI Dealers.

Installation and operation of non-MINI

approved accessories such as alarms, radios, amplifiers, radar detectors, wheels, suspension components, brake dust shields, telephones, including operation of any portable cellular phone from within the vehicle without using an externally mounted antenna, or transceiver equipment, e.g. CB, walkie-talkie, ham radio or similar, may cause extensive damage to the vehicle, compromise its safety, interfere with the vehicle's electrical system or affect the validity of the MINI Limited Warranty. See your MINI Dealer for additional information. ◀

 Maintenance, replacement, or repair of the emission control devices and systems must be performed by an authorized MINI Dealership or individual using certified MINI parts. ◀

### Symbol on vehicle parts

 Indicates that you should consult the relevant section of this Owner's Manual for information on a particular part or assembly.

### Service and warranty

This manual is supplemented by a Service and Warranty Information Booklet for US models or a Warranty and Service Guide Booklet for Canadian models.

We recommend that you read this publication thoroughly.

Your MINI is covered by the following warranties:

- ▷ New Vehicle Limited Warranty
- ▷ Rust Perforation Limited Warranty
- ▷ Federal Emissions System Defect Warranty
- ▷ Federal Emissions Performance Warranty
- ▷ California Emission Control System Limited Warranty.

Detailed information about these warranties is listed in the Service and Warranty Information Booklet for US models or in the Warranty and Service Guide Booklet for Canadian models.

# NOTES

## Reporting safety defects

The following only applies to vehicles owned and operated in the US.

If you believe that your vehicle has a defect which could cause a crash or could cause injury or death, you should immediately inform the National Highway Traffic Safety Administration NHTSA in addition to notifying the MINI Division of BMW of North America, LLC, P.O. Box 1227, Westwood, New Jersey 07675-1227, telephone toll-free 1-866-275-6464.

If NHTSA receives similar complaints, it may open an investigation, and if it finds that a safety defect exists in a group of vehicles, it may order a recall and remedy campaign. However, NHTSA cannot become involved in individual problems between you, your dealer, or BMW of North America, LLC.

To contact NHTSA, you may either call the Auto Safety Hotline toll-free at 1-800-424-9393 or 366-0123 in Washington, D.C. area, or write to: NHTSA, U.S. Department of Transportation, Washington, D.C. 20590. You can also obtain other information about motor vehicle safety from the Hotline.



OVERVIEW

OVERVIEW

CONTROLS

CONTROLS

OPERATION, CARE, MAINTENANCE

OPERATION

OWNER SERVICE PROCEDURES

REPAIRS

TECHNICAL DATA

DATA

INDEX

INDEX

## COCKPIT

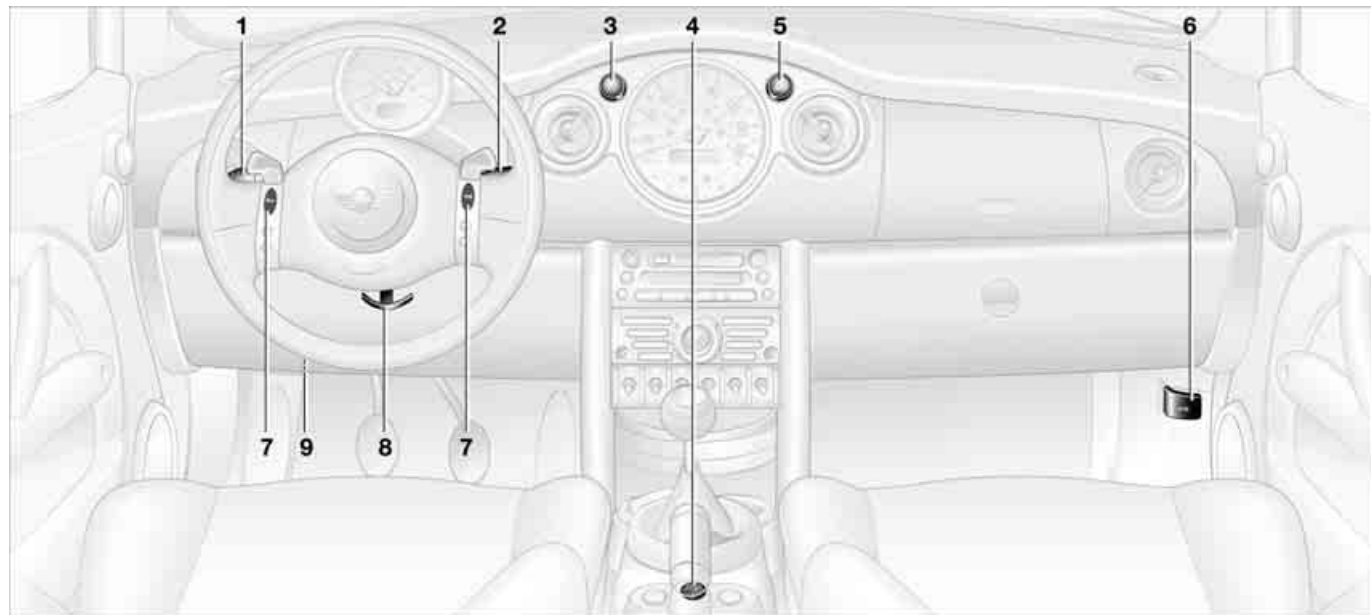

- 1 ▷ Parking lamps/Low beams 48
- ▷ Turn signal indicators 49
- ▷ Standing lamps 48
- ▷ High beams 49
- ▷ Headlamp flasher 49
- ▷ Onboard computer 57

- 2 Washer/wiper system 50
- 3 Instrument lighting 49
- 4 Outside mirror adjustment 36
- 5 Hazard warning flashers

- 6 Bonnet release 95
- 7 Horn 18
- 8 Adjusting steering wheel 36
- 9 OBD interface socket 106

## DISPLAY ELEMENTS

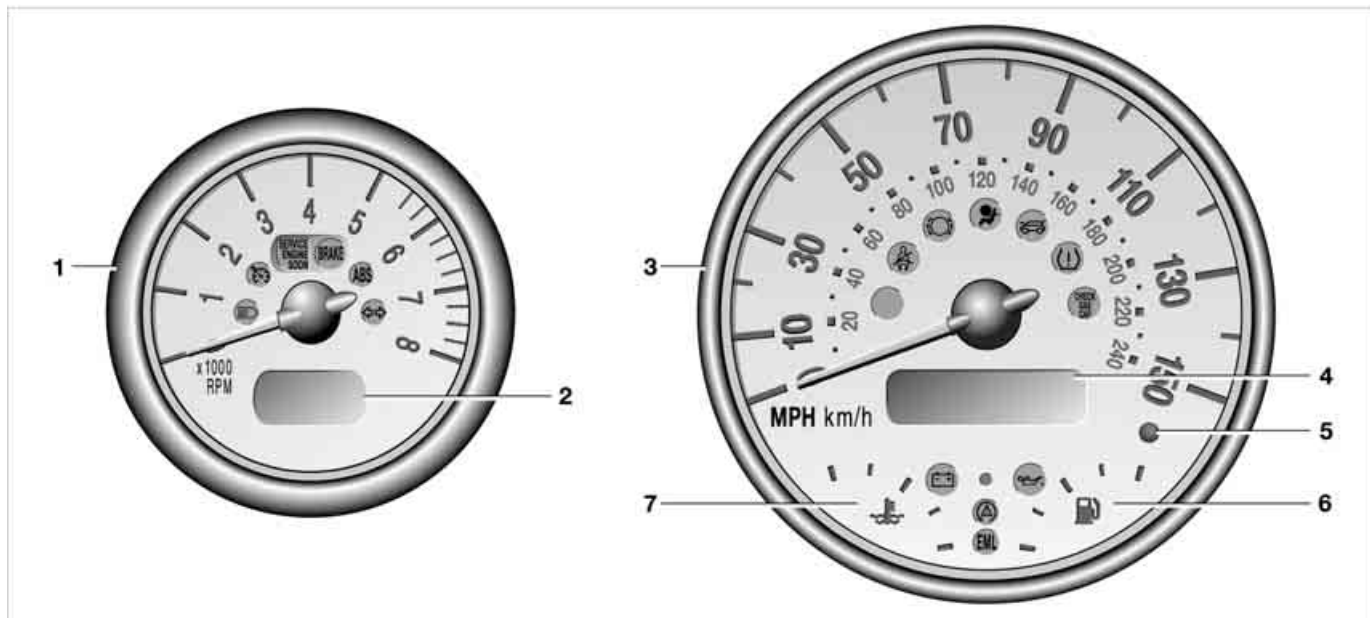

- |  |  |   |
|--|--|---|
| <p>1 Tachometer 54<br/>with indicator and warning lamps,<br/>page 15 ff</p> <p>2 Display for onboard computer 57<br/>If there is no onboard computer:<br/>Display of outside temperature and current vehicle speed</p> <p>3 Speedometer with indicator and warning lamps, page 15 ff</p> | <p>4 Indicator for<br/>▷ Odometer 54<br/>▷ Trip odometer 54<br/>▷ Service interval 56<br/>▷ Program display for Continuously Variable automatic Transmission (CVT) 47</p> <p>5 Trip odometer, reset to zero 54</p> | <p>6 Fuel gauge 54</p> <p>7 Engine coolant temperature gauge 55</p> |
|--|--|---|

## DISPLAY ELEMENTS WITH NAVIGATION SYSTEM\*

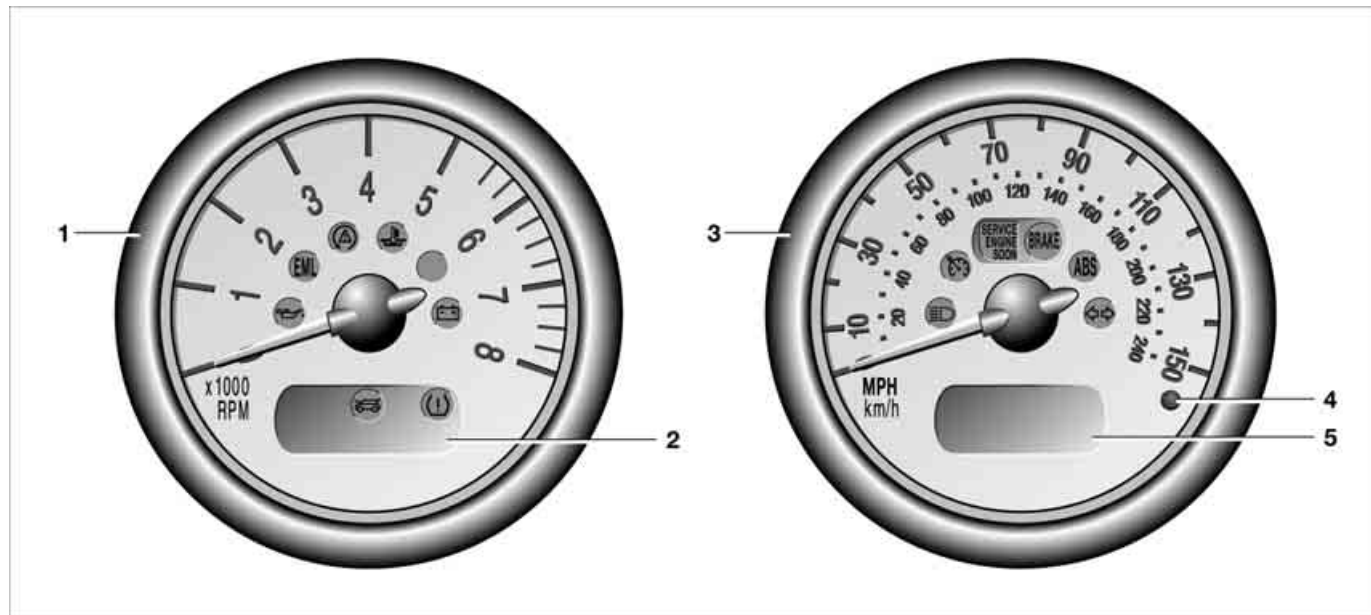

- 1 Tachometer 54  
with indicator and warning lamps,  
page 15 ff
- 2 Additional indicator and warning lamps,  
page 16 ff, display for onboard computer  
in navigation system, refer to separate  
Owner's Manual

- 3 Speedometer with indicator and warning  
lamps, page 15 ff
- 4 Trip odometer, reset to zero 54

- 5 Indicator for
- ▷ Odometer 54
  - ▷ Trip odometer 54
  - ▷ Service interval 56
  - ▷ Program display for Continuously Vari-  
able automatic Transmission  
(CVT) 47



## INDICATOR AND WARNING LAMPS

### Technology that monitors itself

The system runs a check on the indicator and warning lamps marked by ● each time you switch on the ignition. They each light up once for different periods of time.

If a malfunction should occur in one of these systems, the corresponding lamp does not go out after the engine is started or it lights up while the vehicle is moving. You will see below the correct way to react to this.

### Red: stop immediately



**Battery charge current ●**  
The battery is no longer being charged. Indicates a defective alternator drive belt or a problem with the charge circuit. Please contact the nearest MINI Dealer.

If this lamp lights up, the power-assist for steering can be deactivated.



If the drive belt is defective, do not continue driving. The engine could be damaged due to overheating. When the power-assist is deactivated, increased steering effort is required. ◀



**Engine oil pressure ●**  
Stop immediately. Switch off engine. Check the engine oil and fill as needed. Please contact the nearest MINI Dealer.



Do not continue driving; otherwise, the engine could be damaged because of inadequate lubrication. ◀



**Brake warning lamp ●**  
Lights up although parking brake is released: check the brake fluid level. Before driving further, be sure to comply with the information on pages 86 and 101.



**Brake warning lamp for Canadian models.**

With navigation system option:



**Coolant temperature warning lamp in the speedometer ●**  
Lights up while driving:

Engine is too hot. Switch off the engine immediately and allow to cool down, also refer to page 55.

## INDICATOR AND WARNING LAMPS

### Yellow: stop immediately



Flat Tire Monitor ●

Flashes: tire failure.

Reduce speed immediately and stop the vehicle.

With Run Flat tires:

Carefully reduce the driving speed to below 50 mph / 80 km/h and continue to a safe location.

In both cases, avoid hard brake applications and steering maneuvers. Check the tire inflation pressures.

Conduct in the event of a flat tire, refer to pages 93, 116, 117, 121.

General information on the system, refer to page 62.

### Red and yellow: continue driving cautiously



Brake warning light together with yellow indicator lamp for ABS, CBC, EBD and ASC/DSC:



The control system ABS, CBC, EBD and ASC/DSC has failed. Drive cautiously and defensively. Avoid full brake applications.



Please have the system checked by your MINI Dealer as soon as possible.

More information on pages 59, 60.



Brake warning lamp together with the yellow indicator warning lamps ABS, CBC, EBV and ASC/DSC for Canadian models.



### Red: an important reminder



Brake warning lamp with parking brake applied.

More information on the parking brake on page 43.



Brake warning lamp for Canadian models.



Fasten safety belts ●

Lights up for several seconds or, depending on the version, until after the safety belts are fastened. A signal\* also sounds depending on the version.

More information on page 35.



Depending on the level of equipment, the indicator lamp is in the vicinity of the navigation system. ◀



Airbags ●

Please have the system inspected at your MINI Dealer.

More information on page 65.



Depending on the level of equipment, the indicator lamp is in the vicinity of the navigation system. ◀



Bonnet/Tailgate

Lights up when the bonnet and/or tailgate are open.

More information on pages 27, 95.



Brake pads

Have the condition of the brake pads checked.

More information on page 86.



Depending on the level of equipment, the indicator lamp is in the vicinity of the navigation system. ◀

## INDICATOR AND WARNING LAMPS

### Yellow: check as soon as possible



#### Flat Tire Monitor ●

Stays lit: the system is defective. Please have the system inspected at your MINI Dealer.

More information on page 62.



#### Antilock Brake System (ABS) ●

ABS has been deactivated in response to system malfunction.

Conventional braking efficiency is available. Please have the system inspected at your MINI Dealer.

More information on page 61.



ABS indicator lamp for Canadian models.



All Season traction Control (ASC)/Dynamic Stability Control (DSC) ●

Indicator lamp flashes:

System active: drive and braking forces are regulated.

The indicator lamp stays lit: ASC/DSC switched off with button or defective. In the event of a defect: please have the system inspected at your MINI Dealer.

More information on pages 59, 60.



#### Service Engine Soon ●

If the warning lamp comes on either continuously or intermittently, this indicates a malfunction in the emissions-related electronic systems. Although the vehicle remains operational, you should have the systems checked by your MINI Dealer at the earliest possible opportunity.



Service Engine Soon warning lamp for Canadian models.



#### Engine electronics\* ●

Malfunction in the engine electronics. You can continue to drive with reduced engine output or engine speed. Please have the system inspected at your MINI Dealer.



#### Check Gas Cap\* ●

This indicator lamp comes on when the fuel gas cap is loose or missing. Close the gas cap tightly: Refer to page 85.



Depending on the level of equipment, the indicator lamp is in the vicinity of the navigation system. ◀

### Green: for your information



#### Turn signal indicators

Flashes when turn signal indicator is on.

Rapid flashing: the system is defective. More information on page 49.



#### Cruise control

Lights up when the cruise control is activated: operation via the multi-

function steering wheel or multifunction sports steering wheel. More information on page 52.

### Blue: for your information



#### High beams

Comes on when the high beams are on or the headlamp flasher is actuated.

More information on page 49.

## MULTIFUNCTION STEERING WHEELS\*

### Steering wheels with multifunctions

The control buttons integrated within the multifunction steering wheel and the multifunction sports steering wheel have been designed to allow you to operate a number of accessories both quickly and safely, without taking your eyes from the road:

- ▷ Some audio source functions
- ▷ Cruise control.

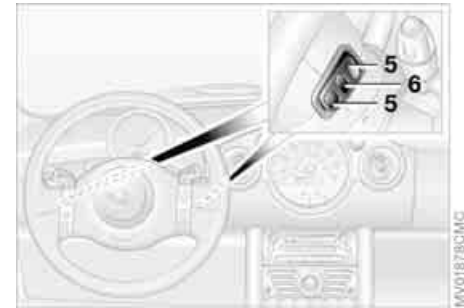
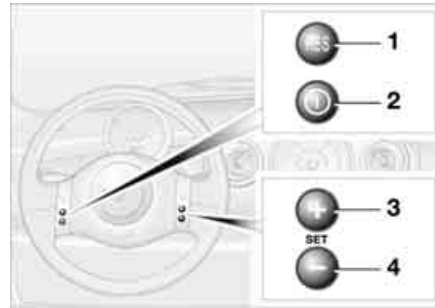

### Steering wheel

- 1 Call up and continue cruise control
- 2 Activate/interrupt/deactivate cruise control
- 3 Store and accelerate cruise control
- 4 Store and decelerate cruise control

Right:

- 5 Volume
- 6 Changing between radio, CD and cassette

Left:

5 Operation of:

▷ Radio

Press briefly: next/previous station stored in memory  
Extended pressure: station scan

▷ CD

Press briefly: jump to next track  
Extended pressure: search within current title

▷ Cassette

Press briefly: jump to next track or stop fast forward  
Extended pressure: fast forward/rewind



If the Wave radio is installed, the above options for cassette player operation are not available. ◀

## MULTIFUNCTION STEERING WHEELS\*

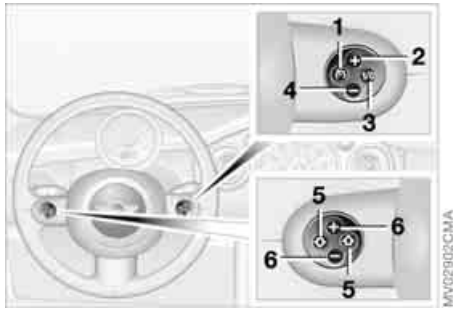

### Sports steering wheel

- 1 Call up and continue cruise control
- 2 Store and accelerate cruise control
- 3 Activate/interrupt/deactivate cruise control
- 4 Store and decelerate cruise control

### 5 Fast forward/rewind

- ▷ Radio  
Press briefly: next/previous station stored in memory  
Extended pressure: station scan
- ▷ CD  
Press briefly: jump to next track  
Extended pressure: search within current title
- ▷ Cassette  
Press briefly: jump to next track or stop fast forward  
Extended pressure: fast forward



If the Wave radio is installed, the above options for cassette player operation are not available. ◀

### 6 Volume

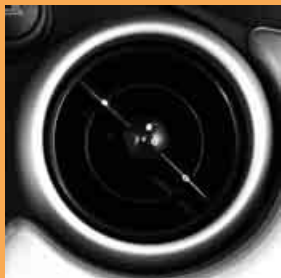

OVERVIEW

OVERVIEW

CONTROLS

CONTROLS

OPERATION, CARE, MAINTENANCE

OPERATION

OWNER SERVICE PROCEDURES

REPAIRS

TECHNICAL DATA

DATA

INDEX

INDEX

## KEYS

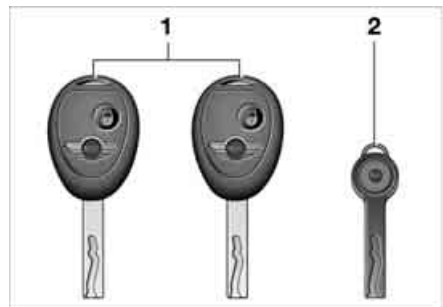

The key set of your MINI consists of three keys.

### 1 Two master keys with remote control

 If the battery is discharged, please consult your MINI Dealer. For changing the battery, refer to the next section. ◀

### 2 Spare key

For keeping in a safe place, e.g. in your wallet. This key is not intended for constant use



## Changing battery

Replace it if it is no longer possible to unlock the vehicle via the remote control.

 Only use a battery of the type specified on the battery, CR 2032, and make absolutely sure that it is fitted in the correct position. ◀



1. Apply a screwdriver at the recess
2. Use the screwdriver to lever out the cover.

 Return used batteries to a recycling point or your MINI Dealer. ◀

## Initializing the master key with remote control



When you activate a master key with remote control – for example a replacement or additional key, or after a battery change – it must be initialized.

This initialization can be performed in two ways:

Press button  or button , refer to page 24, four times in succession

or

if the vehicle is unlocked:

1. Switch the ignition on briefly, position 2, and then off
2. Within 10 seconds, press button  and button , refer to page 24, in succession.

 In the event of a system malfunction, please contact your MINI Dealer. You can also obtain replacement keys and batteries there. ◀



## CENTRAL LOCKING SYSTEM

### The concept

The central locking system is ready for operation whenever the driver's door is closed. The doors, the tailgate and the fuel filler door are unlocked or locked.

The central locking system secures your MINI:

- ▷ When operated from the outside via the remote control as well as via the door lock
- ▷ When operated from the inside via a switch.

If operated from outside, the anti-theft system is activated at the same time. This prevents the doors from being unlocked via safety lock buttons or door handles.

In the event of an accident, the central locking system unlocks automatically. The hazard warning system and interior lamps are also switched on.

## OPENING AND CLOSING: FROM OUTSIDE

### Via remote control

The remote control gives you an exceptionally convenient method for unlocking and locking your vehicle. It also offers additional functions:

- ▷ To open the power windows and the glass sunroof, refer to page 24.

Locking/unlocking the vehicle automatically activates/deactivates the anti-theft system and switches the interior lamps off/on.

If the vehicle has been properly locked using the remote control, the hazard warning system flashes once.

When the vehicle is unlocked, the hazard warning system does not react.

 Children might be able to lock the doors from the inside. Always take the vehicle keys with you so that the vehicle can be opened again from the outside at any time. ◀

### For US owners only

The transmitter and receiver units comply with part 15 of the FCC, Federal Communications Commission, regulations. Operation is governed by the following:

FCC ID: LX8765S  
LX8765E  
LX8CAS

Compliance statement:

This device complies with part 15 of the FCC Rules. Operation is subject to the following two conditions:

- ▷ This device may not cause harmful interference, and
- ▷ this device must accept any interference received, including interference that may cause undesired operation.

 Any unauthorized modifications or changes to these devices could void the user's authority to operate this equipment. ◀

## OPENING AND CLOSING: FROM OUTSIDE

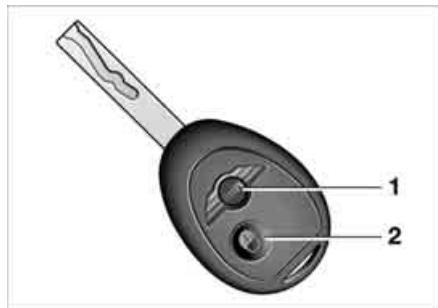



- 1 Unlocking and convenience opening
- 2 Locking and securing

 If the remote control does not react, the battery is discharged.

In the event of a system malfunction, please contact your MINI Dealer. You can also obtain replacement keys and batteries there.

Battery changing, refer to page 22. ◀

### Unlocking

1. Press button  once to unlock the driver's door only.  
The interior lamps are switched on and the hazard warning flashers flash twice\*
2. Press button  a second time to unlock the other door as well as the tailgate and the fuel filler door.

 You can have this function activated/deactivated by your MINI Dealer. ◀

 If none of the vehicle doors are opened within 2 minutes, the central locking system locks the vehicle automatically. The anti-theft system is not activated. To deadlock the vehicle, refer to the next column. ◀

 You can have the vehicle's automatic locking feature activated/deactivated. ◀

### Convenience opening mode

Press and hold button  .  
The power windows and glass sunroof are opened.

 You can have the opening of the windows and glass sunroof with the remote control activated/deactivated. ◀

 Convenience closing is not possible by means of the remote control. ◀

### Locking and securing

Press button  .  
The hazard warning system flashes once.

## OPENING AND CLOSING: FROM OUTSIDE

### Malfunctions

External systems or devices may cause local interference in the functions of the remote control.

In this case, unlock the vehicle via the door lock.

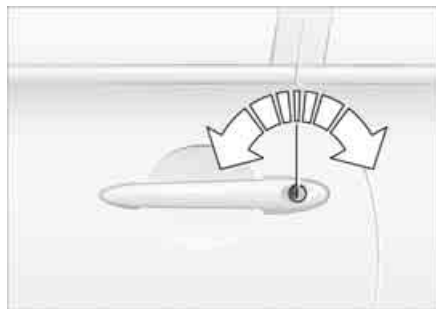

### Via the door lock

1. One turn of the key in the driver's door lock unlocks the driver's door only
2. Turning the key a second time unlocks the other door, the tailgate and the fuel filler door.



You can have this function activated/deactivated by your MINI Dealer. ◀

If the vehicle has been properly locked, the hazard warning system flashes once.  
When the vehicle is unlocked, the hazard warning system flashes twice\*.

### Manual operation

In the event of electrical malfunction:

The driver's door can be locked or unlocked by turning the key in the door lock all the way to the left or right.

### Convenience closing via the door lock

You can also close the power windows and the glass sunroof via the door lock.

With the door closed, hold the key in the locking position.



You can have the closing of the windows and glass sunroof via the door lock activated/deactivated. ◀

## OPENING AND CLOSING: FROM INSIDE

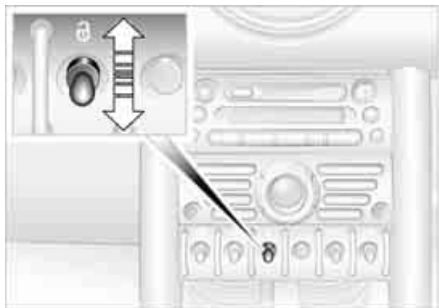

With this switch, you operate the central locking system when the doors are closed. The doors and tailgate are unlocked or locked only. The anti-theft system is not activated.

 If the remote control has been used to unlock only the driver's door, refer to page 24, and you touch the switch when the driver's door is open, the other door, the tailgate, and the fuel filler door are unlocked.

If the driver's door is closed, touching the switch locks it. ◀

### To lock

Briefly press the switch downward

or

push down the safety lock buttons on the doors.

 After you have driven off, the central locking system automatically locks your MINI once a certain speed has been reached. ◀



You can have this function activated/deactivated by your MINI Dealer. ◀



Do not lock the safety lock buttons while driving, since these doors will not unlock automatically in the event of an accident. Children might be able to lock the doors from the inside. Always take the vehicle's keys with you so that you can open the vehicle again from the outside at any time. ◀

### To unlock and open the doors

1. Briefly press the switch upward
2. Pull the door handle above the armrest

or

pull the door handle for each door twice: to unlock first and then open.

# TAILGATE



## To open from the outside

Push the button in the strip handle and open the tailgate.

For information on unlocking via the central locking system, refer to page 26.

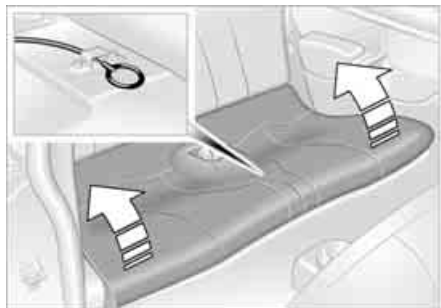

## To unlock manually

In the event of an electrical malfunction, you can also unlock the tailgate manually.

1. Fold the rear seat bench upwards
2. Pull the ring.  
The tailgate is unlocked.



## To close

The handle recesses in the interior trim panel of the tailgate make it easier to pull the lid down.

 To avoid injuries, be sure that the travel path of the tailgate is clear when it is closed, as with all closing procedures.

Operate the vehicle only when the tailgate is closed. Otherwise, exhaust fumes could penetrate the interior of the vehicle. ◀

Should it be absolutely necessary to operate the vehicle with the tailgate open:

1. Close all windows and the glass sunroof
2. Sharply increase the air supply for the air conditioning or automatic climate control, refer to page 67 or 70.

## ELECTRIC POWER WINDOWS

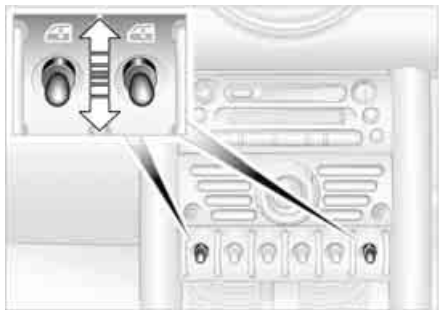

### To open and close windows

From ignition key position 1:

To open:

Press the switch downwards.

The window opens until you release the switch

or

briefly press the switch downwards.

The window opens automatically.

Pressing the switch again stops the operation.

To close:

Press the switch upwards.

The window closes until you release the switch

or

with the engine running:

Briefly press the switch upwards.

The window closes automatically.

Pressing the switch again stops the operation.



The window on the front passenger's side cannot be closed automatically. ◀



Watch during the closing process to be sure that no one is injured. ◀

After the ignition has been switched off:

You can continue using the electric power windows for a limited period as long as no one opens any of the doors.

If a door is opened during operation, the opening/closing process stops immediately.



When leaving the vehicle, always remove the ignition key from the lock and remember to close the doors, e.g. to prevent children from operating the power windows and injuring themselves. ◀

### Convenience operation

For convenience operation using the remote control refer to page 24, for operation via the door lock refer to page 25.

### To initialize power windows



If the battery is disconnected, e.g. for changing batteries or vehicle storage, re-initialize the power windows. Otherwise the windows will not be lowered when the door is opened. ◀

1. Close the doors
2. Close both windows
3. Hold both switches of the power windows up for approx. one second.



In the event of a system malfunction, please contact your MINI Dealer. ◀

## GLASS SUNROOF, ELECTRIC\*

 To prevent injuries, exercise care when closing the glass sunroof and keep it in your field of vision until it is shut. Make sure that the closing path of the sunroof is clear.

When leaving the vehicle, always remove the ignition key from the lock and remember to close the doors, e.g. to prevent children from operating the sunroof and injuring themselves.

Be sure that adequate clearance is maintained for the opening path of the glass sunroof; otherwise damage can occur. ◀

### Convenience operation

For convenience operation using the remote control refer to page 24, for operation via the door lock refer to page 25.

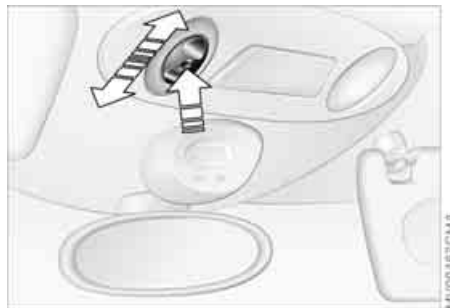

### To raise

From ignition key position 1:

Press the switch

or

push the switch backwards to the resistance point.

### To open and close

From ignition key position 1:

1. Push the switch in the desired direction until you feel resistance, and hold in this position
2. Release the switch when the desired sunroof position has been reached.

 Do not use force to close the glass sunroof in its raised position, as damage to the mechanism could result. ◀

After the ignition has been switched off:

You can continue using the electric power windows for a limited period as long as no one opens any of the doors.

If a door is opened during operation, the opening/closing process stops immediately.

### Automatic opening and closing

From ignition key position 2:

To open:

Push the switch back past the point of resistance:

The sunroof opens completely.

To close:

1. Press the switch past the pressure point:  
The sunroof closes to the raised position
2. Press the switch again and keep it depressed:  
The sunroof closes completely.

Touching the switch briefly during opening and closing stops the movement immediately.

## GLASS SUNROOF, ELECTRIC\*

### Pinch protection

If, while closing, the glass sunroof encounters resistance within roughly the last 8 in / 20 cm, the closing procedure is interrupted and the roof reopens.

 Despite the pinch protection, be extremely careful that the travel path of the sunroof is not obstructed whenever it is closed. Otherwise, it is not guaranteed that the closing procedure will be interrupted, for instance if the obstructions offer very little resistance.

You can disable the pinch protection by pressing the switch past the pressure point and holding it. ◀

 When closing the sunroof from the raised position, ensure that the travel path of the sunroof is not obstructed since the pinch protection is not active in this position. ◀

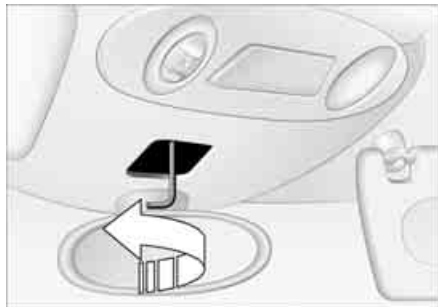

### Manual opening and closing

In the event of an electrical malfunction, you can also open and close the glass sunroof manually:

1. Push the clock towards the interior and remove
2. Use an Allen key to turn the glass sunroof in the direction required.

## ROLLER SUN BLIND\*



### 1 Opening

1. Press the button in the handle, arrow 1  
The cap is unlocked
2. Guide the roller sun blind towards the back.

### 2 Closing

1. Use the handle to pull the roller sun blind forwards
2. Engage the handle in the device, arrow 2.



## SAFE SEATING POSITION

The ideal seating position can make a vital contribution to relaxed, relatively fatigue-free driving. Together with the safety belts and airbags, the seating position also plays an important role in providing occupants with maximum levels of passive safety in an accident. To ensure that the safety systems operate with optimal efficiency, we strongly urge you to observe the instructions contained in the following section.

For additional information about transporting children safely, refer to page 38.

### Sitting safely with airbags

 Always maintain an adequate distance between yourself and all of the airbags. Always hold the steering wheel by the rim with the hands at the 9 and 3 o'clock positions to keep any chance of injury to hands or arms to an absolute minimum, should the airbag be deployed.

No one and nothing is to come between the airbags and the seat occupant. Do not use the front passenger airbag cover as a storage surface for objects of any kind. Ensure that the front passenger is correctly seated, i.e. that no feet or legs are propped against the dashboard. Otherwise, leg injury could result if the front passenger airbag suddenly deployed. Never let an occupant's

head rest near or on a side airbag because the inflating airbag could cause a serious or fatal injury. ◀

Even if all these instructions are followed, it cannot entirely be ruled out that in some circumstances injury may result from contact with the airbags. In sensitive individuals, the ignition and inflation noise may induce a mild hearing loss that is usually temporary.

For airbag locations and additional information on airbags, refer to page 65.

### Safe seating position with safety belt

Fasten your safety belt before each drive. Airbags are an additional safety device and work in conjunction with the safety belts, but do not replace them.

Your vehicle is equipped with four seats, each of which is provided with a safety belt.

 At all times, occupants should sit upright and be properly restrained – infants and small children in appropriate child-restraint systems; larger children and adults using the safety belts. Expectant mothers should always wear their safety belts, taking care to position the lap belt against the lower hips, where it

will not exert pressure against the abdominal area.

Never allow more than one person to wear a single safety belt. Never allow infants or small children to ride in a passenger's lap. Do not route the belt across your neck, or run it across sharp edges. Be sure that the belt does not become caught or jammed. Avoid twisting the belt while routing it firmly across the hips and shoulder; wear it as snugly against your body as possible and do not allow it to rest against sharp or fragile objects. Otherwise, the belt could slide over your hips in the event of a frontal impact and cause abdominal injury. Avoid wearing bulky clothing and pull on the lap belt periodically to retension it over your shoulder. Otherwise, the safety belt's restraint effectiveness could be reduced. ◀

For information on using the safety belts, refer to page 35.

## SEAT ADJUSTMENT

### Important adjustment information

 Never try to adjust your seat while operating the vehicle. The seat could respond with an unexpected movement, and the ensuing loss of vehicle control could lead to an accident.

While driving, do not recline the backrest too far toward the rear. This especially applies to the front passenger side. If you do so, there is a risk that you will slide under the safety belt in an accident, thus reducing the protection provided by the safety belt. ◀

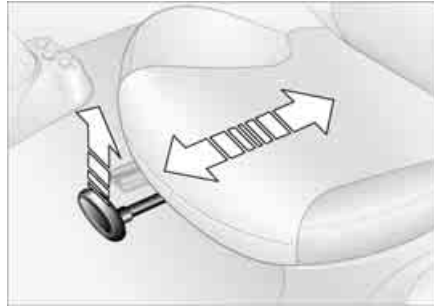

### Longitudinal adjustment

1. Lift the handle
2. Push the seat into the desired position
3. After releasing the handle, apply pressure to the seat to ensure that the latch engages securely.

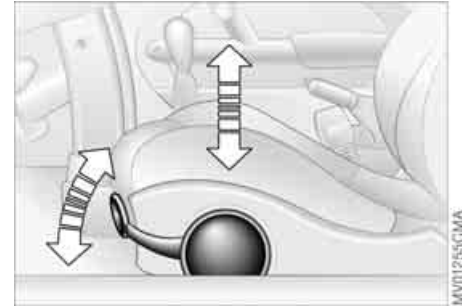

### Height adjustment

1. To raise:  
Pull the handle up repeatedly, continuing until the seat reaches the desired height
2. To lower:  
Push the handle repeatedly, continuing until the seat reaches the desired height.

## SEAT ADJUSTMENT



### Lumbar support\*

You can adjust the contour of the backrest for additional support in the curvature of your spine's lumbar region. The upper hips and spinal column receive supplementary support to help you maintain a relaxed, upright posture.

Turn the wheel.

The contour is strengthened or weakened.

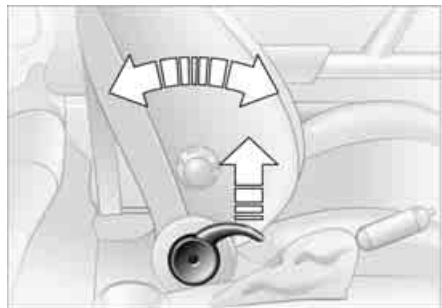

### Backrest tilt

1. Pull up the lever at the inside of the seat
2. Apply weight to or remove weight from the backrest as required
3. Release the lever so that the backrest locks into place.

## HEAD RESTRAINTS

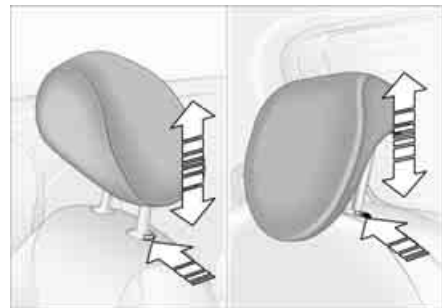

### Adjusting

To raise: pull the head restraint upward.

To lower: press the button and push the head restraint downward.

 You can reduce the risk of spinal injury and whiplash by adjusting the head restraint to a height at which it is centered roughly at ear level. ◀

## HEAD RESTRAINTS

### Removal

1. Pull up the head restraint, continuing until it is at maximum extension
2. Press the button and remove the head restraint at the same time.

### Installation

1. Press the button and at the same time insert the head restraint in the reception points
2. Adjust the head restraint.

 To avoid possible violation of traffic laws, never retract the head restraints unless the rear seats are empty. Always ensure that the head restraints are raised before transporting passengers in the rear seat. ◀

## ENTRY TO THE REAR

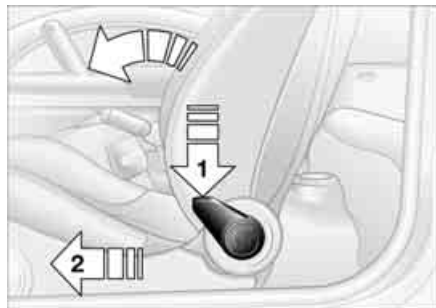

### Easy entry

The Easy entry function includes a memory for the longitudinal seat and the backrest positions.

1. Push down the lever at the outside of the seat, arrow 1.  
The backrest folds forward automatically
2. Push the seat forward, arrow 2.

### Original position

 Slide the seat back to its home position before folding back the backrest, otherwise the seat is latched in at its current position. In this case, adjust the longitudinal position manually, refer to page 32. ◀

1. Push the seat back into its home position
2. Fold the backrest back to the home position to lock the seat.

 When returning the seat to the rear position, ensure that no one is injured and that no objects are damaged. Engage and lock both seats and backrests into position prior to driving; otherwise unexpected movement could increase the risk of accident. ◀

## SAFETY BELTS

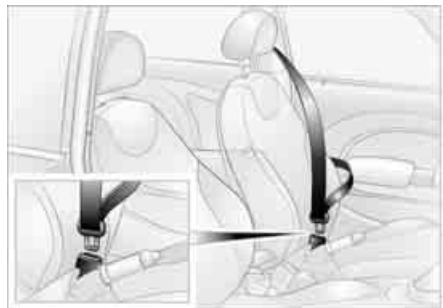

### To close

Make sure you hear the lock engage in the belt buckle.



Fasten safety belts: the warning lamp lights up until after the safety belt is fastened. An acoustic signal sounds for several seconds.

### To release

1. Press the red button in the belt buckle
2. Hold the belt
3. Guide the belt back into its reel.

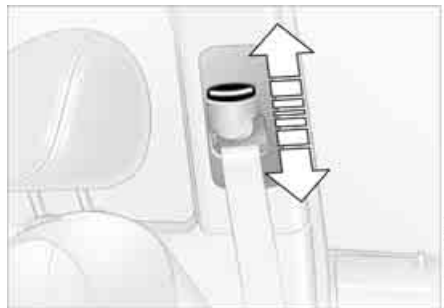

### Safety belt height adjustment

Use the height adjustment mechanism to adapt the safety belt to the ideal position for your own body:

Press the button and at the same time push the entire unit upwards or downwards.

Also observe the instructions on adjusting the seats on page 31.

### Damaged safety belts

 If the safety belts are damaged or stretched in an accident: have the safety belt system replaced by your MINI Dealer and the belt anchors checked, otherwise the safety function can no longer be guaranteed. If a child-restraint system was in the vehicle during an accident, consult the manufacturer's instructions regarding replacement. ◀

## SEAT HEATING\*



The seat cushion and backrest can be heated with the ignition key in position 2.

Select the temperature setting:

Press each button briefly.

Direct deactivation from the second temperature setting:

Press the button for a longer period.

## STEERING WHEEL

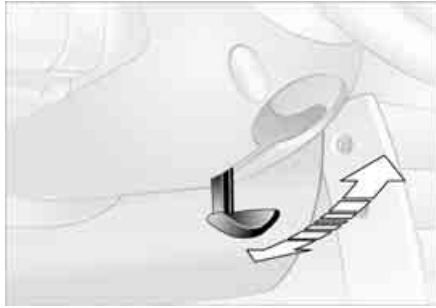

**⚠** Do not adjust the steering wheel while the vehicle is moving; otherwise unexpected movement could increase the risk of accident. ◀

### Adjusting

1. Push the locking lever downward
2. Adjust the desired steering wheel position
3. Pull the lever back in.

## MIRRORS



### Outside mirror adjustment

- 1 Switch for choosing between the left and right mirror
- 2 Switch for 4-way adjustment

### Manual adjustment

The mirrors can also be adjusted manually:  
Press the edge of the lens.

### Electric heating\*

Both mirrors are heated automatically when the ignition key is in position 2.

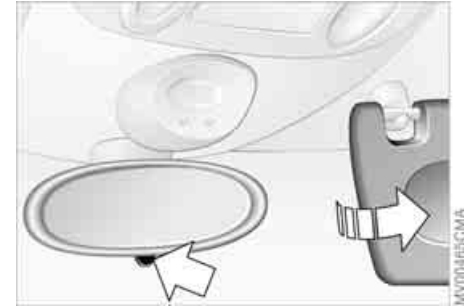

### Interior rearview mirror

To reduce glare from vehicles behind you when you are driving at night:  
Tilt the lever forward.

### Illuminated vanity mirror

From ignition key position 1:  

1. Fold down the sun visor
2. Fold the cover panel upwards.

### Sun visors

Can be swung sideways.

## MIRRORS

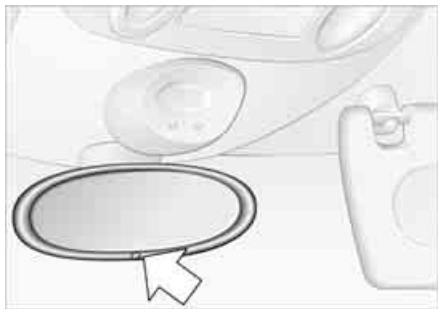

### Interior mirror, automatic dimming\*

This mirror dims automatically as required. The mirror becomes clear again when you engage reverse gear or select position R on the selector lever.

Keep the photocells free and clean to ensure that the mirror functions perfectly. There is one photocell in the mirror frame; the other is on the back of the mirror.

 Do not cover the area between the inside rearview mirror and the windshield, and do not place stickers or toll tags on the windshield in front of the mirror. ◀

## VEHICLE MEMORY

### How the system functions

No doubt you have often reflected on how great it would be if you could configure your vehicle's various adjustment settings to meet your own personal requirements. In developing this vehicle, the manufacturer of the MINI has incorporated a number of options that you or your MINI Dealer can program to suit your individual preferences.

### What the system can do

Your MINI Dealer can provide you with details on the capabilities of the Vehicle Memory system.

Examples for Vehicle Memory:

- ▷ Automatic locking if none of the vehicle doors are opened, refer to page 24
- ▷ Automatic locking after starting to drive, refer to page 26
- ▷ Selective central locking system, refer to pages 24, 25
- ▷ Convenience operation, refer to pages 24, 25
- ▷ 'Follow-me-home' lamps, refer to page 48
- ▷ Daytime driving lamps, refer to page 49
- ▷ Speed-dependent windshield wipers, refer to page 51

- ▷ Setting units for outside temperature and fuel consumption display, refer to page 57
- ▷ Setting units for display of temperatures specified for automatic climate control system, refer to page 71
- ▷ Volume control PDC, refer to page 64
- ▷ Acoustic alarm for starting PDC activation, refer to page 64.



This symbol alerts you to Vehicle Memory functions in the Owner's Manual. ◀

 After memory functions have been reconfigured, your vehicle may operate slightly differently from the descriptions used in this Owner's Manual. If you decide to sell your MINI one day, please remember to have the memory functions reset to their default configuration. ◀

## TRANSPORTING CHILDREN SAFELY

### The proper place for children

Children should always sit in the rear:

Accident research shows that the safest place for children in a vehicle is in the rear seat.

Older children should be tightly secured with a safety belt, after they have outgrown a booster seat that is appropriate for their age, height and weight.

 A child sitting in the rear seat and not properly restrained may place his or her head on or near the airbag, if so equipped. For example, a child – even though belted – may fall asleep with his or her head against the side airbag. It may be difficult for a driver to ensure that children in the rear seat will remain properly positioned at all times and do not place their heads on or near the side airbag. Therefore, we recommend that the rear side airbags, if provided, be deactivated if you plan to transport children in the rear seat. ◀

### Child-restraint system in the rear

 Children under 13 years of age and children less than 5 ft / 150 cm tall should always ride in the rear and the restraint systems should be secured with the vehicle's safety belts. ◀

Younger children should be secured in an appropriate forward-facing child-restraint system that has first been properly restrained. We strongly urge you to carefully read and comply with the instructions for installation and use provided by the child-restraint's manufacturer whenever you use such a device.

All rear seating positions in your vehicle meet the recommendations of SAE J1819, an industry-recommended practice for securing child-restraint systems in motor vehicles.

### Exception for the front passenger seat

 Never install a rearward-facing child-restraint system in the front passenger seat of this vehicle if the passenger's airbag is not deactivated. If you do so, the child could be severely injured or killed when the airbag is triggered. Your vehicle is equipped with an airbag supplemental restraint system for the front passenger. Because the backrest on any rearward-facing child-restraint system – of the kind designed for infants under 1 year and 20 lbs / 9 kg – would be within the airbag's deployment range, you should never mount such a system in the front passenger seat, since the impact of the airbag against the child restraint's backrest could lead to serious or fatal injuries. ◀



## TRANSPORTING CHILDREN SAFELY

### Installing child-restraint systems

Before installing any child-restraint system or child seat, read the following:

 Always follow the manufacturer's instructions concerning installation and use; otherwise the system's protective function could be impaired. After an accident, have all parts of the affected safety belt system inspected and/or replaced by your MINI Dealer. ◀

Commercially available child-restraint systems are designed to be secured with a lap belt or with the lap belt portion of a combination lap/shoulder belt. Improperly or inadequately installed restraint systems can increase the risk of injury to children. Always read and follow the instructions that come with the system.



### Child seat security

All of the rear belt retractors and the front passenger's safety belt can be locked for mounting and securing child-restraint systems.

Information regarding this is located near the buckle latch of each safety belt.

### To lock the belt

Pull the entire length of the belt from the belt retractor. Allow the reel to retract the belt somewhat and engage the buckle, then tighten the belt against the child-restraint system.

The retraction mechanism is now locked.

### To unlock the belt

Release the buckle, remove the child-restraint system and allow the belt retractor to reel the belt completely in.

## TRANSPORTING CHILDREN SAFELY

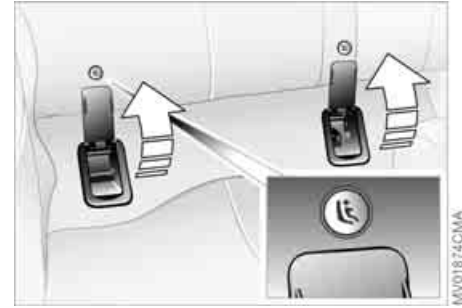
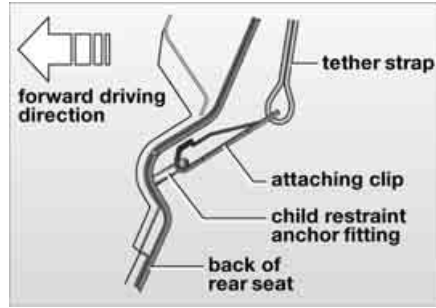

### Child-restraint system with tether strap

If you use a child-restraint system with a tether strap:

Depending on the location selected for seating in the rear passenger area, attach the tether strap to the corresponding anchorage point to secure the child-restraint system.

Both seating positions are fitted with a head restraint.

Lift the head restraint and pass the tether strap between the head restraint and the seat back. It is recommended to readjust the head restraint into the lowest possible position.

Adjust the tether strap according to the child-restraint manufacturer's instructions.

### LATCH child-restraint mounting system

Open the cover.

The illustration is an example showing the mounts for the LATCH, Lower Anchors and Tethers for Children, child-restraint mounting system at the right rear.

The system is also available at the left rear position.

Canadian models only:

The LATCH anchorage points are identified by buttons, see illustration.



Always follow all manufacturer's instructions and observe all safety precautions when installing the LATCH child-restraint system. ◀

## IGNITION LOCK

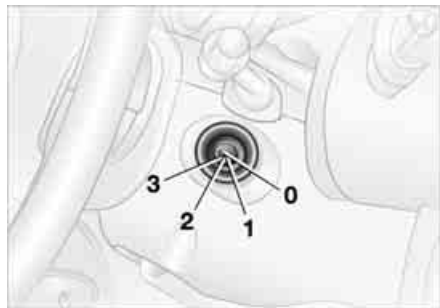

### 0 Steering locked

The key can be inserted or removed in this position only.

To lock the steering:

1. Remove the key
2. Turn the steering wheel slightly to the left or right until the lock engages.

A sound alarm goes off if the key remains in the ignition after opening the driver's door.

Vehicles with Continuously Variable automatic Transmission (CVT):

Do not move the selector lever from position P until the engine is running. The ignition key cannot be turned to position 0 and removed until the selector lever is in position P, interlock.

### 1 Steering unlocked

Individual electrical accessories are ready for operation.

You will find that it is often easier to turn the ignition key from position 0 to position 1 when you move the steering wheel slightly to help disengage the lock.

### 2 Ignition switched on

All electrical accessories are ready for operation.

### 3 Starting the engine

 Vehicles with manual transmission: Step on the clutch when starting the vehicle. A lockout prevents the engine from starting if the clutch is not depressed. ◀

## STARTING THE ENGINE

 Do not let the engine warm up with the vehicle at a standstill. Move off immediately at a moderate engine speed. ◀

 Do not allow the engine to run in enclosed spaces. Breathing the noxious exhaust gases can lead to unconsciousness and death. The exhaust gases contain carbon monoxide, an odorless and colorless, but highly toxic gas. Do not leave the vehicle unattended with the engine running. This is a safety hazard. When driving, standing at idle, and parking the vehicle, take care to avoid contact between the hot exhaust system and flammable materials, e.g. hay, grass, leaves, etc. Such contact could lead to a fire resulting in serious personal injury and property damage. ◀

## STARTING THE ENGINE

### Starting

When starting the engine, do not press the accelerator pedal.

 Do not actuate the starter for too short a time. Do not turn it for more than approx. 20 seconds. Release the ignition key immediately when the engine starts.

Extended starting attempts, characterized by excessively frequent or long periods with the starter engaged, can lead to damage in the catalytic converter. ◀

If the engine does not start on the first attempt, for instance if the engine is very hot or cold:

When starting the engine, press the gas pedal down halfway.

When first starting the engine at very low temperatures, from +5 °F / -15 °C:

When starting the engine, press the gas pedal down halfway. For the initial start attempt, allow the starter to remain engaged somewhat longer, approx. 10 seconds.

### Manual transmission

1. Engage the parking brake
2. Put the manual gearshift lever in neutral
3. Press the clutch pedal
4. Start the engine.



Move the gearshift lever to neutral position and engage the parking brake before leaving your vehicle with the engine running.

Do not leave the vehicle unattended with the engine running. This is a safety hazard. ◀

### Continuously Variable automatic Transmission (CVT)

1. Press the footbrake
2. Put the selector lever in position P or N
3. Start the engine.



Move the selector lever to position P and engage the parking brake before leaving your vehicle with the engine running.

Do not leave the vehicle unattended with the engine running. This is a safety hazard. ◀

## SWITCHING OFF THE ENGINE    PARKING BRAKE

 You should never remove the ignition key when the vehicle is in motion, as the steering lock could engage.

When you leave the vehicle, always remove the ignition key and engage the steering lock.

When you park on downward slopes, engage the parking brake. ◀

### Manual transmission

Turn the ignition key to position 1 or 0.

### Continuously Variable automatic Transmission (CVT)

Engage selector lever position P, turn the ignition key to position 1 or 0.

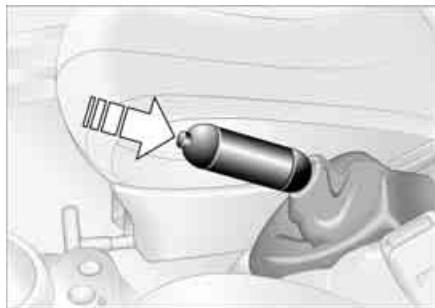

The parking brake is designed primarily to prevent the vehicle from rolling when it is parked. It operates against the rear wheels.

### To engage

Lever automatically locks in position.

The indicator lamp in the instrument cluster lights up from ignition key position 2, refer to page 16.

### To release

1. Pull up slightly
2. Press the button
3. Push the lever downwards.

 If, in exceptional circumstances, it should be necessary to engage the parking brake while the vehicle is in motion, do not pull the lever with excessive pressure. Keep your thumb pressed against the release button while carefully pulling the lever up to apply moderate pressure. Excessive pressure can lead to overbraking and loss of traction, i.e. fishtailing, at the rear axle. The brake lamps do not come on when the parking brake is engaged.

Vehicles with manual transmission:

Always engage the parking brake when parking on hills and inclined surfaces, as first gear or reverse may not provide adequate resistance to rolling.

Vehicles with CVT:

Place the selector lever in P. ◀

 To avoid corrosion and one-sided braking, apply the parking brake lightly from time to time when coasting to a standstill, for instance at a traffic light, provided that it is safe to do so. ◀

# MANUAL TRANSMISSION

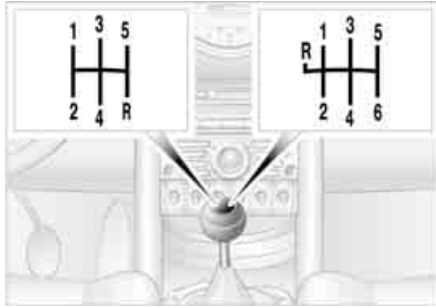

## 6-speed transmission\*

 When changing gear in the 5th/6th gear plane, press the gearshift lever to the right to prevent inadvertently shifting to a gear of the 3rd/4th gear plane. ◀

## Reverse gear

Before selecting reverse gear, ensure the vehicle is stationary; then, fully depress the clutch pedal and pause briefly before moving the gearshift lever into position.

5-speed transmission:

Press the gearshift lever to the right and to the back.

6-speed transmission:

Press the gearshift lever towards the left. Thereby overcome the slight resistance and press forward.

As you do this, the backup lamps will turn on automatically when the ignition key is in position 2.

 Do not hold the vehicle in place on slopes by slipping or 'riding' the clutch. Use the parking brake instead. Riding the clutch causes the clutch assembly to wear out sooner. ◀

## CONTINUOUSLY VARIABLE AUTOMATIC TRANSMISSION (CVT)\*

You can drive with a continuously variable shifting CVT. In addition, you can also shift manually.

When in manual selection mode, you have the option of changing gears by using either the selector lever or the shift paddles on the steering wheel.

Under normal operating conditions, fuel consumption is lowest when driving in position D.

### Selector lever positions

P R N D M/S + -



### Range selection

Inadvertent engaging of certain selector lever positions is prevented by a lock.

Press the button on the front side of the selector lever knob. The lock is released.

▶ While the vehicle is stationary, and before shifting out of P or N, press the brake pedal in order to disengage the selector lever lock mechanism, shiftlock. If the engine speed is too high when the vehicle is at a standstill, the selector lever is also blocked to protect the transmission. Hold the brake pedal down until starting off. Otherwise the vehicle will 'creep' when a drive position is engaged. ◀

⚠ To prevent the vehicle from starting off on its own, always move the selector lever to position P and engage the parking brake before getting out of your vehicle with the engine running. Do not leave the vehicle unattended with the engine running. This is a safety hazard. ◀

▶ If the selector lever is not placed in position P when the vehicle is parked, the position display of the selector lever stays on. This can lead to battery discharge. ◀

# CONTINUOUSLY VARIABLE AUTOMATIC TRANSMISSION (CVT)\*

## P Park

Select P only when the vehicle is completely stopped. The transmission locks to prevent the rear wheels from turning.

## R Reverse

Select P only when the vehicle is completely stopped.

## N Neutral: idle

Select N only if your journey is interrupted for a long period.

## D Drive: CVT driving position

This position is designed for driving under all normal operating conditions.

## Kickdown

In 'kickdown' mode, you achieve maximum acceleration and maximum speed in position D.

Press the accelerator pedal past the increased resistance point at the full-throttle position.

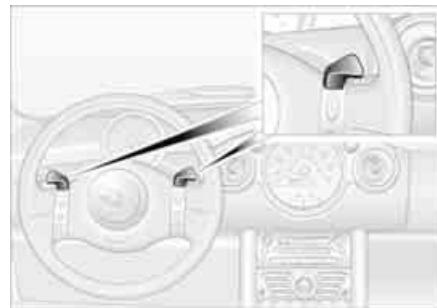

## M/S + – Manual mode and Sport program

Switch from D into M/S + –:

Activates the Sport program and displays SD in the gear indicator in the speedometer.

Press selector lever once:

Shifts from the Sport program to the manual mode.

## Shifting with the selector lever

- ▷ Press selector lever briefly towards +:  
Transmission shifts upwards
- ▷ Press selector lever briefly towards –:  
Transmission shifts back.

1 to 6 appear in the gear indicator.

## Shifting on the steering wheel\*

The shift paddles allow the gears to be changed rapidly and, above all, safely, since both hands can remain on the steering wheel.

Use one of the two shift paddles to shift upwards or downwards:

- ▷ Pull shift paddle toward body:  
Transmission shifts upwards
- ▷ Push shift paddle away from body:  
Transmission shifts back.

1 to 6 appear in the gear indicator.

The transmission will only execute upshifts or downshifts that will result in a plausible combination of vehicle speed and engine rpm, e.g. downshifts that would result in excessive engine speed are not executed.



## CONTINUOUSLY VARIABLE AUTOMATIC TRANSMISSION (CVT)\*

 In order to accelerate rapidly in the M/S + – Manual mode and in the Sport program, e.g. when passing, shift downwards manually or by kickdown. ◀

Whenever you want to return to automatic shifting, just move the selector lever toward the left to position D.

Switching from M/S + – Manual mode into the selector lever positions P, R and N is only possible via D.



### Available displays

P R N D SD 1 2 3 4 5 6 EP

### Electronic transmission control module

If there is a malfunction in the transmission system, EP appears in the display.

All selector lever positions can still be selected. In positions for driving forward: the vehicle can now only be driven with a limited gear selection.

 Avoid high engine loads. Please proceed to the nearest MINI Dealer. ◀

 Do not work in the engine compartment when a drive gear – forward or reverse – is engaged. If you do this, the vehicle could move. ◀

 Jump-starting and towing, refer to pages [126](#), [128](#). ◀

## PARKING LAMPS/LOW BEAMS

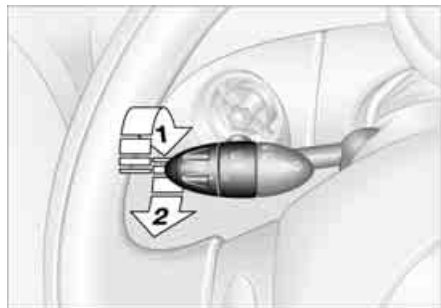

### Switching on the parking lamps

Turn to the first position. The front, rear and side vehicle lighting is switched on. Parking light on one side, refer to following column.

### Switching on the low beams

Turn to the second position. With the low beams on and with the ignition switched off, only the parking lamps will remain on.

### 'Follow me home' lamps

If you activate the headlamp flasher after having switched off the engine and the lights, the low beams will stay lit for a pre-set period of time.



You can have this function set by your MINI Dealer. ◀

### Standing lamps, left or right

For parking, you can activate lights on one side of the vehicle. Observe local laws.

1. Turn the ignition key to position 0 or remove the key
2. Switch on the low beams
3. Move the lever to the adequate turn signal indicator position.

### 'Lights on' warning

If the lights have not been switched off and the ignition key is in position 0, an acoustic signal sounds for a few seconds when you open the driver's door to remind you that the lights have not been switched off.

### Daytime driving lamps\*

If you desire, the light switch can be left in position 2. When the ignition is switched off, the car's exterior lights go out.



The automatic headlamp range control for xenon lamps only operates with the light switch in position 1 or 2. ◀



You can have the daytime driving lamp function activated/deactivated by your MINI Dealer. ◀

## SIGNAL/HEADLAMP FLASHER

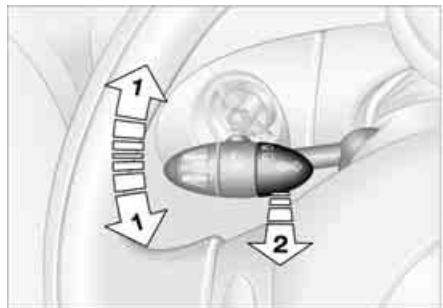

- 1 Turn signal indicator:  
Green indicator lamps and periodic clicking sound from the relay
- 2 High beams/Headlamp flasher:  
Blue indicator lamp

### To signal briefly

Press the lever up to but not beyond the point of resistance.

 If the blinking of the indicator lamp and the clicking from the relay are both faster than normal: one of the turn signal indicators has failed. ◀

## INSTRUMENT LIGHTING



To control the instrument lighting, press the button.

### To increase the illumination intensity

Keep the button pressed until the desired brightness is reached.

### To decrease the illumination intensity

Press the button briefly.  
With each brief pressing of the button, the illumination intensity is reduced in steps.

## FOG LAMPS

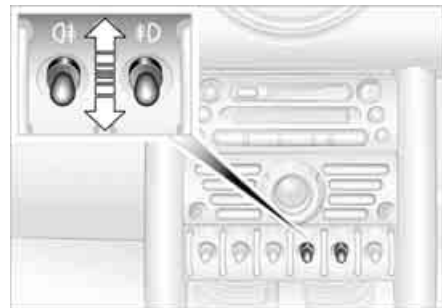

When the parking lamps/low beams are switched on:  
Briefly press the switch upwards or downwards.

Briefly press once again to switch off.

### Fog lamps\*



Fog lamps switched on:  
Green light-emitting diode in the switch lights up.

### Rear fog lamp\*



Rear fog lamp switched on:  
Yellow light-emitting diode in the switch lights up.

Observe all legal regulations concerning the use of fog lamps.

## INTERIOR LAMPS

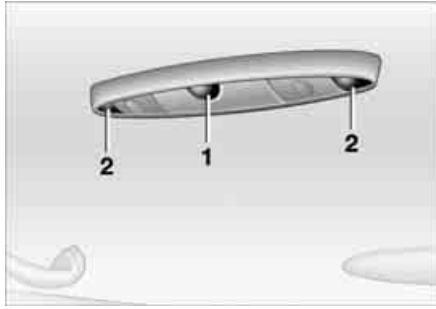

The interior light is controlled automatically.

### Switching the interior lamps on and off manually

Press button 1 briefly.

Permanently turn off interior light:

Press button 1 until the interior light comes on briefly.

To reverse this condition, repeat the procedure.

### Footwell and cargo area lamps

These lamps are controlled in the same way as the interior light.

### Switching the reading lamps on and off

Press button 2.

### Light-emitting diodes (LEDs)

Light-emitting diodes installed behind translucent lenses serve as the light sources for many of the controls and displays in your vehicle. These light-emitting diodes are related to conventional lasers, and legislation defines them as light-emitting diodes, Class 1.



Do not remove the protective lens and avoid staring directly at the unfiltered beam for several hours, as inflammation of the retina could result. ◀

## WASHER/WIPER SYSTEM

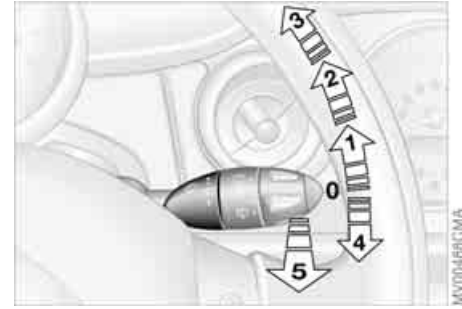

0 Wipers parked

1 Intermittent operation or rain sensor

2 Normal wiper speed

3 Fast wiper speed

4 Brief wipe

5 Clean windshield and headlamps

### Intermittent operation

Not on vehicles with rain sensor.

The interval time for the wipers is dependent on the vehicle speed.

### Rain sensor\*

The rain sensor is located on the windshield, directly in front of the interior rear-view mirror.

When the rain sensor is activated, the

## WASHER/WIPER SYSTEM

windshield wipers are automatically controlled depending on the amount of moisture, including snow, on the windshield.

To activate the rain sensor:

From ignition key position 1:

Lever in position 1.

The wipers move over the windshield once.

To deactivate the rain sensor:

Put lever in position 0.



Switch the rain sensor off when passing through an automatic car wash. Failure to do so could result in damage caused by undesired wiper activation. ◀

### Normal wiper speed

When the vehicle is stationary, the wipers switch automatically to intermittent wiping.



You can have this function activated/deactivated by your MINI Dealer. ◀

### Fast wiper speed

When the vehicle is stationary, the wipers switch automatically to normal wiper speed.



You can have this function activated/deactivated by your MINI Dealer. ◀

### Cleaning windshield and headlamps\*

The system sprays washer fluid against the windshield. The wipers are automatically activated for a brief period.

When the vehicle lighting is on, the headlamps are also cleaned at appropriate intervals.



Do not use the washers if there is any danger that the fluid will freeze on the windshield. For this reason, use an anti-freeze agent, refer to page 98. Do not use the washers when the reservoir is empty, since this could cause damage to the washing pump. ◀

### Heated windshield washer jets\*

The windshield washer jets are heated automatically when the ignition key is in position 2.

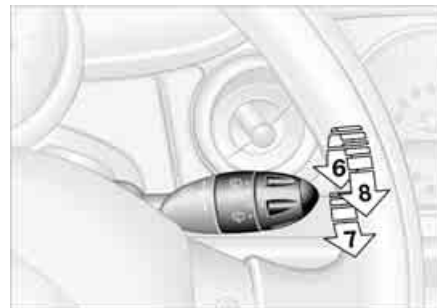

### Rear window wiper

6 Intermittent operation:

Turn the cap to position 6.

The rear window wiper moves across the window a number of times before switching to intermittent operation

### Cleaning rear window

7 Intermittent operation:

Turn the cap to position 7 and hold in place

8 In lever position 0:

Turn the cap to position 8 and hold in place

## CRUISE CONTROL\*

### On the multifunction steering wheel and sports steering wheel

The vehicle maintains and stores any desired speed when driving above approx. 20 mph / 30 km/h. Vehicles with manual transmission must be driving in 3rd gear or higher.

 Do not use cruise control on twisting roads, when high traffic density prevents driving at a constant speed, or when the road surface does not permit driving at a constant speed, e.g. due to snow, rain, ice, loose surfaces. ◀

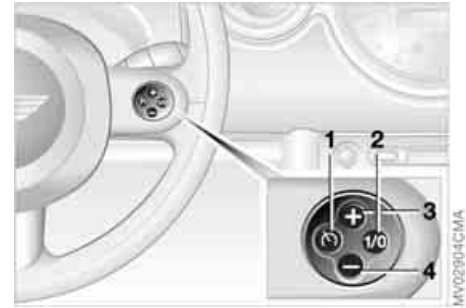
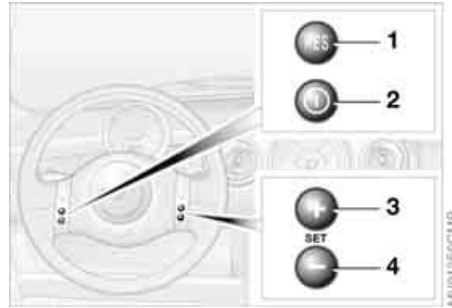

### To activate via the multifunction steering wheel

From ignition key position 1:

Press button 2.

The indicator lamp in the instrument cluster lights up.

Cruise control is active.

### To activate via the sports steering wheel

1. Start the engine

2. Press button 2.

The indicator lamp in the instrument cluster lights up.

Cruise control is active.

### To deactivate

Press button 2 repeatedly until the indicator lamp goes out.

The cruise control is deactivated when the ignition key is turned to position 0.

The stored speed is cleared.

## CRUISE CONTROL\*

### To maintain and store speed or to accelerate

Press button 3.

The system maintains and stores the current vehicle speed. Every time you tap the button, the speed increases by approx.

1 mph / 2 km/h.

Press and hold button 3.

The vehicle accelerates without pressure on the accelerator pedal. When you release the button, the system maintains and stores the current speed.

 If, on a downhill gradient, the engine braking effect is not sufficient, the controlled speed may be exceeded. Speed can drop on uphill grades if the engine output is insufficient. ◀

### To decelerate

Press button 4.

If you are already driving with active cruise control, the speed is decreased by approx. 1 mph / 2 km/h every time you briefly tap the button.

Press and hold button 4.

With the cruise control active, the system automatically reduces the throttle opening to slow the vehicle. When you release the button, the system maintains and stores the current speed.

### To cancel the cruise control

The cruise control is automatically canceled:

- ▷ When the brakes are applied
- ▷ When the clutch pedal is depressed
- ▷ If the cruise speed is either exceeded or not met for an extended length of time, for example if you press the accelerator pedal and exceed the stored speed.

The indicator lamp stays lit.

You can use the cruise control again as required.

On the multifunction steering wheel, the cruise control can be interrupted manually:

When the system is activated, press button 2.

### To continue cruise control

Press button 1.

The vehicle accelerates to and maintains the last speed stored.

## ODOMETER



### 1 Trip odometer

To set to zero:

With ignition key in position 1, press button 2 until the trip odometer is at zero.

### 2 Odometer

You can activate the displays shown in the illustration, with the ignition key in position 0, by pressing button 3 in the display elements.

## TACHOMETER



Do not operate the engine with the needle in the red overspeed zone of the gauge.

To protect the engine, the power is reduced when you approach a certain engine speed in this sector.

## FUEL GAUGE

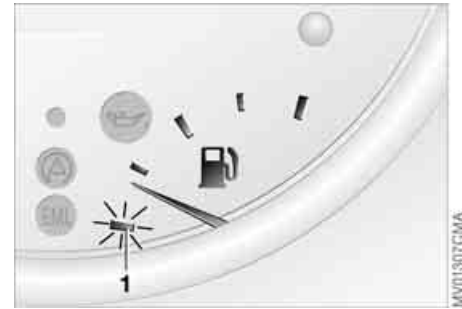

### In the speedometer

If the indicator light 1 begins to be lit continuously, there are approx. 2.1 gallons / 8 liters of fuel in the tank.

Fuel tank capacity:  
approx. 13.2 gallons / 50 liters.

When you switch on the ignition, the indicator lamp lights up briefly to confirm that the system is operational.

If the angle of the vehicle varies, for example when you are driving in mountainous areas, the needle may fluctuate slightly.



Refill the gas tank early. If you drive to the last drop of fuel, engine functions are not guaranteed and damage can occur. ◀



## FUEL GAUGE

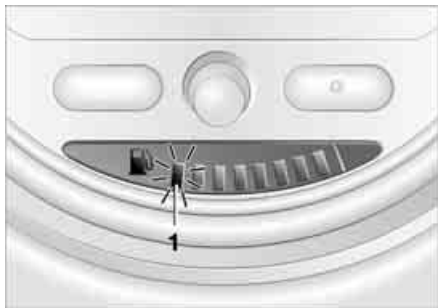

### In the navigation system

 Please also comply with the instructions in the previous section. ◀

If the indicator light 1 changes from orange to red, there are approx. 2.1 gallons / 8 liters of fuel in the tank.

## COOLANT TEMPERATURE GAUGE

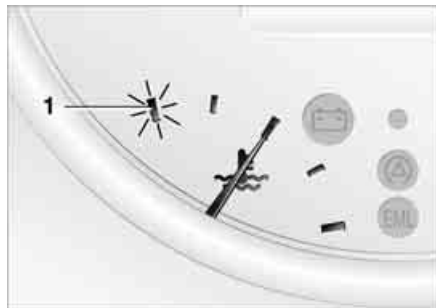

### Low temperature

The needle is at the bottom or on the right of the range.

The engine is still cold. Drive at moderate engine and vehicle speeds.

### Center position

Normal operating temperature of the engine.

### High temperature

As soon as there is a deviation from the center position upwards or to the left:

Drive moderately and at low engine speed. If necessary, switch off the engine and allow it to cool down.

Checking coolant level, refer to page [100](#).

### 1 Red indicator lamp

When you switch on the ignition, warning lamp 1 comes on briefly to confirm that the system is operational.

Lights up while driving:  
Engine is too hot. Switch off the engine immediately and allow it to cool down.

### Navigation system option



Coolant temperature warning lamp in the speedometer lights up while driving:

Engine is too hot. Switch off the engine immediately and allow it to cool down.

## SERVICE INTERVAL DISPLAY



### Remaining distance for service

The distance remaining before the next scheduled service is displayed in miles / kilometers with the ignition key in position 1 or higher. The display also indicates whether an engine oil service and/or an inspection is due.

The onboard computer bases its calculations of the remaining distance on your driving style in the period immediately preceding your data request. The remaining distance display counts backwards in steps of 35 miles / 50 km to the next service. A flashing message and a minus sign in front of the display that again begins counting forwards mean that the service interval has been exceeded.

Please contact your MINI Dealer for an appointment.

The remaining-distance display disappears after approx. 5 seconds and changes to the odometer and trip odometer display.

For more information on the service interval display, refer to page [102](#).

## CLOCK

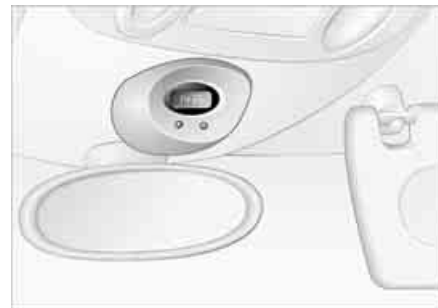

### Settings

From ignition key position 1:

Left button: hours

Right button: minutes.

Move forward in increments:

Press the button

or

fast forward:

Press and hold the button.

Changeover from 24-hour to 12-hour mode:

Press both buttons at the same time for approx. 5 seconds.

## ONBOARD COMPUTER\*

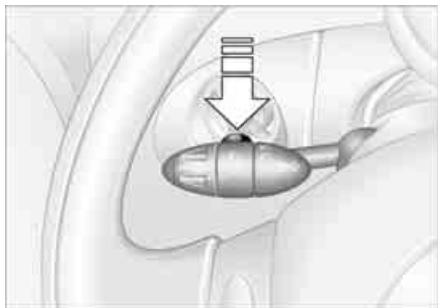

### Ice warning

If the outside temperature falls below approx. 37 °F / +3 °C, the onboard computer automatically switches to the outside temperature display.

In addition, an acoustic signal can be heard and the display flashes for a short time.



The ice warning does not exclude the possibility that surface ice can form at temperatures above 37 °F / +3 °C, e.g. on bridges and shaded roads. ◀

### Mode selection

With the ignition key in position 1 and higher, you can use the button in the turn signal indicator lever to retrieve information from the onboard computer for display in the tachometer. By pressing the button briefly, you can call up a new function for display.

The displays appear in the following order: Outside temperature, range, average consumption and current consumption, average speed and current speed.

Starting with ignition key position 1, the last active setting is displayed.

 If the vehicle is equipped with a navigation system, you will find more information on the onboard computer in the navigation system Owner's Manual. ◀

### Outside temperature

If the vehicle is equipped with a tachometer, but not with an onboard computer, the outside temperature is displayed.



You can have the units °C or °F set by your MINI Dealer. ◀

With navigation system option:

The temperature is displayed in the status line of the navigation system, refer to the Owner's Manual for the navigation system.

### Current vehicle speed

If the vehicle is equipped with a tachometer, but not with an onboard computer, the current vehicle speed is displayed.

With the ignition key in position 1 and higher, you can use the button in the turn signal indicator lever to call this up in the tachometer display. Briefly press the button to switch the display from the outside temperature to the current vehicle speed.

## ONBOARD COMPUTER\*

### Range

The onboard computer bases its calculations for the cruising range on the driving style and on the remaining fuel in the tank.



If the range displayed is less than 35 miles / 50 km, be sure to refuel; otherwise engine functions are not guaranteed and damage could occur. ◀

### Average speed, average fuel consumption

Press the button in the turn signal indicator lever for a longer period.

The displayed average speed value and consumption value are recalculated.

Any time spent when the vehicle is stationary and the engine is shut off is ignored for the calculation.



You can have an other unit of measurement set by your MINI Dealer. ◀

### Current fuel consumption

The current consumption value is calculated and displayed on the basis of your driving style.



You can have a different unit of measurement set by your MINI Dealer. ◀

## ALL SEASON TRACTION CONTROL (ASC)\*

### The concept

This system optimizes driving stability and traction, especially when just starting off, when accelerating or when cornering.

ASC recognizes the danger present in traction loss and will increase driving stability and traction by reducing the engine's output and, if necessary, by applying the brakes to the front wheels.

ASC is operational each time you start the engine. It contains the following functions:

- ▷ Antilock Brake System (ABS)
- ▷ Cornering Brake Control (CBC)
- ▷ Electronic Brake Force Distribution (EBD).

 The laws of physics cannot be repealed, even with ASC. An appropriate driving style always remains the responsibility of the driver. Avoid using the additional safety margin provided by the system as an excuse for taking unnecessary risks.

Do not make any modifications to the ASC system. Allow only authorized technicians to perform service procedures on the ASC. ◀

### Indicator lamp



The indicator lamp in the display elements will go out shortly after the ignition has been switched on, refer to pages 16, 17.

If the indicator lamp flashes:  
ASC controls the drive and braking forces.

If the indicator lamp fails to go out after the engine is started, or if it comes on during normal driving and stays on:  
The system is defective or was turned off using the button.

The described stabilizing operations are no longer available.

You can, however, drive the vehicle normally without ASC.

In the event of a malfunction, please see your MINI Dealer, refer to pages 16, 17.

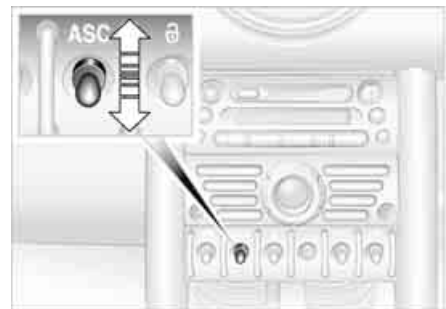

### To switch off the ASC

Briefly press the switch.  
The indicator lamp stays lit.

When driving with snow chains or to 'rock free' in snow, it can be helpful to switch off the ASC for a brief period.

 To maintain vehicle stability, always drive with the ASC switched on whenever possible. ◀

### To switch the ASC back on

Briefly press the switch once again.  
Indicator lamp goes out.

## DYNAMIC STABILITY CONTROL (DSC)\*

### The concept

This system optimizes driving stability and traction, especially when just starting off, when accelerating or when cornering. It also maintains driving stability even in critical driving situations.

DSC recognizes unstable vehicle conditions, such as understeering or oversteering, and, as far as is possible within the laws of physics, helps keep the vehicle on a steady course by reducing the rpms and by brake applications to the individual wheels.

The DSC is operational every time you start the engine. It contains the following functions:

- ▷ All Season traction Control (ASC)
- ▷ Antilock Brake System (ABS)
- ▷ Cornering Brake Control (CBC)
- ▷ Electronic Brake Force Distribution (EBD).

 The laws of physics cannot be repealed, even with DSC. An appropriate driving style always remains the responsibility of the driver. Avoid using the additional safety margin provided by the system as an excuse for taking unnecessary risks. Do not make any modifications to the DSC system. Allow only authorized technicians to perform service procedures on the DSC. ◀

### Indicator lamp



The indicator lamp in the display elements will go out shortly after the ignition has been switched on, refer to pages 16, 17.

If the indicator lamp flashes:  
DSC controls the drive and braking forces.

If the indicator lamp fails to go out after the engine is started, or if it comes on during normal driving and stays on:  
The system is defective or was turned off using the button.

The described stabilizing operations are no longer available.

The vehicle will remain completely operational, however, without DSC.

In the event of a malfunction, please see your MINI Dealer, refer to pages 16, 17.

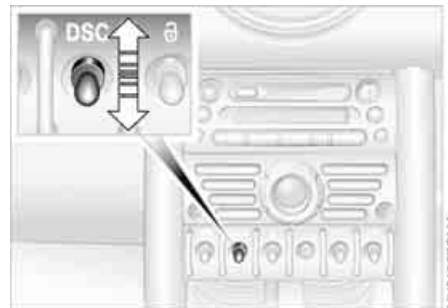

### To switch off the DSC

Briefly press the switch.  
The indicator lamp stays lit.

When driving with snow chains, it may be effective to switch off the DSC for a brief period.



To maintain stability, always drive with the DSC switched on whenever possible. ◀

### To switch the DSC back on

Briefly press the switch once again.  
Indicator lamp goes out.

# ANTILOCK BRAKE SYSTEM (ABS)

## The concept

The ABS keeps the wheels from locking while braking, thereby enhancing active driving safety.

ABS also includes Electronic Brake Force Distribution (EBD).

## Braking with ABS

To achieve optimal performance from ABS when reacting to critical situations, you should apply maximum pressure to the brake pedal – panic stop.

Since the vehicle remains maneuverable, you can still go around any obstacles with the smallest possible steering movements.

Pulsation of the brake pedal in conjunction with the sound of hydraulic regulation indicates to you that you are driving at the limit and reminds you to readapt your vehicle's speed to road surface conditions.

## Cornering Brake Control (CBC)

Cornering Brake Control (CBC) is an enhancement of ABS that improves vehicle stability especially when braking during cornering.

When the vehicle is being braked, the rear wheels are relieved from load, and this can cause the vehicle to oversteer in curves. CBC counteracts this by making use of unilateral braking pressure to generate a stabilizing counter torque while braking outside of the ABS control range.

## Electronic Brake Force Distribution (EBD)

In order to achieve a short braking distance when the vehicle is fully loaded, your vehicle is equipped with relatively large brakes on the rear axle. EBV continuously monitors the speeds of the rear wheels in relation to the front wheels in order to prevent overbraking of the rear wheels even when the vehicle has a light load. If the rear wheels tend to lock, the EBV controls their slip, ensuring operating stability.

# FLAT TIRE MONITOR

## The concept

As you drive, the Flat Tire Monitor keeps track of the tire inflation pressure in all four tires. The system alerts you when there is a substantial pressure loss in one of the tires relative to another.

The tire inflation pressures are monitored based on the speeds of the four wheels in relation to one another. A flat tire is detected as the result of differences in certain speed ratios, and a warning is generated.

## System requirements

So that the system can 'familiarize' itself with the correct inflation pressure, please do the following:

1. Check the tire inflation pressure in all tires
2. Compare them with the inflation pressure table, refer to page 88, and adjust the pressures if necessary
3. Initializing the system.

## System limitations

 The Flat Tire Monitor cannot alert you to severe and sudden tire damage caused by external factors, nor does it detect the gradual and minor loss of pressure in all four tires. ◀

On the other hand, the following situations could lead to a delayed detection of pressure loss or to the system not functioning:

- ▷ Driving on snow-covered or slippery roads
- ▷ Performance-oriented driving: slip at the drive wheels, high rates of lateral acceleration
- ▷ When driving with snow chains, false warnings and undetected pressure loss may occur
- ▷ When driving with a space-saver spare tire, the Flat Tire Monitor cannot function.

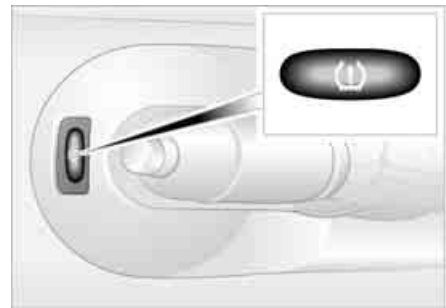

## Initializing the system

 The system must be re-initialized immediately after changing a tire and wheel, or after correcting the pressure in any tire. This requires a bit of driving. ◀

1. Before a journey, start the engine, but do not start driving
2. Press the button long enough for the indicator lamp in the display elements to light up for a few seconds
3. Drive off.

It takes a few minutes before the Flat Tire Monitor can detect a flat tire and issue an alert.

 Do not initialize the system if you are driving with snow chains or a space-saver spare tire. ◀



## FLAT TIRE MONITOR

### Flat tire

Indicator lamp:



The indicator lamp in the display elements flashes. In addition, an acoustic signal sounds.

1. Reduce speed and stop the vehicle with caution. Avoid hard brake applications and steering maneuvers
2. Determine which tire is damaged  
 If this cannot be determined, contact your MINI Dealer.◀
3. Replace the damaged tire, refer to Changing tires on page [117](#), or repair the flat tire using the MINI Mobility System, refer to page [121](#).

Vehicles with Run Flat tires:

1. Reduce vehicle speed carefully to under 50 mph / 80 km/h. Avoid hard brake applications and steering maneuvers. Do not exceed a speed of 50 mph / 80 km/h



Since Run Flat tires are reinforced on the flanks, it is usually not possible to detect a loss of pressure from the outside, refer to Run Flat tires on page [93](#).◀

2. To continue driving, follow the instructions on driving with damaged tires on page [93](#).

### System malfunction

Indicator lamp:



The symbol in the instrument cluster lights up. The Flat Tire Monitor is malfunctioning or out of order.

Please contact your MINI Dealer.

## PARK DISTANCE CONTROL (PDC)\*

### The concept

The PDC assists you when you back into a parking space. A signal tone tells you the current distance to an object behind your vehicle. To do this, four ultrasonic sensors in the rear bumper measure the distance to the nearest object.

The sensors on each side have a range of approx. 2 ft / 60 cm, the middle sensors one of approx. 5 ft / 1.5 m.

 PDC is a parking aid that can identify objects if they are approached slowly, as is generally the case when parking. Avoid driving towards objects rapidly; due to underlying physical principles, the system may otherwise alert you too late for you to take evasive steps. ◀

### Automatic function

With the ignition key in position 2, the system starts to operate automatically about one second after you select reverse gear or place the selector lever in position R.

 Wait for this one second before you drive backwards. ◀

The system is deactivated when you shift away from Reverse.



You can have a signal tone set by your MINI Dealer as a confirmation that PDC has been activated. ◀

### Acoustical signals

The distance to an object is indicated by a tone sounding at intervals. As the distance between vehicle and object decreases, the intervals between the tones become shorter. A continuous tone indicates the presence of an object less than 8 in / 20 cm away.

The warning signal is canceled after approx. three seconds if the distance to the object remains constant during this time, for instance if you are moving parallel to a wall.

### Malfunction

System malfunctions will be indicated by a continuous high-pitched tone when the system is activated the first time. Please have your MINI Dealer resolve the problem.

### Volume control

The volume of the Park Distance Control signal can be adjusted from level 1, soft, to level 6, loud.



The volume can be set by your MINI Dealer. ◀

### System limitations



Even with PDC, final responsibility for estimating the distance between the vehicle and any objects always remains with the driver.

Even when sensors are involved, there is a blind spot in which objects cannot be detected. Recognition of some objects can be beyond the limits of physical ultrasonic measurement, for example with towing bars or hitches or with thin or wedge-shaped objects. Moreover, low objects that have already been detected, such as a curb edge, can disappear out of the range of the sensors before a continuous tone sounds. Loud sources of sound outside and inside your vehicle can drown the PDC signal tone. ◀



Keep the sensors clean and free of ice or snow in order to ensure that they will continue to operate effectively. Do not apply high pressure spray to the sensors for a prolonged period of time. Always maintain a distance which is greater than 4 in / 10 cm. ◀

## AIRBAGS

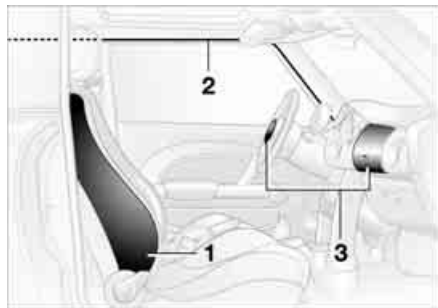

- 1 Side airbags in seatback on the driver and passenger side: front
- 2 Head airbags on the driver and passenger sides for both rows of seats: front/rear
- 3 Front airbags on the driver and passenger sides

### Protective effect

The front airbags supplement the safety belts by providing additional protection for the driver and front passenger in the event of a frontal collision in which the protection afforded by the belts alone may no longer be sufficient.

When needed, the head and side airbags help to furnish protection in the event of side impact.

Each of the side airbags is designed to help support the seat occupant's upper body.

The airbags are designed to not be triggered in certain types of collisions, e.g. in minor accidents, certain kinds of vehicle rollover and rear impact.

For information on the ideal seating position, refer to page 31.



Do not apply adhesive materials to the cover panels of the airbags, cover them or modify them in any other way. Do not fit covers, cushions or other items to the front seats that have not been specially approved for seats with side airbags. Do not hang clothing, e.g. jackets, over the backrests. Do not attempt to remove the airbag restraint system from the vehicle. Do not make any changes yourself to the individual components and wiring. This includes the padded covers of the steering wheel, instrument panel and roof supports, as well as the sides of the roofliner and the original backrest covers on the front seats. Do not attempt to remove or dismantle the steering wheel. Do not touch the individual components directly after the system has been triggered, as otherwise there is a danger of burns. In the event of malfunctions, immobilization or use, i.e. triggering, of the airbag restraint system

in accordance with its intended function, please commission a MINI Dealer with the inspection, repair or disassembly. Unprofessional attempts to service the system could lead to failure in an emergency or undesired airbag activation, either of which could result in personal injury. In view of the applicable safety regulations, please arrange for your MINI Dealer to dispose of the airbag generators. ◀

Airbag warning information is also provided on the sun visors.

### Indicator lamp



The indicator lamp in the display elements shows the status of the entire airbag system and the seat belt tensioners starting from ignition key position 1.

System operational:

- ▷ The indicator lamp comes on briefly.

System malfunction:

- ▷ The indicator lamp does not come on starting from ignition key position 1
- ▷ The indicator lamp stays lit
- ▷ The indicator lamp lights up while driving.

## AIRBAGS



A system malfunction could prevent the airbags from deploying in response to a severe impact occurring within the system's normal triggering range. Please have the airbag system checked as soon as possible by your MINI Dealer. ◀

## AIR CONDITIONING SYSTEM\*

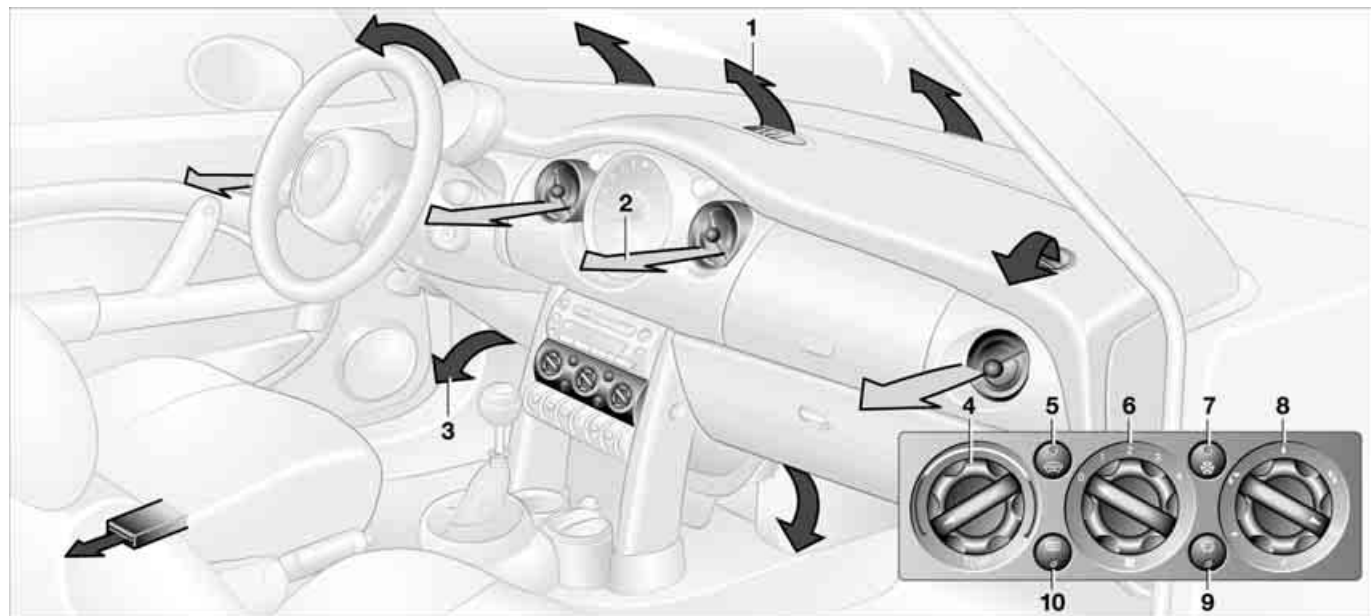

- 1 Air onto the windshield and onto the side windows
- 2 Air for the upper body area 69
- 3 Air for the front and rear footwells

- 4 Temperature 68
- 5 Windshield heating 68
- 6 Blower for air supply 68
- 7 Air conditioning 68

- 8 Air distribution 68
- 9 Recirculated air mode 68
- 10 Rear window defroster 68

MV01680CTMA

## AIR CONDITIONING SYSTEM\*

### Air supply



You can select blower speeds from 1 to 4. Position 0: fan is turned off. The button for recirculated air mode fully blocks the supply of air from outside.

Heating and ventilation operate as of position 1.

### Temperature



Turn to the right, red, to increase the temperature of the passenger compartment.

Rapid heating: turn to the extreme right. Then select a pleasant interior temperature.

### Air distribution



Air distribution in upper body region →, upper body region and footwell ↗, footwell ↓, footwell and windows ↕, and windows ☼.

All intermediate positions are possible, refer to illustration and overview on page 67.

### Rear window defroster



Rear window defroster switched on:

Indicator lamp lights up.

As long as the indicator lamp is lit, the heating operates at high power output: rapid defrosting.

Indicator lamp goes out.

The heating continues to run with reduced power output and then switches itself off automatically.

### Windshield heating\*



Windshield heating switched on:

Indicator lamp lights up.

As long as the indicator lamp is lit, the heating operates at high power output: rapid defrosting.

Indicator lamp goes out.

The heating continues to run with reduced power output and then switches itself off automatically.

### Air conditioning



Air conditioner switched on: indicator lamp lights up.

The air is cooled and dehumidified and – depending on the temperature setting – rewarmed.

Condensation on the windows is reduced when the air conditioning is turned on.



When the air conditioner is operating, condensation is formed which then exits under the vehicle. Traces of condensed water on the ground are therefore normal. ◀

### Recirculated air mode



Supply of outside air into the vehicle is blocked:

Indicator lamp lights up.

The air within the vehicle is recirculated.



Do not run the recirculated air mode over a longer period of time, as the air quality in the vehicle's interior will otherwise diminish. ◀



If the windows fog up in the recirculated air mode, turn the recirculated air mode off and if necessary increase the air supply. ◀

## AIR CONDITIONING SYSTEM\*

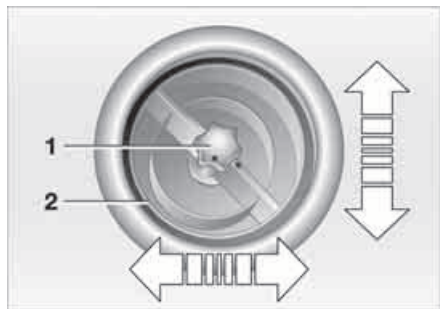

### Microfilter\*

The microfilter removes dust and pollen from the incoming or recirculated air.

Your MINI Dealer will replace it during routine maintenance. A substantial reduction in the air supply indicates that the filter must be replaced before scheduled maintenance.



### Draft-free ventilation

Air supply for the upper body area:

Button 1: air outlets can be opened and closed by turning.

The points indicate the position in each case.

Nozzle 2: change the direction of the airflow by swiveling.

### Defrosting and demisting windows

1. Set the rotary blower speed control for the airflow rate to position 4
2. Turn the rotary temperature control completely to the right, red
3. Rotary switch for air distribution in position .  
Condensation is removed from the windows more quickly by activating the air conditioning
4. To defrost the rear window: switch on the rear window defroster and, if required, the windshield heating.

## AUTOMATIC CLIMATE CONTROL\*

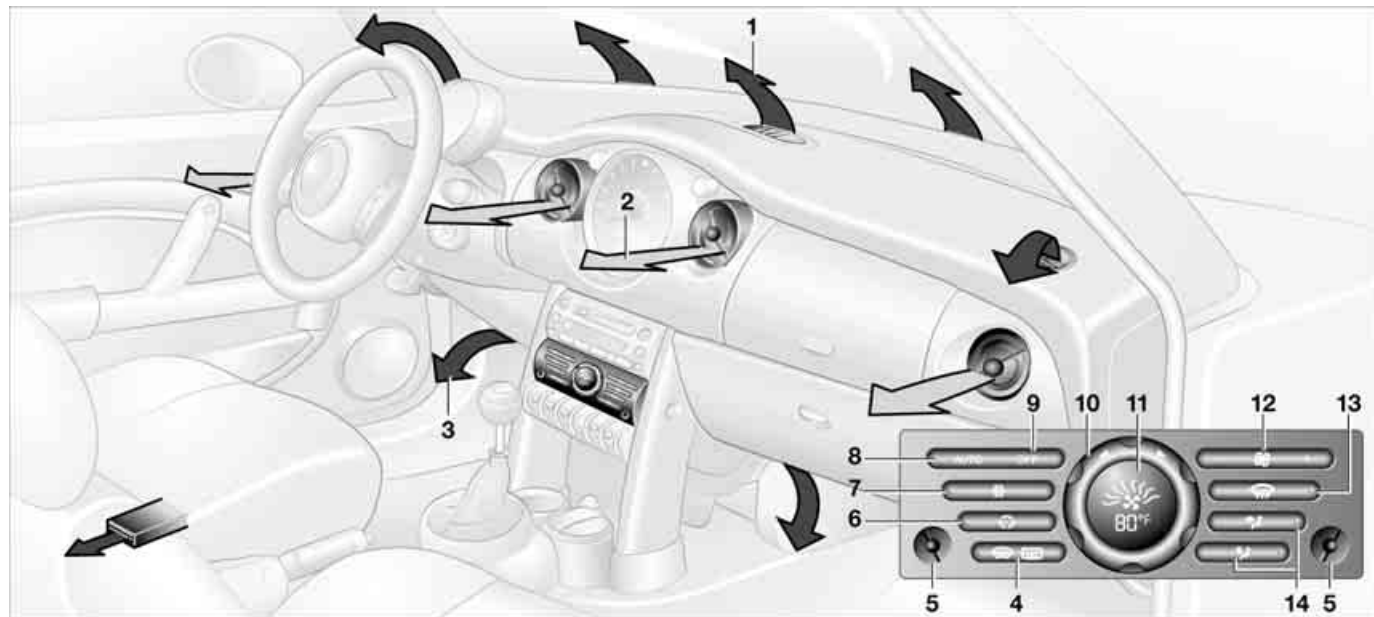

1 Air onto the windshield and onto the side windows

2 Air for the upper body area 72

3 Air for the front and rear footwells

4 Rear window defroster and windshield heating 71

5 Interior temperature sensor, please keep clear and unobstructed

6 Recirculated air mode 71

7 Air conditioning 71

8 Automatic air distribution and supply 71

9 Switching the automatic climate control on/off 71

10 Temperature 71

11 Display for temperature and air supply 71

12 Blower for air supply 72

13 Defrosting and demisting the windshield and side windows 72

14 Individual air distribution 72



## AUTOMATIC CLIMATE CONTROL\*

### Automatic air distribution and supply

 Automatic program (AUTO):  
Indicator lamp lights up.

Automatic adjustment of the air distribution and supply, and adaptation of the specified temperatures to external influences, i.e. outside temperature and sunlight.

In the automatic program (AUTO), the air conditioner is activated automatically.

 You can change the unit from °C to °F by keeping extended pressure on the button. ◀

### Switching the automatic climate control on/off

 The blower, heating and air conditioner are switched off.

To switch the automatic climate control on again: Press any button of the automatic climate control.

### Air conditioning

 Air conditioner switched on: indicator lamp lights up.

The air is cooled and dehumidified and – depending on the temperature setting – rewarmed.

In the automatic program (AUTO), the air conditioner is activated automatically. Condensation on the windows is reduced when the air conditioning is turned on.

 Condensation forms in the air conditioning system during operation, and then exits under the vehicle. Traces of condensed water on the ground are therefore normal. ◀

### Recirculated air mode

 Supply of outside air into the vehicle is blocked: indicator lamp lights up.

The air within the vehicle is recirculated. In the automatic program (AUTO) in hot weather conditions, the recirculated air mode is activated temporarily to enable faster cooling.

 Do not run the recirculated air mode over a longer period of time, as the air quality in the vehicle's interior will otherwise diminish. ◀

 If the windows fog up in the recirculated air mode, turn the recirculated air mode off and if necessary increase the air supply. ◀

### Rear window defroster and windshield heating\*

 Rear window defroster and windshield heating switched on:  
Indicator lamp lights up.

As long as the indicator lamp is lit, the heating operates at high power output – rapid defrosting.

Indicator lamp goes out.  
The heating continues to run with reduced power output and then switches itself off automatically.

### Temperature

 Setting the temperature:  
Move or turn the wheel in the appropriate direction to increase the temperature step by step.

The figures in the display provide a general indication of interior temperature. When you start the vehicle, the system ensures that the selected temperature is achieved as quickly as possible and then maintained.

 Permanent heating with maximum power output at temperature selection HI. Permanent cooling at LO. ◀

## AUTOMATIC CLIMATE CONTROL\*

### Air supply



Press the left or right half of the button: the air supply varies.

### Defrosting and demisting windows



Press the button briefly. The indicator lamp flashes.

Ice and condensation are rapidly removed from the rear window, windshield and side windows. Condensation is removed from the windows more quickly by activating the air conditioning.

The rear window defroster/windshield heating is switched on automatically. It can be switched off again separately.

Press the button for a longer period. The indicator lamp stays lit. Permanent air supply to the windshield and side windows. The air supply can be directed both to the windows and to the footwell simultaneously.

The rear window defroster/windshield heating is switched off.

### Individual air distribution



Combine the air distribution yourself. This switches off the automatic program.

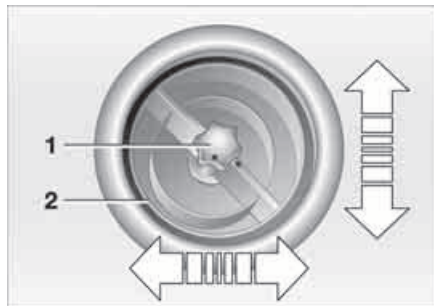

MV00524CMA

### Microfilter/activated-charcoal filter

The microfilter removes dust and pollen from the incoming or recirculated air. The activated-charcoal filter provides additional protection by filtering gaseous pollutants from the outside air.

Your MINI Dealer replaces this combined filter as a standard part of your scheduled maintenance. A substantial reduction in the air supply indicates that the filter must be replaced before scheduled maintenance.

### Draft-free ventilation

Air supply for the upper body area:

Button 1: air outlets can be opened and closed by turning.

The points indicate the position in each case.

Vent 2: change the direction of the airflow by swiveling.

## GLOVE COMPARTMENT

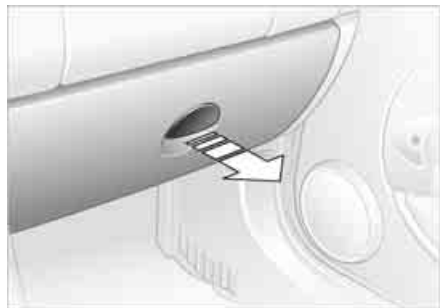

To open:  
Pull the handle.  
The light goes on.

To close:  
Fold the door up.

 To prevent injury in the event of an accident, close the glove compartment immediately after use. ◀



### Ventilation

Turn the rotary switch to a horizontal position:

The vents are open.

Turn the rotary switch to a vertical position, see arrow:

The vents are closed.

 Depending on the temperature setting of the air conditioning or the automatic climate control, high temperatures may result in the glove compartment. ◀

## ASHTRAY, DRINKS HOLDERS

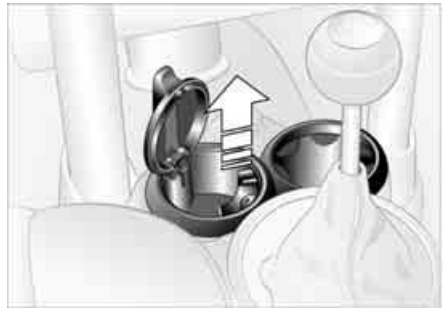

### Ashtray

The ashtray is located in one of the beverage holders in the center console.

In the rear, an ashtray can also be fitted in the beverage holder at the end of the center console.

### Beverage holders

There are two beverage holders at the front of the center console. Another is located at the end of the center console in the rear.

## CIGARETTE LIGHTER, 12 V POWER SUPPLY

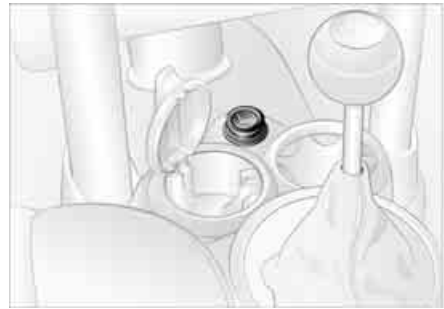

A second 12 V socket is on the left-hand side of the cargo area.

When the vehicle is equipped with a MINI Mobility System, the 12 V socket is also for supplying the compressor.

From ignition key position 1:

Press the cigarette lighter in.

Remove as soon as the lighter jumps back out.



Hold or touch the hot cigarette lighter by the knob only. Holding or touching it in other areas could result in burns. ◀

### Cigarette lighter socket, 12 V power supply

Suitable for attaching power supplies for flashlights, car vacuum cleaners, etc., up to a rating of approx. 200 watts at 12 volts. Avoid damaging the socket with plugs of different shapes or sizes.

## CARGO AREA

### Cargo area cover

When the tailgate is opened, the cargo area cover is also raised.

 Never place any heavy or hard objects on the cargo area cover; otherwise occupants could be injured during braking maneuvers. ◀

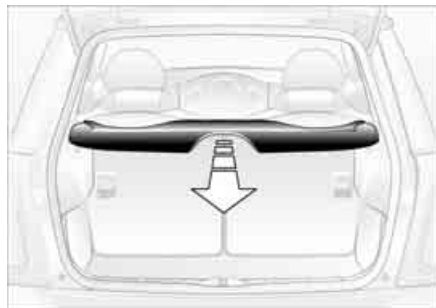

### Removal

To load bulky luggage, the compartment cover can be removed.

1. Remove the retaining straps on the tailgate
2. Pull the cargo area cover out towards the rear.

### Foldable rear backrest

1. Pull lever
2. Fold the rear backrest forwards.

 When folding the backrest back into its original position, always ensure that the catch engages securely. A loose backrest might fail to prevent cargo from entering the passenger compartment during sudden braking or evasive maneuvers, posing a potential hazard to occupants. ◀

## LOADING CARGO

 Avoid overloading the vehicle so that the permitted load on the tires is not exceeded. Overloading can lead to overheating and damage inside the tires. Depending on the circumstances, this can result in sudden air loss. ◀



### Determining cargo limit

1. Locate the following statement on your vehicle's placard:

 The combined weight of occupants and cargo should never exceed XXX kg or YYY lbs, as this could otherwise result in damage to the vehicle and unstable driving conditions. ◀
2. Determine the combined weight of the driver and passengers that will be riding in your vehicle
3. Subtract the combined weight of the driver and passengers from XXX kilograms or YYY pounds

4. The resulting figure equals the available amount of cargo and luggage load capacity.

For example, if the XXX amount equals 1,400 lbs. and there will be four 150 lbs. passengers in your vehicle, the amount of available cargo and luggage load capacity is 800 lbs.:

1,400 lbs. minus 600 lbs. = 800 lbs.

5. Determine the combined weight of luggage and cargo being loaded on the vehicle. That weight may not safely exceed the available cargo and luggage load capacity calculated in Step 4
6. If your vehicle will be towing a trailer, load from your trailer will be transferred to your vehicle. Consult the manual for transporting a trailer to determine how this may reduce the available cargo and luggage load capacity of your vehicle.

## LOADING CARGO

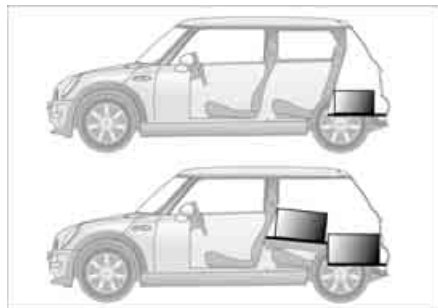

### Stowing cargo

- ▷ Place heavy cargo as far forward as possible, directly behind the backrests, and as low as possible
- ▷ Cover sharp edges and corners
- ▷ Do not pile objects higher than the top edge of the backrest

- ▷ For very heavy cargo when the rear seat is unoccupied, fasten each safety belt in the opposite buckle. This provides additional stabilization for the rear backrests.

### Securing the load

- ▷ Secure smaller and lighter items using the cargo area net\* or elastic straps
- ▷ For large, heavy items, see your MINI Dealer for load-securing devices\*. Lashing eyes are provided at the inner corners of the cargo area for attaching these load-securing devices. Comply with the information enclosed with the load-securing devices.

## ROOF-MOUNTED LUGGAGE RACK\*



Always position and secure the load carefully. If you do not, it can endanger the passengers during braking or evasive maneuvers.

Do not exceed the permissible gross weight and axle load, refer to page 134; otherwise the vehicle's operating safety is no longer assured and it will not be in compliance with the certification regulations.

Do not stow heavy or hard objects in the passenger compartment without first securing them. Otherwise they would be thrown around during braking and evasive maneuvers and endanger the occupants. ◀



When loading a roof-mounted luggage rack, ensure that there is sufficient space for the movement of the glass sunroof and that no objects protrude into the swiveling area of the tailgate, as otherwise damage can occur. ◀



Do not secure the roof-mounted luggage rack to the trim panels/strips: the lack of a secure hold could lead to damage or accidents. ◀



Special roof-mounted luggage racks for your MINI are available as accessories from your MINI Dealer. ◀







OVERVIEW

OVERVIEW

CONTROLS

CONTROLS

OPERATION, CARE, MAINTENANCE

OPERATION

OWNER SERVICE PROCEDURES

REPAIRS

TECHNICAL DATA

DATA

INDEX

INDEX

## BREAK-IN PROCEDURES

To ensure that your vehicle provides maximum economy throughout a long service life, we request that you comply with the following information:

### Engine

Up to 1,250 miles / 2,000 km:

- ▷ Drive at various vehicle and engine speeds
- ▷ Do not exceed an engine speed of 4,500 rpm or a vehicle speed of 95 mph / 150 km/h.
- ▷ Absolutely avoid using the full-throttle or kickdown position for the accelerator.

Up to 1,250 miles / 2,000 km:

Engine and road speeds can be gradually increased.

You should also comply with these break-in procedures if the engine has to be replaced at a later point.

### Tires

Due to technical factors associated with their manufacture, tires do not achieve their full traction potential until after an initial break-in period. Therefore drive carefully during the first 200 miles / 300 km.

### Brake system

Approx. 300 miles / 500 km must be driven before the brake pads and rotors achieve the optimum pad-surface and wear patterns required for trouble-free operation and an extended service life.

### Clutch

Roughly 300 miles / 500 km must be driven before the clutch starts to operate at optimum efficiency. Remember to engage the clutch carefully during this initial period.

## GENERAL DRIVING NOTES

### Parking the vehicle

Condensation forms in the air conditioner system during operation, and then exits under the vehicle. Traces of condensed water on the ground are therefore normal.

### Brakes

 Do not rest your foot on the brake pedal while driving. Even light but consistent pedal pressure can lead to high temperatures, brake wear and possibly even brake failure. ◀

### Hydroplaning

 When driving on wet or slushy roads, reduce road speed. If you do not, a wedge of water can form between tires and road surface. This phenomenon is characterized by a partial or complete loss of contact between the tires and the road surface. The ultimate results are loss of steering and braking control. ◀

### Driving through water

 Do not drive through water on the road if it is deeper than 1 ft / 30 cm, and then only at walking speed at the most. Otherwise, the vehicle's engine, the electrical systems and the transmission may be damaged. ◀

### Clothes hooks

 When suspending clothing from the hooks, ensure that they will not obstruct the driver's vision. Do not hang heavy objects on the hooks. If you do so, they could cause personal injury during braking or evasive maneuvers. ◀

### High temperatures

 High temperatures occur in any vehicle equipped with a catalytic converter. Do not remove the heat protection plates fitted in the area of the exhaust system and do not apply body-cavity protectant to this area. When driving, standing at idle, and parking the vehicle, take care to avoid contact between the hot exhaust system and flammable materials, e.g. hay, grass, leaves, etc. Such contact could lead to a fire resulting in serious personal injury and property damage. ◀

## REFUELING

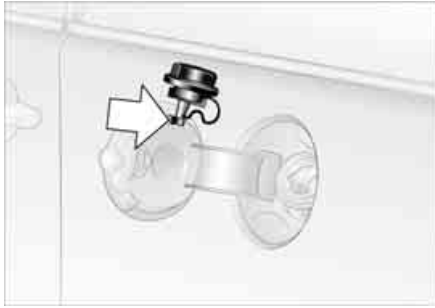

**⚠** Always switch off the engine before refueling. If you do not, fuel cannot be filled into the tank and the SERVICE ENGINE SOON lamp may come on. ◀

1. Open the fuel filler door
2. Turn the gas cap counterclockwise
3. Put the gas cap in the bracket attached to the fuel filler door.

**⚠** Always observe all applicable precautions and regulations when handling fuels. Never carry spare fuel containers in your vehicle. Whether empty or full, these containers can leak, cause an explosion, and lead to fire in the event of a collision. ◀



### Unlocking manually

In the event of an electrical malfunction, the gas cap can be unlocked manually.

1. Remove the side trim panel on the left-hand side of the cargo area.  
Remove the first aid pouch
2. Pull the white lever toward the rear.  
The central locking system releases the gas cap
3. Open the fuel filler door.

### Simple and environmentally friendly

**⚠** Always observe all safety precautions posted at the service station when handling fuel. ◀

When refueling, insert the filler nozzle completely into the filler pipe. Pulling the nozzle out of the pipe during refueling:

- ▷ Results in premature pump shutoff
- ▷ Will reduce the effect of the fuel vapor recovery system on the pump.

As long as the filler nozzle is used properly, the fuel tank is full whenever the nozzle shuts off the first time.

## REFUELING

### Close the tank

1. Put on gas cap
2. Turn gas cap clockwise until it clicks
3. Close fuel filler door.

Fuel tank capacity:

Approx. 13.2 gallons / 50 liters, of which approx. 2.1 gallons / 8 liters are reserve capacity.



Close the gas cap carefully after refuelling until a click is heard.

While closing, be sure not to squeeze the strap which is fastened to the cap.

US models only:

A loose or missing cap will activate the message CHECK GAS CAP in the Check Control\* or the Check Gas Cap lamp\*. ◀



Do not drive until the fuel tank is totally empty. Otherwise engine operations are not guaranteed and damage could occur. ◀

## FUEL SPECIFICATIONS

The engine uses lead-free gasoline only.

Required fuel:

▷ Premium Unleaded Gasoline,

min. 91 AKI.

AKI = Anti Knock Index.



Do not use leaded fuels. The use of leaded fuels will cause permanent damage to the emissions-control system's oxygen sensor and the catalytic converter. ◀

## BRAKE SYSTEM

### Brake fluid level

If the brake fluid level is too low and brake pedal travel has become longer, there may be a defect in one of the brake system's hydraulic circuits.

 Proceed to the nearest MINI Dealer. Higher brake application pressure may be necessary under these conditions, there may be a slight pull to one side, and brake pedal travel may be longer. Please remember to adapt your driving style accordingly. ◀

### Disc brakes

When the vehicle is driven only occasionally, during extended periods when the vehicle is not used at all, and in operating conditions where brake applications are less frequent, there is an increased tendency for corrosion of the brake rotors and accumulation of contamination on the brake pads. This occurs because the minimal pressure that must be exerted by the pads to clean the rotors by brake applications is not reached.

Corrosion on brake rotors is signaled by a running or pulsation during braking; even extended subsequent braking will not cure this phenomenon.

It is a good idea to periodically dry the brakes with a gentle application when driving in rain and on wet roads. Monitor traffic conditions to ensure that this maneuver does not endanger other road users. The resulting heat dries the brake rotor and the brake pads. Then if braking effect is needed, it is immediately available.

Extended or steep mountain descents should be driven in the gear or in the driving position in which only minimal periodic brake application is required. This helps avoid placing excessive loads on the brake system. Stay within the allowable speed range, refer to page 54.

 Do not coast with the clutch pressed or with the transmission or selector lever in Neutral. Do not coast with the engine switched off. The engine provides no braking effect when the transmission is in Neutral, and there is no power-assist for braking when the engine is switched off. ◀

### Brake pads

Brake pad sensors in the left brake pads of the front axle and in the right brake pads of the rear axle monitor the brake pad condition. When the brake pads reach the wear limit, the brake wear warning lights up, refer to page 16.

 For your own safety: use brake pads which the manufacturer of your MINI has approved for your particular vehicle model. The manufacturer of your MINI cannot evaluate non-approved brake pads to determine if they are suitable for use, and therefore cannot ensure the operating safety of the vehicle in the event of their use. ◀



## TIRE INFLATION PRESSURE

### Information for your safety

It is not merely the tire's service life, but also driving safety and driving comfort that depend on the condition of the tires and the maintenance of the specified tire pressure.

 Check tire inflation pressures regularly, including the space-saver spare tire: at least twice a month and before long journeys. Failure to observe this precaution can result in incorrect tire pressures, which cause unstable handling response as well as tire damage, and can ultimately lead to an accident. Do not drive with deflated, i.e. flat, tires except if Run Flat tires are fitted. A flat tire greatly impairs steering and braking response, and can lead to complete loss of control over the vehicle. ◀

### Checking tire inflation pressures

Check the tire inflation pressures only on cold tires. This means after driving a maximum of 1.25 miles / 2 km or when the vehicle has been parked for at least 2 hours. Warm tires have higher pressures.

 After correcting the tire inflation pressure, reinitialize the Flat Tire Monitor, refer to page 62. ◀



### Tire inflation pressures for original tires

The tire inflation pressures in psi and kilopascal are given on the placard on the B-pillar that is visible when the driver's door is open.

### Inflation pressures for other tires

In the following tire pressure table, all pressures are specified in the psi / kilopascal units of pressure and apply to tires at ambient temperature.

 In order to determine the correct inflation pressures for your tires, refer to the values for the tire size in question. ◀

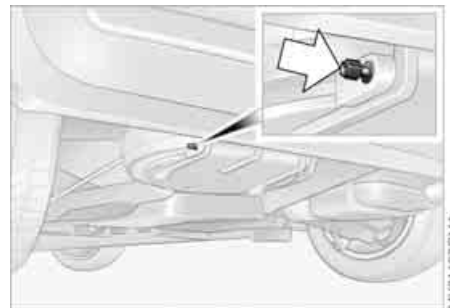

### Checking the inflation pressure on the space-saver spare tire

Behind the bumper there is a valve extension accessible from the outside for checking the inflation pressure.

### Run Flat tires

Run Flat tires consist of self-contained tires and special rims. The tire reinforcement ensures that the tire offers some residual safety in the event of pressure drop and driving remains possible to a restricted degree, refer to page 93. The vehicle is equipped with Flat Tire Monitor, refer to page 62.

## TIRE INFLATION PRESSURE

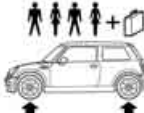
Model	Tires  Pressures specified in psi / kilopascal				
MINI COOPER	175/65 R 15 84 H 175/65 R 15 84 Q M+S	30 / 210	35 / 240		35 / 240 35 / 240
	195/55 R 16 87 H 195/55 R 16 87 H M+S 205/45 R 17 84 V 205/45 R 17 84 V M+S	30 / 210	30 / 210		35 / 240 35 / 240
	175/65 R 15 84 Q M+S 175/60 R 15 82 Q M+S 195/55 R 16 87 Q M+S 205/45 R 17 84 Q M+S	33 / 230	33 / 230		38 / 260 38 / 260
	Space-saver spare tire T 115/70 R 15 90 M	61 / 420	61 / 420		61 / 420 61 / 420
	195/55 R 16 87 V 195/55 R 16 87 V M+S	30 / 210	30 / 210		35 / 240 35 / 240
MINI COOPER S	205/45 R 17 84 V 205/45 R 17 84 Q M+S 205/45 R 17 84 V M+S 195/55 R 16 87 Q M+S	33 / 230	33 / 230		38 / 260 38 / 260
	175/60 R 16 82 Q M+S	36 / 250	36 / 250		41 / 280 41 / 280

All-season tires, M+S, should be inflated to the same pressures as summer tires. Figures as stated here apply to the manufacturer's approved or recommended tires; your MINI Dealer will be happy to provide information on request.

## TIRE CODING

Knowing the tire code on the tire's sidewall makes it easier for you to choose and identify the correct tires.

### Tire size

e.g.

205/45 R 17 84 V

Nominal width in mm

Cross-sectional ratio in %

Radial belt construction

Rim diameter in inches

Load index, not on ZR tires

Speed code letter, in front of the R on ZR tires

Speed code letters:

Q = up to 105 mph / 160 km/h

T = up to 118 mph / 190 km/h

H = up to 131 mph / 210 km/h

V = up to 150 mph / 240 km/h

W = up to 167 mph / 270 km/h

### Tire Identification Number

Tires with DOT codes meet the guidelines of the U.S. Department of Transportation.

DOT code:

e.g.

DOT xxxx xxx 3603

Manufacturer's code for tire make

Tire size and tire version

Tire age

### Tire age

The manufacturer of your MINI recommends replacing all tires, including the space-saver spare tire, regardless of actual wear, after 6 years at the latest.

The date on which the tire was manufactured is indicated by the code on the sidewall:

DOT ... 3603 indicates that the tire was manufactured in Week 36 of the year 2003.

### Uniform Tire Quality Grading

Quality grades can be found where applicable on the tire sidewall between tread shoulder and maximum section width. For example:

### DOT quality grades

Treadwear 200

Traction AA A B C

Temperature A B C



All passenger car tires must conform to Federal Safety Requirements in addition to these grades. ◀

### Tread wear

The tread wear grade is a comparative rating based on the wear rate of the tire when tested under controlled conditions on a specified government test course.

For example, a tire graded 150 would wear one and one-half, 1 ½ times as well on the government course as a tire graded 100. The relative performance of tires depends upon the actual conditions of their use, however, and may depart significantly from the norm due to variations in driving habits, service practices and differences in road characteristics and climate.

## TIRE CODING

### Traction

The traction grades, from highest to lowest, are AA, A, B, and C.

Those grades represent the tire's ability to stop on wet pavement as measured under controlled conditions on specified government test surfaces of asphalt and concrete. A tire marked C may have poor traction performance.

 The traction grade assigned to this tire is based on straight-ahead braking traction tests, and does not include acceleration, cornering, hydroplaning, or peak traction characteristics. ◀

### Temperature

The temperature grades are A, the highest, B and C, representing the tire's resistance to the generation of heat and its ability to dissipate heat when tested under controlled conditions on a specified indoor laboratory test wheel.

Sustained high temperature can cause the material of the tire to degenerate and reduce tire life, and excessive temperature can lead to a sudden flat tire. The grade C corresponds to a level of performance which all passenger car tires must meet under the Federal Motor Vehicle Safety

Standard No. 109. Grades B and A represent higher levels of performance on the laboratory test wheel than the minimum required by law.

 The temperature grade for this tire is established for a tire that is properly inflated and not overloaded. Excessive speed, underinflation, or excessive loading, either separately or in combination, can cause heat buildup and possible tire failure. ◀

### RSC Run Flat tires

You will recognize Run Flat tires by a circular symbol containing the letters RSC on the side of the tire, refer to page 93.

### M+S

Winter and all-season tires. These have better winter performance properties than summer tires.

## TIRE CONDITION

### Tire tread

Inspect your tires frequently for tread wear, signs of damage and for foreign objects lodged in the tread. Check the tread depth.

The tread depth should not fall below 1/8 in / 3 mm.

Below 1/8 in / 3 mm tread pattern depth, there is an increased risk of hydroplaning, even at relatively moderate speeds and with only small amounts of water on the road.

Below a tread depth of 1/6 in / 4 mm, winter tires display a perceptible decrease in their ability to cope with winter driving conditions, and should be replaced in the interest of safety.



Wear indicators in the tread-groove base, arrow, are spread around the circumference of the tire and are marked on the side wall of the tire with TWI, Tread Wear Indicator. The indicators in the tread indicate at 1/16 in / 1.6 mm tread depth that the legally permitted wear limit has been reached.

### Tire damage

 Unusual vibrations while driving can indicate tire damage or other damage to the vehicle. This may be caused, for example, by driving over a curb. This is also true for abnormalities in the vehicle's handling characteristics, such as a pronounced tendency to pull to the left or right. Should this occur, respond by immediately reducing your speed. Proceed carefully to the nearest MINI Dealer or professional tire center, or have the vehicle towed there to have its wheels and/or tires inspected or controlled. Tire damage – up to and including blowouts – can endanger the lives of both the vehicle occupants and other road users. ◀

## WHEEL AND TIRE REPLACEMENT

 Unprofessional attempts by laymen to service tires can lead to damage and accidents.

Have this work performed by skilled professionals only. Your MINI Dealer will be glad to assist you with both their expertise and the proper equipment for your vehicle. ◀

The correct wheel and tire combination also affects various systems that would otherwise be impaired, e.g. ABS or DSC.

Have the wheels balanced after each tire or wheel replacement.

 The manufacturer of your MINI recommends that you avoid using retread tires, as this could impair driving safety. This is due to the possible variations in casing structures and, in some cases, to their extreme age, which can lead to a decrease in their durability. ◀

### The correct wheels and tires

 The manufacturer of your MINI recommends never mounting wheels and tires that have not been specifically approved by the manufacturer for use on your particular model. Although other wheels and tires may theoretically have the same dimensions, variations in factors such

as manufacturing tolerances can result in contact between tire and bodywork, ultimately leading to serious accidents. The manufacturer of your MINI cannot evaluate non-approved wheels and tires to determine if they are suited for use, and therefore cannot ensure the operating safety of the vehicle if they are fitted. ◀

Recommended tire makes:

To maintain good handling and vehicle response, use only tires of a single tread configuration from a single manufacturer. In the event of a flat tire, remount the previous wheel and tire combination as soon as possible.

Run Flat tires:

If your MINI is equipped with Run Flat tires – refer to Run Flat tires – use only these tires, since no space-saver spare tire may be available in the event of a flat.

### Special characteristics of winter tires

The manufacturer of your MINI recommends winter tires for driving in adverse winter road conditions. While all-season tires with the M+S designation provide better winter traction than summer tires, they

generally do not achieve the full performance of winter tires.

For mounting winter tires, refer to the descriptions under Tire condition, page 91, and Wheel and tire replacement.

Run Flat tires:

If your MINI is equipped with Run Flat tires – refer to Run Flat tires – use only these tires, since no space-saver spare tire may be available in the event of a flat.

Observing speeds:

 Never exceed the maximum speed for which the winter tires are rated. Unprofessional attempts by laymen to service tires can lead to damage and accidents. Have this work performed by skilled professionals only. The technicians at your MINI Dealer will be glad to assist you with the required professional knowledge and specialized equipment. ◀

### Storage

Store tires in a cool, dry place, protecting them against light whenever possible. Protect the tires against contact with oil, grease and fuel. Do not exceed the maximum tire inflation pressure specified on the tire sidewall.

## RUN FLAT TIRES\*



You will recognize Run Flat tires by a circular symbol containing the letters RSC on the side of the tire. Run Flat tires consist of self-contained tires and special rims. The tire reinforcement ensures that driving remains possible to a restricted degree in the event of a pressure drop or even a flat tire.

▶ When mounting or replacing summer Run Flat tires with winter tires, or vice versa, use Run Flat tires again since no space-saver spare tire is available in the event of a flat. In this event, the manufacturer of your MINI recommends consulting your MINI Dealer. Your MINI Dealer has the necessary special equipment and expertise for handling Run Flat tires. ◀

### Continuing driving with a damaged tire

Depending on the load, you can continue driving with Run Flat tires at a maximum speed of 50 mph / 80 km/h.

If there is a total loss of tire inflation pressure, 0 psi / 0 kPa, or obvious tire damage, you can gauge the mileage for continued driving on the basis of the following indications:

- ▶ With a light load:
  - 1 to 2 persons without luggage:  
approx. 155 miles / 250 km
- ▶ With a medium load:
  - 2 persons, full cargo area, or  
4 persons without luggage:  
approx. 95 miles / 150 km
- ▶ With a full load:
  - 4 persons or more, full cargo:  
approx. 30 miles / 50 km.

⚠ Drive cautiously. Do not exceed a speed of 50 mph / 80 km/h. In case of tire pressure loss you must expect changes in vehicle handling such as lower track stability during braking, longer braking distances and changes in self-steering properties when close to the handling limit. For safety reasons, the manufacturer of your MINI recommends not having damaged Run Flat tires repaired. In this case, consult your MINI dealer. ◀

### Tire change set

Your MINI is additionally equipped with a tire change set. This is located in the MINI COOPER in the cargo area under the floor mat.

In the MINI COOPER S the tire change set is located in a separate bag which is attached to the eyelets on the cargo area floor by means of tie-down straps.

When changing a tire, always observe the safety measures on page 116, and follow the procedure described on page 117 ff.

▶ In case of a flat tire, the tire change set is not needed, since your MINI has Run Flat tires. ◀

## SNOW CHAINS\*

Only certain types of snow chains have been tested by the manufacturer of your MINI, classified as road-safe and approved. Contact your MINI Dealer for more details. The manufacturer of your MINI recommends that you use only these approved fine-link snow chains. Their use is only permitted in pairs on the front wheels on winter tires of the following types:

- ▷ 175/65 R 15 M+S
- ▷ 175/60 R 16 M+S.

When fitting, comply with the manufacturer's instructions. With chains, do not exceed a speed of 30 mph / 50 km/h.

 Do not initialize the Flat Tire Monitor after attaching snow chains to the tires.

When driving with snow chains, it can be helpful to switch off the ASC or DSC for a brief period, refer to pages [59](#), [60](#). ◀



## BONNET

 Do not attempt to service your vehicle if you do not have the required technical background. Before working in the engine compartment, switch off the engine and allow it to cool down. Before working on the electrical system, always disconnect the battery first. For all work on the vehicle, comply with the appropriate information and instructions. If you are not familiar with the guidelines, the manufacturer of your MINI recommends that you have the service work performed by your MINI Dealer. Otherwise, work improperly carried out on the parts and components can pose a safety hazard for vehicle occupants and other road users. ◀

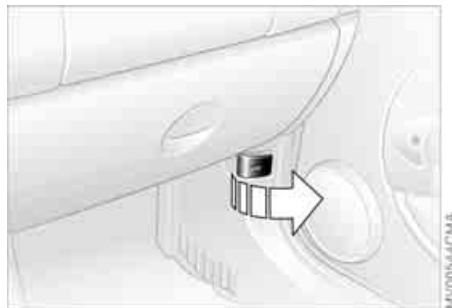

### To unlock

Pull the lever in the right door area beneath the instrument panel.



### To open

1. Reach under the bonnet
2. Pull the release lever
3. Open the bonnet.

### To close

Allow the bonnet to fall from a height of approx. 1 ft / 30 cm.

 To avoid injuries, be sure that the travel path of the bonnet is clear when it is closed, as with all closing procedures. If it is determined that the bonnet is not completely closed while driving, stop immediately and close it securely, also refer to page 16. ◀

## ENGINE COMPARTMENT: MINI COOPER

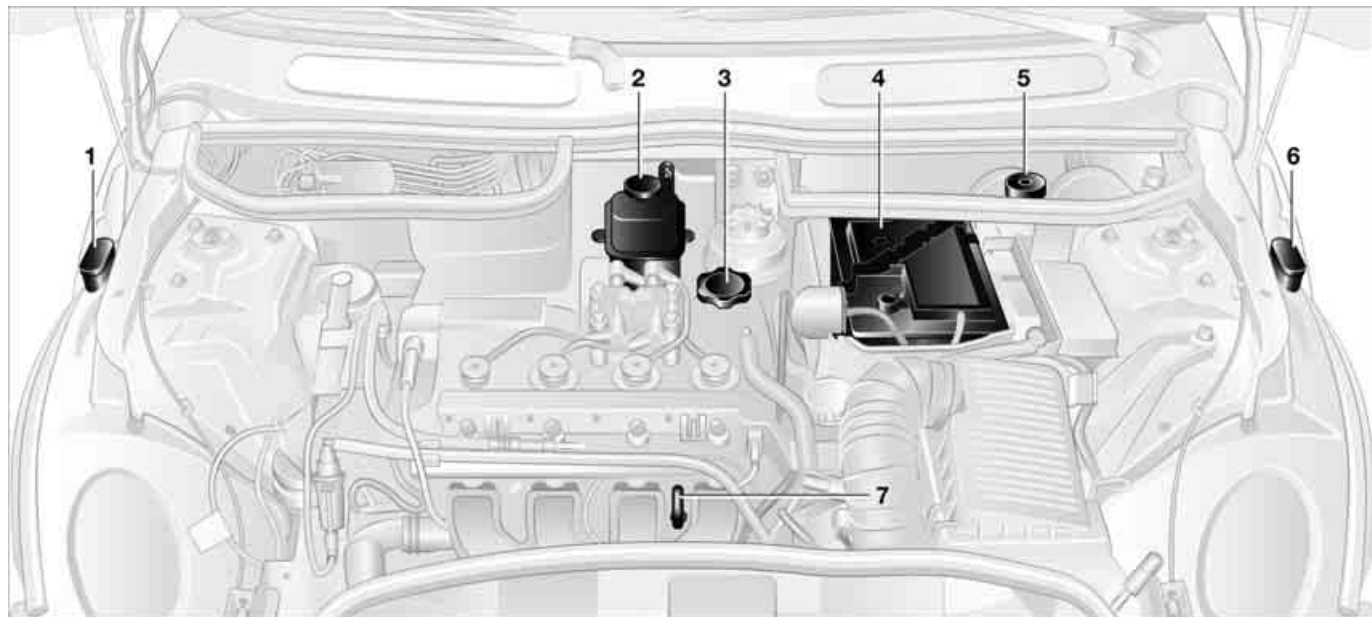

1 Reservoir for windshield washer system 98

2 Coolant expansion tank 100

3 Engine oil filler neck 99

4 Battery 124

5 Brake fluid reservoir 101

6 Reservoir for headlamp cleaning system 98

7 Engine oil dipstick 98

## ENGINE COMPARTMENT: MINI COOPER S

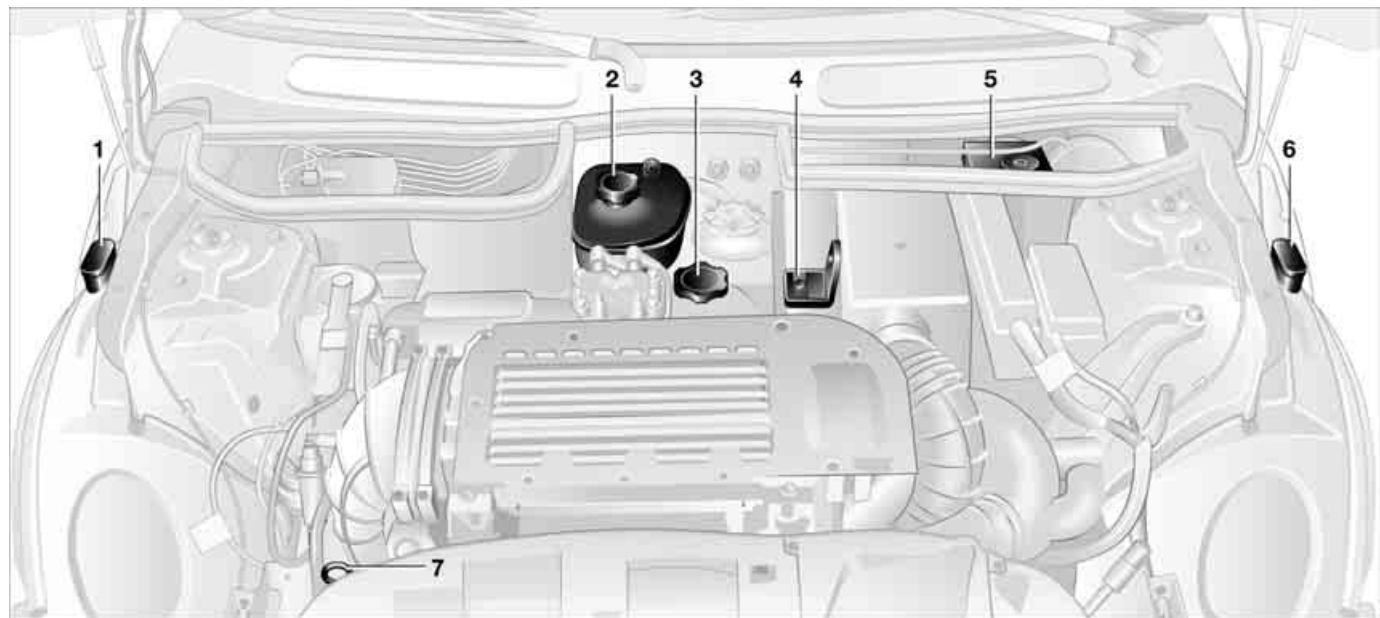

1 Reservoir for windshield washer system 98

2 Coolant expansion tank 100

3 Engine oil filler neck 99

4 Auxiliary terminal for jump-starting 126

5 Brake fluid reservoir 101

6 Reservoir for headlamp cleaning system 98

7 Engine oil dipstick 98

## WASHER FLUID

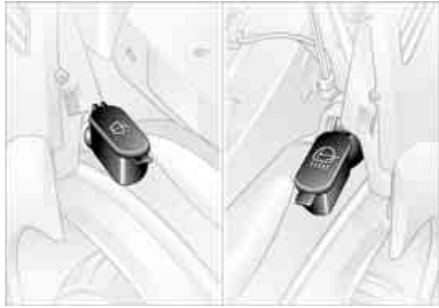

### Headlamp\* and windshield washer system

The capacity of the headlamp washer system is approx. 2.6 quarts / 2.5 liters, that of the windshield washer system approx. 2.1 quarts / 2.0 liters.

Fill with water and, if required, with anti-freeze, according to manufacturer's recommendations.

 We recommend that you mix the washer fluid before adding it to the reservoir. ◀

 Antifreeze agent for the washer systems is flammable. Always keep it well away from sparks and open flames, and store it in tightly closed containers well out of the reach of children. Always observe the instructions for use provided on the container. ◀

## ENGINE OIL

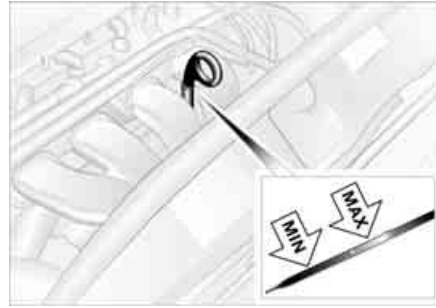

As with fuel economy, oil consumption is directly influenced by your driving style and vehicle operating conditions.

The oil volume between the two notches – MIN, MAX – on the dipstick corresponds to approx. 1.1 quarts / 1 liter. Do not fill beyond the upper notch on the dipstick. Excess oil will damage the engine.

The illustration shows as an example the dipstick of the MINI COOPER.

### Measuring the oil level

1. Park the vehicle on a level surface
2. Switch the engine off after it has reached normal operating temperature
3. Pull the dipstick out after approx. 5 minutes and wipe it off with a lint-free cloth, paper towel, or similar material
4. Carefully push the dipstick all the way into the guide tube and pull it out again. The oil level must be between the two marks on the dipstick.

## ENGINE OIL

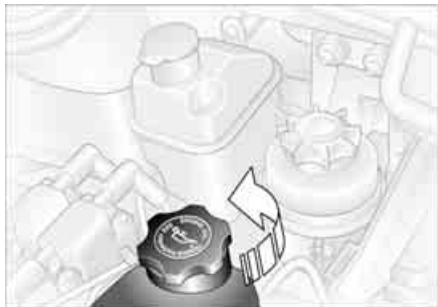

### Adding engine oil

 Only top up oil when the oil level has dropped to just above the lower notch of the dipstick. However, never allow the level to drop below the lower notch. ◀

 MINI engines are designed to operate without oil additives; the use of additives could lead to damage in some cases. That is also valid for the Continuously Variable automatic Transmission (CVT), the gear box and the power assisted steering. ◀

The manufacturer of your MINI recommends that you have the oil changed at your MINI Dealer.

 Continuous exposure to used oil has caused cancer in laboratory testing.

For this reason, any skin areas that come into contact with oil should be thoroughly washed with soap and water.

Always store oil, grease, etc., out of reach of children. Comply with all warning labels and information on lubricant containers. ◀



Comply with the applicable environmental laws regulating the disposal of used oil. ◀

### Specified engine oils

The quality of the engine oil selected has critical significance for the operation and service life of an engine. Based on extensive testing, the manufacturer of your MINI approves only certain grades of engine oil.

Use only approved MINI High Performance Synthetic Oil.

If you are unable to obtain MINI High Performance Synthetic Oil, you can add small amounts of synthetic oil in between oil changes. Only use oils with the API SH specification or higher.

 Ask your authorized MINI Dealer for details concerning the specific MINI High Performance Synthetic Oil or synthetic oils which have been approved. ◀

### Viscosities

Viscosity is the oilflow rating as established in SAE classes.

The choice of the proper SAE class depends on the climatic conditions in the area where your MINI is used.

 Approved oils are in SAE classes 5W-40 and 5W-30. ◀

These oils can be used at all ambient temperatures.

## COOLANT

 Do not add coolant to the cooling system when the engine is hot. Escaping coolant can cause burns.

Antifreeze and anti-corrosion agents are hazardous to health. Always store these agents in tightly-closed original containers kept well away from the reach of children. Antifreeze and anti-corrosion agents are flammable. Therefore, do not spill them over hot engine parts; otherwise they may ignite and cause burns. Always observe the instructions for use provided on the container. ◀

 Comply with the applicable environmental laws regulating the disposal of antifreeze and anti-corrosion agents. ◀

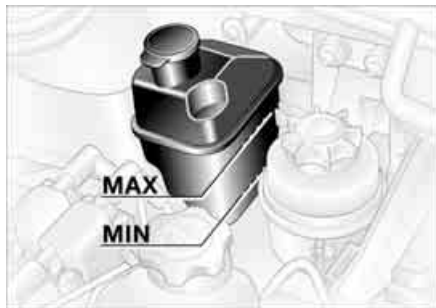

The illustration shows as an example the coolant tank on the MINI COOPER.

### Checking coolant level

Correct coolant level with cold engine, approx. 68 °F / 20 °C:

Up to the MAX mark of the transparent expansion tank.

 Only open the cap of the expansion tank when the engine has cooled down. The needle on the coolant temperature gauge in the display elements must be no higher than in the first quarter; otherwise there is a danger of scalding. ◀

### To add coolant

MINI COOPER:

1. Slowly open the cap by pulling at the tab to allow accumulated pressure to escape
2. Pull open the cap completely
3. If the coolant is low, slowly add coolant until the correct level is reached; do not overfill.

MINI COOPER S:

1. Open the cap by turning it slightly counterclockwise to allow accumulated pressure to escape
2. Unscrew and open the cap completely
3. If the coolant is low, slowly add coolant until the correct level is reached; do not overfill.

The coolant is made up of water and an antifreeze with corrosion resistance. The mixture ratio of 50 to 50 must be kept the entire year due to the required anti-corrosion property. No other additives are required.

Replace the coolant every four years.

## BRAKE FLUID

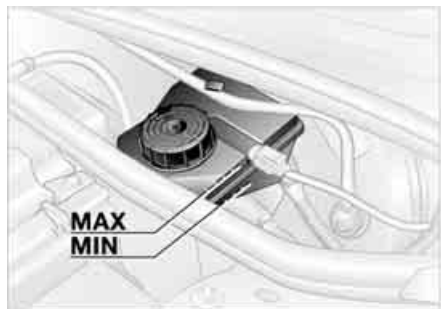

### Warning lamp



If the brake warning lamp comes on with the parking brake released: The brake fluid level is too low, refer to page 15.



Brake warning lamp for Canadian models.

### Adding brake fluid

To add brake fluid or to determine and correct the cause of brake fluid loss, please consult your MINI Dealer. Your MINI Dealer is familiar with the specifications for factory-approved brake fluids, DOT 4.

Brake fluid loss may result in extended brake pedal travel. If this occurs, refer to the information on page 86.



Brake fluid is hygroscopic, that is, it absorbs moisture from the air over time.

In order to ensure the brake system's safety and reliability, have the brake fluid changed every two years by a MINI Dealer, also refer to the Service and Warranty Information Booklet for US models or the Warranty and Service Guide Booklet for Canadian models. Brake fluid is toxic and also damages vehicle paintwork. Always store brake fluid in tightly closed original containers kept well away from the reach of children.

Do not spill the brake fluid and do not fill the brake fluid reservoir beyond the MAX mark. The brake fluid could ignite upon contact with hot engine parts and cause serious burns. ◀



Comply with the applicable environmental laws regulating the disposal of brake fluid. ◀

## MINI MAINTENANCE SYSTEM



The MINI Maintenance System has been designed as a reliable means of providing maximum driving and operating safety, and as cost-effective for you as possible.

Please bear in mind that regular maintenance is not only necessary for the safety of your vehicle, but also plays a significant role in maintaining the resale value of the vehicle.

### Service interval display

While conventional systems specify maintenance according to fixed distances driven, the MINI Maintenance System takes account of the operating conditions of the vehicle, for distances can be driven in many different ways:

60,000 miles / 100,000 km short distance operation can not be equated with 60,000 miles / 100,000 km long distance operation from a maintenance standpoint.

The condition-based MINI Maintenance System includes the Engine Oil Service and Inspections I and II.

Determining the maintenance intervals according to the actual use of the vehicle covers every kind of operating situation. People who drive very little, i.e. much less than 6,000 miles / 10,000 km per year, should have the engine oil changed at least every 2 years since oil deteriorates over time, regardless of use.

For more information on the service interval display, refer to page 56.

### Service and Warranty Information Booklet for US models, Warranty and Service Guide Booklet for Canadian models

For additional information on maintenance intervals and procedures, please refer to the Service and Warranty Information Booklet for US models or the Warranty and Service Guide Booklet for Canadian models.

As a precaution against rust, it is advisable to have the body checked for damage from rocks or gravel at the same time, depending upon operating conditions.

 Have your vehicle's maintenance and repairs performed at your MINI Dealer. Be sure that all maintenance work is confirmed in the Service and Warranty Information Booklet for US models or the Warranty and Service Guide Booklet for Canadian models. These entries are your proof that the vehicle has received regular maintenance. They are also a requirement for warranty claims. ◀



## CARING FOR YOUR VEHICLE

### Suitable car-care products

 Use the cleaning and car-care products available at your MINI Dealer. ◀

### Washing your vehicle

You can wash your new MINI from the outset in automatic car washes. Preference should be for cloth car washes. If, due to lack of availability, brush car washes must be used, modern systems with soft brushes should be given preference.

 When using steam cleaners or high-pressure cleaners, maintain sufficient distance to the vehicle and do not exceed a maximum temperature of 140 °F / 60 °C . If the jet is too close or the pressure is too high, this can lead to damage or initial damage that can develop into more serious damage. Water that enters vehicle components can lead to damage over the long term. ◀

 After washing the vehicle, apply the brakes briefly to dry them, otherwise water can reduce braking efficiency over the short term and the brake rotors can corrode. ◀

 Switch the rain sensor off when passing through an automatic car wash, refer to page 50. Failure to do so could result in damage caused by undesired wiper activation. ◀

### Rod antenna

 If necessary, for example before entering a car wash or a garage with elevator ramp, remove the rod antenna. To do so, grip the rod antenna at the base and unscrew it from the antenna foot by turning it to the left. ◀

### Headlamps

 When cleaning the headlamps, please observe the following: do not rub them dry, and never use abrasives or strong solvents. Remove dirt and contamination, such as insects, by soaking with shampoo and then rinsing with plenty of water. Always use a deicer spray to remove accumulated ice and snow; never use a scraper. ◀

### Vehicle paintwork

Regular care contributes greatly to driving safety and value retention.

Environmental influences varying from one region to the next can affect the vehicle paintwork. Please base the frequency and scope of car care on these various influences.

### Care of upholstery

Depressions that come about on the upholstery material of the seats in daily use can be brushed out using a slightly damp brush against the grain.

The fact that velour lays down is not a quality defect, but rather is inevitable in the case of home textiles or clothing materials.

In the case of strong sunlight and longer parking periods, cover the seats or all windows to prevent discoloration.

## CARING FOR YOUR VEHICLE

### Care of special parts

#### ▷ Light-alloy wheels\*:

Use wheel cleaner especially during the winter months, but do not use any aggressive, acidic, strong alkali or rough cleansers or steam jets above 140 °F / 60 °C . Observe the manufacturer's instructions

#### ▷ Chrome parts\* such as bonnet grill, door handles, etc.:

Especially if exposed to road salt, carefully clean these parts with plenty of water and possibly with a shampoo additive.

For additional treatment, use chrome polish

#### ▷ Rubber parts:

Treat only with water or rubber care products



Do not use silicon sprays or other silicon-containing care products, otherwise noise and damage could occur. ◀

#### ▷ Plastic parts, imitation leather surfaces, headliner, lamp glass, covering glass for the display elements, as well as matt black molded parts:

Clean with water and, if necessary, plastic care products. Do not dampen seats and the headliner.

Never use solvents such as lacquer thinner, heavy-duty grease remover, fuel or similar

#### ▷ Wood paneling\*:

Please clean wood paneling and other wood parts only with a damp cloth. Dry off with a soft cloth

#### ▷ Safety belts:

Only clean using mild soap, leaving the belts fitted.

Do not dry clean, as the fabric can be destroyed.

Always roll up safety belts only when dry. Dirty safety belts prevent unrolling and thus negatively affect safety

#### ▷ Floor carpets and floor mats\*:

If heavily soiled, clean using interior cleaner. Floor mats can be removed to allow the interior to be cleaned

#### ▷ Wiper blades:

Clean with soapy water. Replace wiper blades twice a year, before and after the cold season. This is particularly important on vehicles fitted with a rain sensor.

## CARING FOR YOUR VEHICLE

### Caring for leather\* and imitation leather

The leather and imitation leather used by the manufacturer of your MINI are high quality products processed using state-of-the-art methods and will retain their quality level for many years if cared for properly.

Regular cleaning and care are necessary, as dust and road dirt scratch in pores and creases and lead to heavy wear as well as premature brittleness of the leather and imitation leather surface.

This is why you should use a cloth or vacuum cleaner to remove dust on a regular basis.

Since dirt and oil slowly destroy the protective layer of the leather and imitation leather, a treatment with a leather care product is necessary twice a year. This preserves the quality of the leather and prevents electrostatic charging.



Cleaning agents can contain hazardous or health-damaging substances. For this reason, always observe the warnings on the package. For interior cleaning, always open the doors or windows of the vehicle.

Do not use any products that are not intended for cleaning the vehicle. ◀

## VEHICLE STORAGE

Your MINI Dealer will be glad to advise you on what is important if the vehicle is to be decommissioned for longer than three months.

## OBD SOCKET



The Onboard Diagnostic OBD interface socket is located on the left of the driver's side under the instrument panel and under a cover.

The cover has the letters OBD on it.

The purpose of the OBD system is to ensure proper operation of the emission control system for the vehicle's lifetime. The system monitors emission-related components for deterioration and malfunction.



An illuminated lamp informs you of the need for service, not of the need to stop the vehicle.

However, the system should be checked by your MINI Dealer at the earliest possible opportunity.



Indicator lamp for Canadian models.

Under certain conditions, the indicator will blink or flash. This indicates a rather severe level of engine misfire. When this occurs, you should reduce speed and consult the nearest MINI Dealer as soon as possible. Severe engine misfire over only a short period of time can seriously damage emission control components, especially the catalytic converter.



When the gas cap is not properly tightened, the OBD system can detect the vapor leak and the indicator will light up. If the cap is subsequently tightened, the indicator lamp should go out within a few days. ◀

## CALIFORNIA PROPOSITION 65 WARNING

California laws require us to state the following warning:



Engine exhaust and a wide variety of automobile components and parts, including components found in the interior furnishings in a vehicle, contain or emit chemicals known to the State of California to cause cancer and birth defects and reproductive harm.

In addition, certain fluids contained in vehicles and certain products of component wear contain or emit chemicals known to the State of California to cause cancer and birth defects or other reproductive harm.

Battery posts, terminals and related accessories contain lead and lead compounds.

Wash your hands after handling. Used engine oil contains chemicals that have caused cancer in laboratory animals.

Always protect your skin by washing thoroughly with soap and water. ◀



OVERVIEW

OVERVIEW

CONTROLS

CONTROLS

OPERATION, CARE, MAINTENANCE

OPERATION

**OWNER SERVICE PROCEDURES**

**REPAIRS**

TECHNICAL DATA

DATA

INDEX

INDEX

## ONBOARD TOOL KIT



The picture shows as an example the tire change set with onboard tools for vehicles with the space-saver spare tire.

Depending on the level of equipment options, your MINI is fitted with a special onboard tool kit stored at the locations described below:

### Storage location

MINI Mobility System with tire change set and onboard tools:

▷ In the cargo area under the floor mat.

Tire change set and onboard tools for Run Flat tires:

▷ Tire change set:

In the cargo area in a separate pouch, refer to page [123](#)

▷ Onboard tool kit:

on the left-hand side of the cargo area behind the side trim panel.

Tire change set with space-saver spare tire:

▷ In the cargo area under the floor mat.

## WINDSHIELD WIPER BLADES

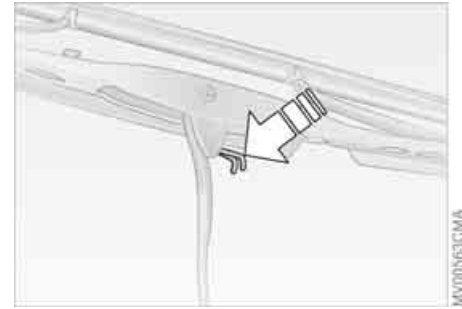

### Windshield wiper

1. Rotate the wiper arm completely out from the windshield
2. Set the wiper blade at an angle
3. Press the securing spring, arrow
4. Unhook the wiper blade towards the windshield
5. Pull the wiper blade past the wiper arm toward the top
6. Insert the new wiper blade
7. Press into position until you hear it engage.



## WIPER BLADES

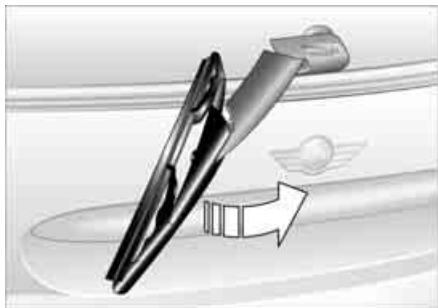

### Rear window wiper

1. Rotate the wiper arm completely out from the windshield
2. Turn the wiper blade as far as it will go to the rear, see arrow
3. Press the wiper blade against the limit and thus out of the mounting
4. Press the new wiper blade into the mounting.

## LAMPS AND BULBS

Lamps and bulbs are an important component of vehicle safety. Therefore, proceed carefully when handling bulbs. The manufacturer of your MINI recommends that you have such work performed by your MINI Dealer if you are not familiar with the procedures.

 Do not touch the glass portion of a new bulb with your bare hands since even small amounts of impurities burn into the surface and reduce the service life of the bulb. Use a clean cloth, paper napkin, or similar material, or hold the bulb by its metallic base. ◀

A replacement bulb set is available at your MINI Dealer.



Whenever working on the electrical system, switch off the electrical accessory you are working on or disconnect the cable from the negative terminal of the battery. Failure to do this could result in short circuits.

To prevent injuries and damage, comply with any instructions provided by the bulb manufacturer. ◀

## LAMPS AND BULBS

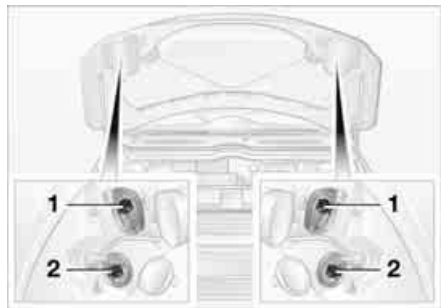

### 1 Low beams

H7 bulb, 55 Watts

### 2 High beams

H7 bulb, 55 Watts

 The H7 bulb is pressurized. Therefore, wear safety glasses and protective gloves. If the lamp is damaged there is a risk of injury. ◀

### Replacing bulbs

The headlamps are integrated into the MINI engine compartment.

1. Pull on the tab of the cover of the defective lamp and open it
2. Press the retaining wire lightly at the eyelet and at the same time guide it outwards
3. Fold the retaining wire down
4. Remove the lamp holder and replace the lamp
5. Reinsert the lamp holder in the correct position
6. Fold the retaining wire back up and catch in place.

Ensure that it is placed in the middle of the wire connector.

### Xenon lamps\*

The service life of these bulbs is very long and the probability of a failure is very low, provided that they are not switched on and off an unusual number of times. If one of these bulbs should nevertheless fail, it is possible to continue driving with great caution using the fog lamps, provided traffic laws in your area do not prohibit this.

 Because of the extremely high voltages involved, any work on the xenon lighting system should be carried out by technically qualified personnel only. Otherwise, there is a risk of fatal injury. ◀



### Turn signal indicators, front

21 Watt bulb

1. Open the bonnet
2. Reach into the opening for the turn signal indicators from above
3. Apply gentle pressure to the bulb holder while turning it to the left
4. Remove and replace the bulb.

### Parking lamps and standing lamps

5 Watt bulb

The parking lamps and standing lamps are integrated in the lamp housing of the turn signal indicator.

1. Turn the bulb holder to the left and pull out
2. Remove and replace the bulb.

## LAMPS AND BULBS



### Side turn signal indicators

5 Watt bulb

1. Press lamp toward vehicle tailgate and remove
2. Remove and replace the bulb.

### Side marker lamps

3 Watt bulb

Side marker lamps in the wheelhouse paneling of the bumper.

Please contact a MINI Dealer in case of a malfunction.



### Fog lamps\*

H11 bulb, 55 Watts

Please contact a MINI Dealer in case of a malfunction.

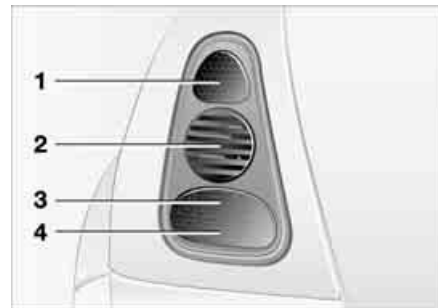

### Tail lamps

Rear lamp 3: bulb 21/5 Watts

Other bulbs: 21 Watts

- |                         |        |
|-------------------------|--------|
| 1 Rear fog lamp*        | red    |
| 2 Turn signal indicator | yellow |
| 3 Rear lamp             | red    |
| 4 Rear lamp/Brake lamp  | red    |

## LAMPS AND BULBS

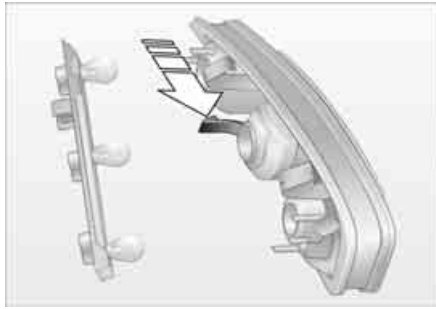

To make this clear, the illustration shows a dismantled tail lamp with the bulb holder removed. All of the bulbs are integrated in the bulb holder.

To reach the bulb holder, remove the cover of the side trim panel in the cargo area.

### Replacing bulbs

1. Unplug the power supply
2. Release the bulb holder, arrow, and remove
3. Apply gentle pressure to the bulb while turning it to the left
4. Remove and replace the bulb
5. Plug in the power supply receptacle
6. Press the bulb holder into position until you hear it engage.



### Backup lamp

With the space-saver spare tire option:

Access to the lamp via the back or underside of the bumper.

1. Press the clips together
2. Push the lamp out of the bumper
3. Apply gentle pressure to the bulb while turning it to the left
4. Remove and replace the bulb.

Other equipment:

Please contact a MINI Dealer in case of a malfunction.



### Center high-mount brake lamp

LED strip on the tailgate.

Please contact a MINI Dealer in case of a malfunction.

## LAMPS AND BULBS

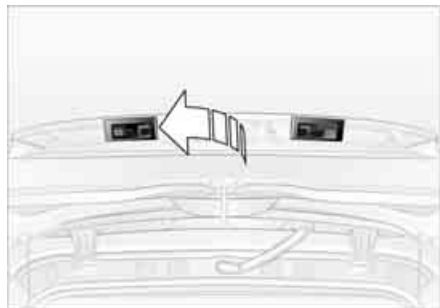

### License plate lamps

5 Watt bulb

1. Apply a screwdriver to the recess and lever out the lamp cover
2. Replace the bulb.



### Interior lamps

6 Watt xenon bulb

1. Press out the lamp cover with a screwdriver
2. Remove and replace the bulb.

### Reading lamps

2 x 6 Watt xenon bulbs

1. Press out the lamp cover with a screwdriver
2. Unscrew the entire lamp with a screwdriver
3. Remove the bulb from above and replace.

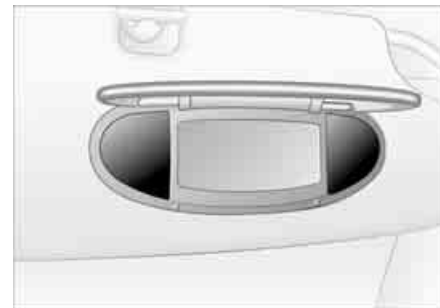

### Illuminated vanity mirror

Lamps in the vanity mirror in the sun visor.

Please contact a MINI Dealer in case of a malfunction.

## LAMPS AND BULBS



### Footwell lamps

5 Watt bulb

1. Press out the lamp cover with a screwdriver
2. Remove and replace the bulb.

### Glove compartment lamp

5 Watt bulb

1. Press out the lamp cover with a screwdriver
2. Remove and replace the bulb.

### Cargo area lamps

5 Watt bulb

1. Press the lamp cover to the left and out with a screwdriver.
2. Remove and replace the bulb.

## REPAIRING A FLAT TIRE



Safety measures in the event of a flat tire:

Stop the vehicle as far as possible from passing traffic. Switch on the hazard warning flashers.

Turn the steering wheel to the straight-ahead wheel position and engage the steering lock. Engage the parking brake and shift into 1st or reverse gear – selector lever in P.

All passengers should be outside the vehicle and well away from your immediate working area – behind a guardrail, for instance.

If a portable hazard warning lamp is available, set it up on the roadside at an appropriate distance from the rear of the vehicle. Comply with all safety guidelines and regulations. ◀

In the event of a flat tire, different procedures should be followed depending on the equipment included in your MINI:

- ▷ Vehicles with Run Flat tires, refer to page [93](#)
- ▷ Vehicles with a space-saver spare tire, refer to the following section
- ▷ Vehicles with MINI Mobility System, refer to page [121](#).

## CHANGING TIRES: MINI WITH SPACE-SAVER SPARE TIRE\*

 Additional safety measures in the event of a wheel change:

Change the wheel only on a level, firm surface which is not slippery.

The vehicle or the jack could slip sideways on soft or slippery support surfaces, such as snow, ice, flagstones, etc..

Do not use a wooden block or similar object as a support base for the jack, as this would prevent it from extending to its full support height and reduce its load-carrying capacity.

Do not lie under the vehicle or start the engine when the vehicle is supported by the jack – risk of fatal injury. ◀

To change a space-saver tire, proceed as follows:

- ▷ Remove space-saver spare tire, refer to the section after the next one
- ▷ Prepare for tire change, refer to page 119
- ▷ Jack up the vehicle, refer to page 119
- ▷ Fit the space-saver spare tire, refer to page 120
- ▷ Tighten the lug bolts, refer to page 120
- ▷ Drive with space-saver spare tire, refer to page 120.



### Tire change set

On vehicles with a space-saver spare tire, the tire change set is stored in the cargo area under the floor mat.

- 1 Chock, folding
- 2 Hubcap remover
- 3 Wheel stud wrench
- 4 Jack
- 5 Lug wrench
- 6 Towing eyelet
- 7 Lifting handle

The onboard tool kit includes a pouch with a plastic bag in which you can place the damaged wheel.



### Removing the space-saver spare tire

The screw connection of the space-saver spare tire is in the cargo area under the floor mat, on the base of the storage compartment for the tire change set.

1. Loosen the screw connection using the wheel lug bolt wrench
2. Take out the cover panel

## CHANGING TIRES: MINI WITH SPACE-SAVER SPARE TIRE\*

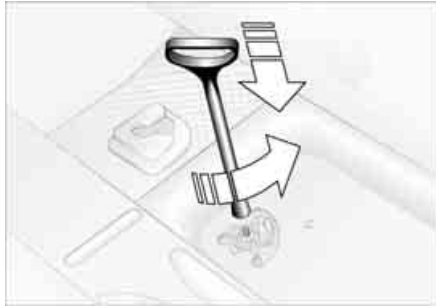

3. Screw the lifting handle from the onboard tool kit onto the thread
4. Raise the lifting handle slightly



5. Squeeze the securing springs
6. The space-saver spare tire is released and must be held by the lifting handle
7. Lower the space-saver spare tire with the lifting handle
8. Unscrew the lifting handle again



9. Pull out the space-saver spare tire towards the rear underneath the vehicle
10. Position the space-saver spare tire with the valve facing upwards
11. Unscrew the valve extension from the valve of the space-saver spare tire
12. Unscrew the dust cap from the extension and attach to the valve on the spare tire.

 Due to its different dimensions, the damaged wheel cannot be placed in the recess for the space-saver spare tire. ◀



## CHANGING TIRES: MINI WITH SPACE-SAVER SPARE TIRE\*

### Preparing for a tire change

 Follow the safety precautions on pages 116 and 117. ◀

1. Secure the vehicle to prevent it from rolling:

Place the folding chock behind the front wheel on the other side of the vehicle; on downward inclines, place it in front of this wheel.

If the wheel is changed on a surface with a more severe slope, take additional precautions to secure the vehicle from rolling

2. Loosen the lug bolts by a half turn.

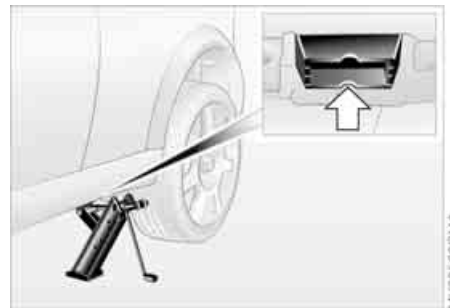
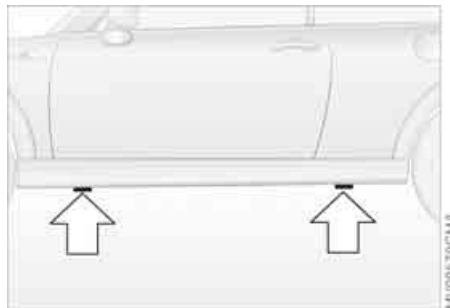

### Jacking up the vehicle

1. Place the jack at the jacking point closest to the wheel.

The jack base must be perpendicular to the surface beneath the jacking point



The vehicle jack is designed for changing wheels only. Do not attempt to raise another vehicle model with it or to raise any load of any kind. To do so could cause accidents and personal injury. ◀

2. During jacking up, insert the jack head in the square recess of the jacking point
3. Jack the vehicle up until the wheel you are changing is raised from the ground.

## CHANGING TIRES: MINI WITH SPACE-SAVER SPARE TIRE\*

### Fitting the space-saver spare tire

1. Unscrew the lug bolts and remove the wheel
2. Remove accumulations of mud or dirt from the mounting surfaces of the wheel and hub. Clean the lug bolts
3. Fit the space-saver spare tire
4. Screw at least two lug bolts finger-tight into opposite bolt holes
5. Screw in the remaining bolts
6. Tighten all the lug bolts firmly in a diagonal pattern
7. Lower the vehicle
8. Remove the jack.

### Tightening the lug bolts

Tighten the lug bolts in a diagonal pattern.

 As soon as possible, have the secure seating of the lug bolts, tightening torque 88.5 lb ft / 120 Nm, checked using a calibrated torque wrench. Otherwise, a wheel coming loose can lead to a severe accident. ◀

Replace the defective tire as soon as possible and have the new wheel/tire assembly balanced.

### Driving with the space-saver spare tire

Drive cautiously. Do not exceed a speed of 50 mph / 80 km/h.

You must expect changes in vehicle handling such as lower track stability during braking, longer braking distances and changes in self-steering properties when close to the handling limit. These effects are more pronounced when driving with winter tires.



Only one space-saver spare tire may be mounted at one time. Reinstall a wheel and tire of the original size as soon as possible. ◀



Check the tire inflation pressure at the earliest opportunity and correct it if necessary. ◀

# MINI MOBILITY SYSTEM\*

## MINI Mobility System

To repair a flat tire you will find a MINI Mobility System in your MINI. With the help of this system you can apply a liquid sealant on the inside of the tire, which seals the damaged area and enables you to continue to drive.

## Preparing for tire repair

 Before using the MINI Mobility System read the warning and danger precautions on the equipment. ◀

If possible, leave objects in which have been forced into the tire.

Take off the tag regarding speed limits and stick it onto the steering wheel.

## Using the MINI Mobility System

In order to repair a flat tire with the MINI Mobility System, proceed as follows:

- ▷ Pump in liquid sealant, refer to page [122](#)
- ▷ Reinflate the tire, refer to page [122](#)
- ▷ Distribute liquid sealant, refer to page [123](#)
- ▷ Check tire inflation pressure, refer to page [123](#)
- ▷ Drive on, refer to page [123](#).

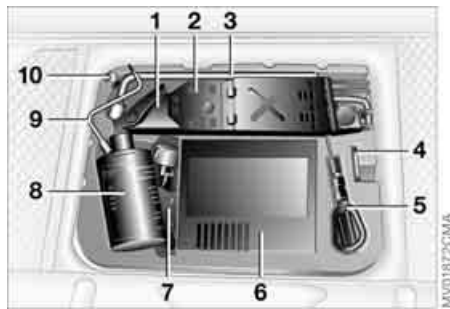

## MINI Mobility System with onboard tools

The MINI Mobility System with tire change set and onboard tools is located in the cargo area under the floor mat:

- 1 Jack
- 2 Chock, folding
- 3 Wheel stud wrench
- 4 Hubcap remover
- 5 Wrench, screwdriver/Phillips screwdriver, towing eyelet
- 6 Compressor, hose with manometer and plug for cigarette lighter socket
- 7 Package with filling hose, valve remover and valve core
- 8 Filling canister
- 9 Hex wrench/screwdriver
- 10 Adapter for wheel lug lock

## MINI MOBILITY SYSTEM\*





### Pumping in liquid sealant

1. Shake the filling canister
2. Screw the filling hose onto the filling canister
3. Unscrew the dust protection cap from the valve of the defective tire
4. Screw out the valve core with the valve remover. The valve remover is located in a package with the filling hose

 Place the valve core and valve remover only on clean surfaces.◀

5. Remove the cap from the filling hose
6. Push the filling hose onto the tire valve
7. Hold the filling canister with the cap down and squeeze.  
Squeeze the entire contents of the canister into the tire
8. Remove filling hose
9. Screw valve core into the tire valve with the valve remover.

 In the event of a lost or dirty valve core you will find another valve core in a package with the filling hose.◀

 Please remember that the liquid canister must be replaced every four years if the equipment has not been used.◀

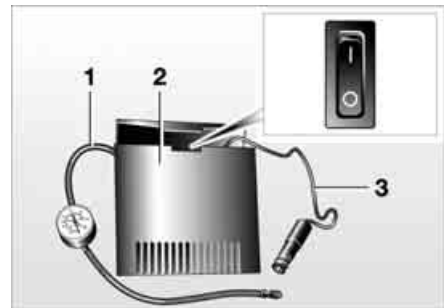

### Reinflating the tire

1. Screw hose 1 with manometer onto the tire valve
2. Connect plug 3 to the cigarette lighter socket in the vehicle interior, refer to page 74
3. Ignition key in position 1:  
Turn on compressor 2
4. Inflate the tires to at least 26 psi / 180 kPa, but not to more than 36 psi / 250 kPa.

To check the current air pressure, shut off the device for a short time

 Do not run the compressor for longer than 6 minutes, otherwise the device will overheat and possibly be damaged.◀

## MINI MOBILITY SYSTEM\*

 If an air pressure of 26 psi / 180 kPa cannot be reached, unscrew the hose 1 and drive back and forth about 33 ft / 10 m so that the liquid sealant is distributed in the tire. Afterwards repeat the procedure. If an air pressure of 26 psi / 180 kPa is still not reached, the tire is too badly damaged. Please contact the nearest MINI Dealer. ◀

5. Turn off compressor 2
6. Unscrew hose 1 from the tire valve
7. Store the MINI Mobility System back in the vehicle.

 The instructions for using the MINI Mobility System are also given on the equipment. ◀

### Distributing liquid sealant

Immediately drive for approx. 10 minutes, so that the liquid sealant is uniformly distributed.

 Do not exceed a speed of 40 mph / 60 km/h.  
If possible do not drive at a speed lower than 10 mph / 20 km/h. ◀

### Checking tire inflation pressure

1. After driving for approx. 10 minutes, pull over at a suitable location
2. Screw hose with manometer back onto the tire valve
3. Check tire pressure

 The tire inflation pressure must be at least 18 psi / 130 kPa betragen. If it is not, do not continue driving. ◀

If 18 psi / 130 kPa are displayed:

4. Ignition key position 1:  
Turn on compressor 2. Correct the tire inflation pressure to the specified value, refer to the tire inflation pressure table on page 88
5. Replace the tire as soon as possible.

 The use of the MINI Mobility System may be ineffective with tire damage larger than approx. 1/6 in / 4 mm. Please contact the nearest MINI Dealer if the tire cannot be made drivable with the MINI Mobility System. ◀

### Driving on

 Do not exceed the permitted maximum speed of 50 mph / 80 km/h; otherwise an accident could happen. ◀

 Replace the defective tire as soon as possible and have the new wheel/tire assembly balanced.  
Have the MINI Mobility System refilled. Please contact your MINI Dealer. ◀

### Tire change set

Your MINI is additionally equipped with a tire change set. This is located in the MINI COOPER in the cargo area under the floor mat.

When changing a tire, always observe the safety measures on page 116, and follow the procedure described on page 119 ff.

 In case of a flat tire the tire change set is not necessary due to the availability of the MINI Mobility System. ◀

## BATTERY

### Location in the MINI COOPER

The battery is located in the engine compartment.

Exact location, refer to page 96.

### Location in the MINI COOPER S

The battery is located in the cargo area under the floor mat.

### Battery care

The battery is absolutely maintenance-free, that is, the original electrolyte will normally last for the service life of the battery under moderate climatic conditions.



For all questions regarding the battery, please consult your MINI Dealer. ◀

### Charging the battery

Only charge the battery in the vehicle via the terminals in the engine compartment with the engine switched off, refer to 'Jump-starting', page 126 ff.

### Disposal



Return used batteries to a recycling point or your MINI Dealer. Maintain the battery in an upright position for transport and storage. Secure the battery to prevent it from tilting during transport. ◀

## FUSES



 Do not attempt to repair a blown fuse or replace it with a fuse of a different color or Ampere rating. To do this could cause a fire in the vehicle resulting from a circuit overload. ◀

 If a fuse blows a second time, have the cause of the damage rectified by your MINI Dealer. ◀

A fuse allocation diagram is located on the inside of the fuse box cover panel.

Plastic tweezers can be found in the fuse box in the vehicle interior, refer to next column.

### In the engine compartment

In the MINI COOPER to the right of the battery.

In the MINI COOPER S to the right of the air filter box.

Open the fuse box lid. To do so, press the clip fastener.

### In the vehicle interior

On the left side of the footwell in the side trim panel.

Open the cover panel of the fuse box. To do so, press the fastener.

## JUMP-STARTING

When your battery is discharged, you can use two jumper cables to start your MINI with power from the battery in a second vehicle. Correspondingly you can help start another vehicle. Only use jumper cables with fully insulated handles on the terminal clamps.

### Preparing for jump-starting



Do not touch live wiring and cables on a running engine. There is a risk of fatal injury if you do this. Carefully observe the following instructions to avoid personal injury and/or damage to either vehicle or both vehicles. Make sure that there is no contact between the bodywork of the two vehicles to avoid a short circuit hazard. ◀

1. Check whether the battery of the support vehicle has 12 Volts and approximately the same capacity measured in Ah. These data are printed on the battery
2. Switch off the engine of the support vehicle
3. Switch off any electrical systems and components in both vehicles.

### Connect the jumper cables



Always adhere to this sequence when connecting the jumper cables; failure to observe this procedure can lead to sparking and pose an injury hazard. ◀



## JUMP-STARTING

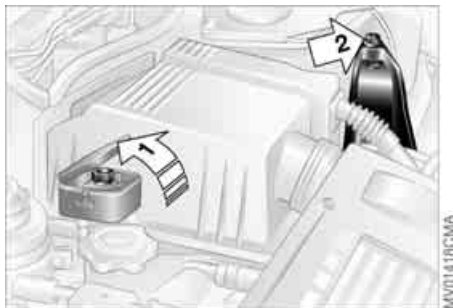

The illustration shows the auxiliary jump-starting terminal on the MINI COOPER S. In the MINI COOPER S, the auxiliary jump-starting terminal, arrow 1, acts as the positive battery terminal, refer to view of engine compartment on page 97.

1. Remove the cover of the battery or open the cover of the auxiliary jump-starting terminal:
    - ▷ MINI COOPER:  
Remove the battery cover.  
To do so, press the two clips simultaneously.
    - ▷ MINI COOPER S:  
Open the cover of the auxiliary jump-starting terminal, arrow 1
  2. Connect one terminal clamp of the plus/+ jumper cable to the positive battery terminal or to an auxiliary jump-starting terminal of the support vehicle
  3. Connect the other terminal clamp of the plus/+ jumper cable to the positive battery terminal or to an auxiliary jump-starting terminal of the vehicle to be started
- Engine or body ground in your MINI:  
arrow 2.
4. Connect one terminal clamp of the minus/- jumper cable to the negative battery terminal or to an engine or body ground of the support vehicle
  5. Connect the second terminal clamp of the minus/- jumper cable to the negative terminal of the battery or to the engine or body ground of the vehicle to be started.

### Performing the jump-start

1. Start the engine of the support vehicle and allow it to run at a fast idle speed for several minutes
2. Start the engine of the other vehicle in the usual manner.  
If the first start attempt is not successful, wait a few minutes before another attempt in order to allow the discharged battery to recharge
3. Allow the engines of both vehicles to run for several minutes



On the MINI: before disconnecting the jumper cables, switch on the lighting, the rear window defroster and the highest blower speed to prevent a voltage surge from the regulator to the electrical systems and components. ◀

4. Then disconnect the jumper cables in the reverse order.

If necessary have the battery checked and completely charged at a MINI Dealer.



Do not use spray starter fluids to start the engine. ◀

## TOWING

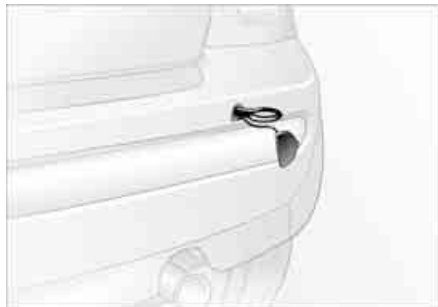

For towing, use either a tow bar or nylon ropes or straps that prevent sudden jerking movements.

### Towing eyelet

The screw-in towing eyelet is stored in the onboard tool kit; be sure that it remains in the vehicle at all times. It can be attached at the front or rear of the vehicle.

### Access to tow sockets

Use a suitable object, e.g. credit card, screwdriver, to press out the covers from the recess.

 Use only the towing eyelet supplied with the vehicle and screw it in firmly until it stops. Use the towing eyelet for towing on paved roads only. If you do not follow these instructions, the towing eyelet could detach itself from the vehicle or the vehicle could be damaged. Never attach tie-down hooks, chains, straps, or tow hooks to tie rods, control arms, or any other part of the vehicle suspension, as this could damage the components and possibly lead to accidents. ◀

 Avoid staggered towing and make sure that the towing rope is taut before the vehicle that is towing drives off. ◀

### Tow bars

If the towing eyelets of the two vehicles are not directly opposite one another, please note:

- ▷ Clearance and maneuvering capability will be strictly limited in corners
- ▷ The inclination of the tow bar generates lateral force, critical above all if the road surface is slippery.

 Do not tow a vehicle that is heavier than the towing vehicle; otherwise it will no longer be possible to control the vehicle's response. ◀

## TOWING

### Tow-starting

It is not possible to start the engine of a vehicle equipped with an automatic transmission by towing or pushing.

For instructions on jump starting, refer to page 126.

Never attempt to use your vehicle to push another car, since damage to the energy-absorbing bumpers could result.

### Towing a vehicle

 Only tow vehicles with Continuously Variable automatic Transmission (CVT) with the front wheels raised or on a special transport vehicle, otherwise the transmission can be damaged. ◀

1. Place gear selector lever in neutral or idle
2. Towing speed:  
Max. 45 mph / 70 km/h
3. Towing distance:  
Max. 95 miles / 150 km
4. Leave the ignition key at position 1 to ensure that the brake lamps, turn signals, horn and windshield wipers remain operative, and to prevent the steering lock detent from engaging
5. Switch on the hazard-warning system, observe country-specific regulations.

Find some means of identifying the vehicle in tow, for instance, by turning on the hazard warning flashers.

 Make sure that the ignition key remains in position 1 even when the electrical system has failed to prevent the steering lock from engaging. The steering and brakes are without power assist when the engine is off. This means that increased effort is required for steering and braking. ◀

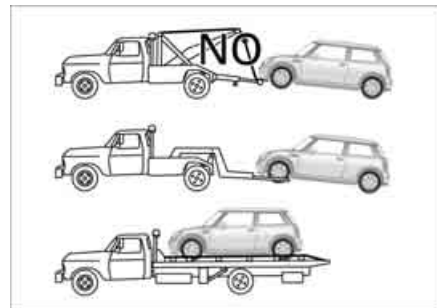

### Towing with a commercial tow truck

- ▷ Do not tow with sling-type equipment
- ▷ Use a wheel-lift or flatbed carrier
- ▷ Please comply with applicable towing laws.

 Never allow passengers to ride in a towed vehicle for any reason. ◀



OVERVIEW

OVERVIEW

CONTROLS

CONTROLS

OPERATION, CARE, MAINTENANCE

OPERATION

OWNER SERVICE PROCEDURES

REPAIRS

TECHNICAL DATA

DATA

INDEX

INDEX

## ENGINE DATA

		MINI COOPER	MINI COOPER S
Displacement	cu in / cm <sup>3</sup>	97.52 / 1,598	97.52 / 1,598
Number of cylinders		4	4
Maximum output at engine speed	hp / kW rpm	115 / 85 6,000	163 / 120 6,000
Maximum torque at engine speed	lb ft / Nm rpm	110 / 149 4,500	155 / 210 4,000
Compression ratio	$\epsilon$	10.6	8.3
Stroke	in / mm	3.38 / 85.8	3.38 / 85.8
Bore	in / mm	3.03 / 77	3.03 / 77
Fuel mixture preparation		Digital electronic engine-management system	

## DIMENSIONS

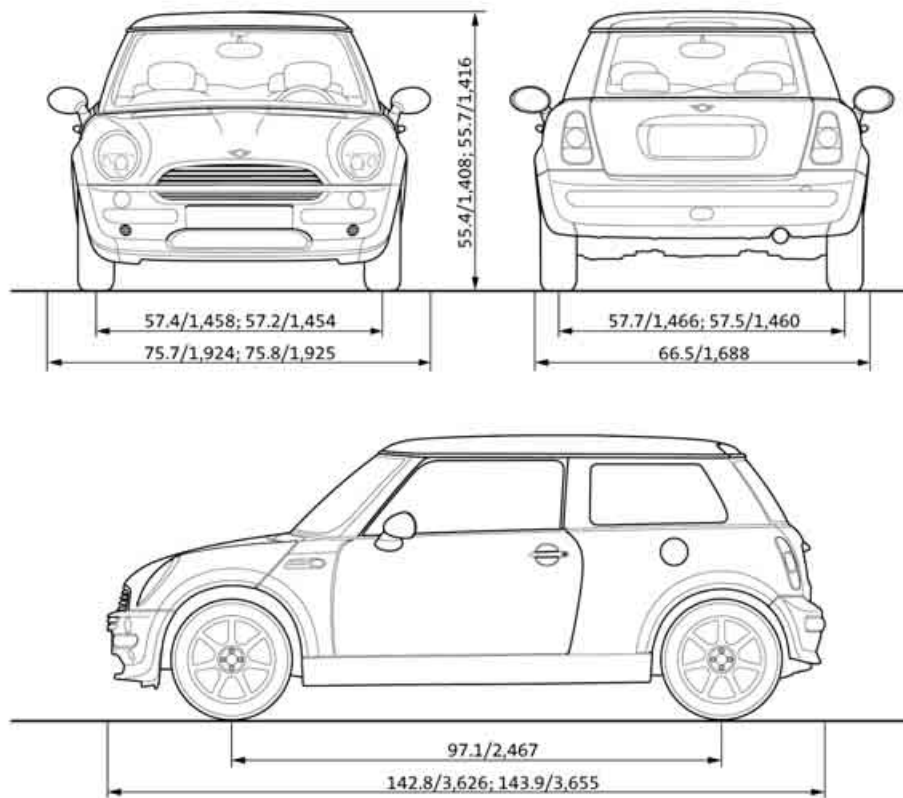

All measurements in inches / millimeters. Smallest turning circle dia. 35 ft / 10.66 m.  
Values following a ; are differing values for MINI COOPER S.

MY1619TCMD

## WEIGHTS

		MINI COOPER	MINI COOPER S
Curb weight, with all optional special equipment with manual transmission	lbs / kg	2,524 / 1,145	2,678 / 1,215
with Continuously Variable automatic Transmission (CVT)	lbs / kg	2,557 / 1,160	–
Approved gross vehicle weight with manual transmission	lbs / kg	3,340 / 1,515	3,494 / 1,585
with Continuously Variable automatic Transmission (CVT)	lbs / kg	3,373 / 1,530	–
Cargo and luggage load capacity	lbs / kg	816 / 370	816 / 370
Approved front axle load	lbs / kg	1,918 / 870	1,962 / 890
Approved rear axle load	lbs / kg	1,609 / 730	1,698 / 770
Approved roof load, with special MINI roof rack	lbs / kg	165 / 75	165 / 75
Cargo area volume with rear backrest folded down	cu ft / liters cu ft / liters	5.3 / 150 23.7 / 670	5.3 / 150 23.7 / 670



## CAPACITIES

			Notes
Fuel tank Reserve	gal. / liters	approx. 13.2 / 50 approx. 2.1 / 8	Fuel quality, refer to page 85
Windshield washer system Headlamp washer system	quarts / liters	approx. 2.1 / 2.0 approx. 2.6 / 2.5	More details, refer to page 98
Cooling system including heater circuit	quarts / liters	5.6 / 5.3 MINI COOPER 6.3 / 6.0 MINI COOPER S	More details, refer to page 100
Engine with oil filter change	quarts / liters	4.7 / 4.5 MINI COOPER 4.7 / 4.5 MINI COOPER S	High Performance Synthetic Oil: for more details, refer to page 99
Manual transmission	quarts / liters	approx. 2.1 / 2.0 MINI COOPER approx. 1.8 / 1.7 MINI COOPER S	Contact your MINI Dealer for more details
Continuously Variable automatic Trans- mission (CVT)	quarts / liters	approx. 4.2 / 4.0 MINI COOPER	Contact your MINI Dealer for more details



OVERVIEW

OVERVIEW

CONTROLS

CONTROLS

OPERATION, CARE, MAINTENANCE

OPERATION

OWNER SERVICE PROCEDURES

REPAIRS

TECHNICAL DATA

DATA

INDEX

INDEX

## EVERYTHING FROM A TO Z

- A**
- ABS Antilock Brake System 61
    - indicator lamp 16, 17
  - Accessories, refer to
    - For your own safety 7
    - Your individual vehicle 6
  - Activated-charcoal filter 72
  - Air circulation, refer to
    - Recirculated air mode 68, 71
  - Air conditioning
    - air conditioning system 68
    - automatic climate control 71
  - Air conditioning system 67
  - Air distribution
    - air conditioning system 68
    - automatic climate control 71
  - Air outlets, refer to
    - Ventilation 69, 72
  - Air pressure, refer to Tire
    - inflation pressure 87
  - Air supply
    - air conditioning system 68
    - automatic climate control 72
  - Air, drying, refer to Air
    - conditioning 68, 71
  - Airbags 65
    - indicator lamp 16
    - safe seating position 31
  - AKI, refer to Fuel quality 85
  - All Season traction Control (ASC) 59
    - indicator lamp 16, 17
  - All-season tires, refer to Winter tires 92
  - Antenna 103
  - Antifreeze
    - coolant 100
    - washer fluid 98
  - Antilock Brake System (ABS) 61
    - indicator lamp 16, 17
  - Approved axle load, refer to Weights 134
  - Approved engine oils 99
  - Approved gross vehicle weight, refer to Weights 134
  - ASC All Season traction Control 59
    - indicator lamp 16, 17
  - Ashtray 74
  - Assistant systems, refer to
    - All Season traction Control (ASC) 59
    - Dynamic Stability Control (DSC) 60
  - AUTO program, refer to
    - Automatic air distribution 71
  - Automatic
    - air distribution 71
    - air supply 71
    - cruise control 52
  - Automatic car washes 103
  - Automatic climate control 70
  - Automatic headlamp range control for xenon lamps, refer to Daytime driving lamps 48
  - Average consumption
    - setting units 58
  - Average speed
    - setting units 58
  - Axle loads, refer to Weights 134
- B**
- Backrests, refer to
    - Adjusting seats 33
  - Backup lamp 44
    - bulb replacement 114
  - Bar, towing 128
  - Battery 124
    - disposal 22, 124
    - indicator lamp 15
    - jump-starting 126
    - remote control 22
  - Belts, refer to Safety belts 35
  - Beverage holders 74
  - Blower
    - air conditioning system 68
    - automatic climate control 72
  - Blower, refer to Air flow 68, 72
  - Blowers, refer to Draft-free ventilation 69, 72
  - BMW 6
  - Bonnet 95
    - indicator lamp 16
  - Bore, refer to Engine data 132
  - Bottle holders, refer to
    - Beverage holders 74
  - Brake discs
    - brake system 86
    - break-in procedures 82
  - Brake fluid 101
    - adding 101
    - level 86
    - warning lamp 15
  - Brake lamps
    - bulb replacement 114
  - Brake pads 86
    - break-in procedures 82
    - warning lamp 16
  - Brake system 86
    - brake fluid level 86
    - brake pads 86
    - disc brakes 86
    - warning lamp 16
  - Brake wear warning
    - brake pads 86
    - warning lamp 16

## EVERYTHING FROM A TO Z

### Brakes 86

- ABS 61
- brake fluid 101
- break-in procedures 82
- handbrake 43
- indicator/warning lamps 15, 16

### Breaking in 82

### Bulb replacement, refer to

- Lamps and bulbs 111

### Buttons in multifunction

- steering wheel 18
- Continuously Variable automatic Transmission (CVT) 46

## C

### California Proposition

- 65 warning 107

### Capacities 135

### Car care, refer to Caring for your vehicle 103

### Car keys, refer to Keys 22

### Car radio, refer to separate

- Owner's Manual

### Car telephone, refer to separate

- Owner's Manual

### Car vacuum cleaner,

- connecting, refer to Cigarette lighter socket 74

### Car wash 103

### Car wash, refer to Washing your vehicle 103

### Car-care products 103

### Care, vehicle 103

### Cargo area 75

- cover 75
- emergency operation, refer to Manual operation 27
- foldable rear backrest 75
- lid, refer to Tailgate 27
- volume, refer to Weights 134

### Cargo area lamps

- bulb replacement 116

### Cargo area net 77

### Carpet care 104

### Cassette operation, refer to Owner's Manual for Radio

### Catalytic converter, refer to

- High temperatures 83

### CBC Cornering Brake Control 61

- warning lamp 16

### CD changer, refer to separate

- Owner's Manual

### CD operation, refer to

- Owner's Manual for Radio

### Center high-mount brake lamp

- bulb replacement 114

### Central locking system 23

- interior 26

### Changing bulbs, refer to Lamps and bulbs 111

### Changing tires

- space-saver spare tire 117

### Charge-current indicator light 15

### Child seat, refer to Child-restraint systems 38

### Child-restraint systems 38

### Chock, folding

- MINI Mobility System 121

### Run Flat tires 93

### space-saver spare tire 117

### Chrome parts, refer to Caring

- for your vehicle 104

### Chrome-plated parts, care 104

### Cigarette lighter 74

### Cigarette lighter socket 74

### Circulation of air, refer to

- Recirculated air mode 68, 71

### Cleaning the rear window 51

### Cleaning the vehicle, refer to Caring for your vehicle 103

### Clock 56

### Closing

- from inside 26
- from outside 23

### Clothes hooks 83

### Clutch

- break-in procedures 82

### Cockpit 12

### Cold start, refer to

- Starting the engine 41

### Compact disk operation, refer to Owner's Manual for Radio Compartments 73

### Compression, refer to Engine data 132

### Compressor, refer to MINI

- Mobility System

### operation, refer to

- Reinflating tires 122

### storage location 110

### Computer, refer to Onboard

- computer 57

### Condensed water, refer to Air conditioning 68, 71

### Configuring settings, refer to Vehicle Memory 37

### Consumption, refer to Average consumption 58

### Consumption, refer to Current consumption 58

### Contents 2

### Continuously Variable automatic Transmission (CVT) 45

### ignition 41

### indicator lamp 47

### interlock 41

- selector lever lock 45

### shiftlock 45

### towing 129

## EVERYTHING FROM A TO Z

- Control elements, refer to  
Cockpit 12
- Convenience operation  
from outside 24, 25  
glass sunroof, electric 29  
window 28
- Coolant 100  
indicator lamp 15  
level 100  
temperature 55
- Coolant temperature gauge 55
- Cooling system, refer to  
Capacities 135
- Cooling, refer to Air  
conditioning 68, 71
- Copyright 2
- Cornering Brake Control  
(CBC) 61  
warning lamp 16
- Cosmetic mirror, refer to  
Illuminated vanity mirror 36
- Cruise control 52  
indicator lamp 17  
multifunction steering  
wheel 18  
sports steering wheel 18
- Cup holders, refer to Beverage  
holders 74
- Curb weight, refer to  
Weights 134
- Current fuel consumption  
setting units 58
- Cylinders, refer to Engine  
data 132
- D**
- Daily odometer, refer to Trip  
odometer 54
- Dashboard lighting, refer to  
Instrument lighting 49
- Data, technical  
dimensions 133  
engine data 132  
weights 134
- Date of the Owner's Manual 7
- Daytime driving lamps 48
- Deep water, refer to Water on  
roadways 83
- Defrost setting, refer to  
Defrosting and demisting  
windows 69, 72
- Defrosting and demisting  
windows  
air conditioning system 69  
automatic climate control 72
- Defrosting windows 69, 72  
air conditioning system 68  
automatic climate control 71
- Defrosting windshield, refer to  
Defrosting and demisting  
windows 69, 72
- Demisting windows 69, 72
- Digital clock 56
- Dimensions 133
- Dimming interior rearview  
mirror 37
- Dipstick, engine oil 98
- Directional turn signal,  
refer to Turn signal  
indicators 49
- Disc brakes 86
- Displacement, refer to Engine  
data 132
- Display elements 13  
with navigation system 14
- Display lighting, refer to  
Instrument lighting 49
- Disposal  
oil 99  
remote control battery 22  
vehicle battery 124
- Distance covered, refer to  
Odometer 54
- Door keys 24
- Door lock 25
- Doors, locking and unlocking  
from inside 26  
from outside 24
- DOT quality grades 89
- Draft-free ventilation 69, 72
- Drink holders, refer to Beverage  
holders 74
- Driving lamps, refer to Parking  
lamps/Low beams 48
- Driving notes 83  
break-in procedures 82
- Driving stability control 59, 60
- Dry air, refer to Air  
conditioning 68, 71
- DSC Dynamic Stability  
Control 60  
indicator lamp 16
- DVD changer, refer to separate  
Owner's Manual
- Dynamic Stability Control  
(DSC) 60  
indicator lamp 16
- Dynamic  
Stability Control (DSC) 60
- E**
- Easy entry to the rear 34
- EBD Electronic Brake Force  
Distribution 61  
indicator lamp 16
- Electric glass sunroof 29
- Electric power windows 28  
initializing 28

## EVERYTHING FROM A TO Z

- Electrical malfunction
  - door lock [25](#)
  - driver's door [25](#)
  - glass sunroof, electric [30](#)
  - tailgate [27](#)
  - transmission lock for Continuously Variable automatic Transmission (CVT) [47](#)
- Electronic Brake Force Distribution (EBD) [61](#)
- indicator lamp [16](#)
- Electronic Stability Program (ESP), refer to Dynamic Stability Control (DSC) [60](#)
- Electronic transmission control module [47](#)
- Emergency operation, refer to Manual operation
  - driver's door [25](#)
  - glass sunroof, electric [30](#)
  - tailgate [27](#)
- Engine
  - break-in procedures [82](#)
  - data [132](#)
  - electronics [17](#)
  - indicator lamp [17](#)
  - speed [54](#)
  - starting [41](#)
  - switching off [43](#)
- Engine compartment
  - MINI COOPER [96](#)
  - MINI COOPER S [97](#)
- Engine coolant [100](#)
- Engine data [132](#)
- Engine oil [98](#)
  - alternative oils [99](#)
  - capacity [135](#)
  - indicator/warning lamp [15](#)
  - recommended oils [99](#)
- Engine oil level [98](#)
- indicator/warning lamp [15](#)
- Engine oil pressure indicator/warning lamp [15](#)
- Engine output, refer to Engine data [132](#)
- Engine speed, refer to Engine data [132](#)
- Entry to the rear [34](#)
- EP electronic transmission control module
  - Continuously Variable automatic Transmission (CVT) [47](#)
- Equipment and features, refer to Service and Warranty Information Booklet for US models, Warranty and Service Guide Booklet for Canadian models
- ESP Electronic Stability Program, refer to Dynamic Stability Control (DSC) [60](#)
- Exhaust system, refer to High temperatures [83](#)
- Exterior mirrors [36](#)
- Eyelet, towing [128](#)
- F**
  - Failure of an electrical consumer [125](#)
  - Fasten safety belts [35](#)
    - indicator lamp [16](#)
  - Filling canister, refer to MINI Mobility System [122](#)
  - Filling hose, refer to MINI Mobility System [122](#)
  - Filter, refer to Microfilter/activated-charcoal filter [72](#)
  - Flat tire
    - Flat Tire Monitor [62](#), [63](#)
    - indicator/warning lamp [16](#)
    - MINI Mobility System [121](#)
    - Run Flat tires [93](#)
    - space-saver spare tire [117](#)
    - tire condition [91](#)
  - Flat Tire Monitor [62](#)
    - indicator lamp [16](#), [17](#)
    - initializing [62](#)
  - Floor coverings and carpets [104](#)
  - Floor mat [104](#)
  - Fog lamps [49](#)
    - bulb replacement [113](#)
    - indicator lamp [49](#)
  - Foldable rear backrest [75](#)
  - 'Follow me home' lamps [48](#)
  - Foot brake, refer to Driving notes [83](#)
  - Footwell lamps [50](#)
    - bulb replacement [116](#)
  - Front airbags [65](#)
  - Fuel
    - average consumption [58](#)
    - gauge [54](#), [55](#)
    - mixture preparation, refer to Engine data [132](#)
    - quality [85](#)
    - volume, refer to Capacities [135](#)
  - Fuel filler cap
    - unlocking in the event of electrical malfunction [84](#)
  - Fuel tank capacity, refer to Capacities [135](#)
  - Fuses [125](#)
- G**
  - Gas cap [84](#)
  - Gasoline gauge, refer to Fuel gauge [54](#), [55](#)

## EVERYTHING FROM A TO Z

- Gasoline, refer to Fuel quality [85](#)
- Gear indicator [47](#)
- Gearshift lever
  - Continuously Variable automatic Transmission (CVT) [45](#)
  - manual transmission [44](#)
- General driving notes [83](#)
- Glass sunroof, electric [29](#)
  - convenience
  - operation [24](#), [25](#)
  - pinch protection [30](#)
- Glove compartment [73](#)
- Glove compartment lamp
  - bulb replacement [116](#)
- Gross weight, refer to Weights [134](#)
- H**
- Handbrake, refer to Parking brake [43](#)
- Hazard warning flashers [12](#)
- Head airbags [65](#)
- Head restraints [33](#)
- Headlamp flasher [49](#)
  - indicator lamp [17](#)
- Headlamp washer
  - cleaning headlamps [51](#)
  - washer fluid [98](#)
- Headlamp washer reservoir [98](#)
  - capacity, refer to Capacities [135](#)
- Headlamps
  - bulb replacement [112](#)
  - care [103](#)
  - cleaning [51](#)
- Heated mirrors [36](#)
- Heated rear window
  - air conditioning system [68](#)
  - automatic climate control [71](#)
- Heating [67](#)
  - exterior mirrors [36](#)
  - rear window [68](#), [71](#)
  - seats [35](#)
  - windshield [68](#), [71](#)
- Heavy load, refer to Loading cargo [77](#)
- Height adjustment
  - seats [32](#)
  - steering wheel [36](#)
- Height, refer to Dimensions [133](#)
- Hex wrench [121](#)
- High beams [49](#)
  - bulb replacement [112](#)
  - headlamp flasher [49](#)
  - indicator lamp [17](#)
- High Performance Synthetic Oil, refer to Engine oil [99](#)
  - alternative oils [99](#)
  - capacity [135](#)
  - recommended oils [99](#)
  - specified oils [99](#)
- High temperatures [83](#)
- Holders for beverages [74](#)
- Horn [12](#)
- Hydroplaning [83](#)
- I**
- Ice warning [57](#)
- Identification mark
  - Run Flat tires [93](#)
- Ignition [41](#)
- Ignition key [22](#)
- Ignition lock [41](#)
- Illuminated vanity mirror [36](#)
- Illumination
  - of instruments [49](#)
- Imitation leather [104](#)
- Imprint [2](#)
- Index [138](#)
- Indicator and warning lamps, overview [15](#)
- Indicator/warning lamp
  - airbags [65](#)
  - ASC [59](#)
  - brakes [101](#)
  - coolant temperature [55](#)
  - DSC [60](#)
  - fasten safety belts [35](#)
  - Flat Tire Monitor [63](#)
  - fog lamps [49](#)
  - reserve fuel capacity [54](#), [55](#)
- Individual air distribution [72](#)
- Individual settings, refer to Vehicle Memory [37](#)
- Inflation pressure monitor, refer to Flat Tire Monitor [62](#)
- Inflation pressure, tires [87](#)
- Inspection [56](#)
- Instrument cluster, refer to Display elements [13](#)
- Instrument lighting [49](#)
- Instrument panel, refer to Cockpit [12](#)
- Interior lamps [50](#)
  - bulb replacement [115](#)
- Interior rearview mirror [36](#)
  - automatic dimming [37](#)
- Interior temperature
  - settings [68](#), [71](#)
- Interlock, refer to Steering locked [41](#)



## EVERYTHING FROM A TO Z

Intermittent operation  
wipers 50  
Interval display, service 102

### J

Jack, refer to Tire change set  
MINI Mobility System 121  
Run Flat tires 93  
space-saver spare tire 117  
Jacking points 119  
Jets, refer to Ventilation 69, 72  
Jets, refer to Windshield  
washer jets 51  
Jump-starting 126

### K

Keys 22  
Kickdown 46  
Knock control 85

### L

Lamp defect 111  
Lamp replacement, refer to  
Lamps and bulbs 111  
Lamps and bulbs 111  
Lamps, refer to Parking lamps/  
Low beams 48  
Lashing eyes, refer to Securing  
the load 77  
LATCH child-restraint  
mounting system 40

Leather care 105  
LEDs light-emitting diodes 50  
Length, refer to  
Dimensions 133  
License plate lamp  
bulb replacement 115  
Lifting handle, space-saver  
spare tire, refer to Tire  
change set 117  
Light switch 48  
Light-alloy wheels, care 104  
Light-emitting diodes 50  
Lighter 74  
'Lights on' warning 48  
Load securing devices, refer to  
Securing the load 77  
Loading cargo  
vehicle 76  
Loads, refer to Loading cargo 76  
Locking  
from inside 26  
from outside 24  
Low beams 48  
bulb replacement 112  
Lower back support, refer to  
Lumbar support 33  
Luggage compartment  
capacity, refer to Cargo area  
volume 134  
Luggage compartment cover,  
refer to Cargo area cover 75

Luggage compartment lamps,  
refer to Cargo area lamps 116  
Luggage compartment lid  
emergency operation, refer  
to Manual operation 27  
Luggage compartment lid, refer  
to Tailgate 27  
Luggage compartment, refer to  
Cargo area 75  
Luggage rack, refer to Roof-  
mounted luggage rack 78  
Lumbar support 33

### M

M+S tires, refer to Winter  
tires 92  
Maintenance system 102  
Maintenance, refer to Service  
interval display 56, 102  
Malfunction  
door lock 25  
glass sunroof, electric 30  
tailgate 27  
Manual mode, refer to  
Continuously Variable  
automatic Transmission  
(CVT) 46  
Manual operation  
door lock 25  
driver's door 25  
fuel filler cap 84  
glass sunroof, electric 30  
tailgate 27  
Manual transmission 44  
Manufacturer 6  
Master key  
initializing 22  
with remote control 22  
MC operation, refer to  
Owner's Manual for Radio  
Memory, refer to Vehicle  
Memory 37  
MFL Multifunction steering  
wheel 18  
Microfilter  
air conditioning system 69  
automatic climate control 72  
MINI Maintenance System 102  
MINI manufacturer 6  
MINI Mobility System 121  
compressor 122  
liquid sealant 122  
Mirrors 36  
heating 36  
Mobility System 121  
Modifications, technical, refer  
to For your own safety 7

## EVERYTHING FROM A TO Z

Multifunction sports steering wheel [19](#)

Multifunction steering wheel [18](#)

Multifunction switch  
turn signal indicator/  
headlamp flasher [49](#)  
washer/wiper system [50](#)

### N

Navigation system, refer to separate Owner's Manual

Neck restraints, refer to Head restraints [33](#)

New tires [92](#)

Non-smoker's equipment package, refer to Cigarette lighter socket [74](#)

Nylon rope [128](#)

### O

OBD interface socket [106](#)

Octane number, refer to Fuel quality [85](#)

Odometer [54](#)

Oil [56](#)

Oil change intervals, refer to Service and Warranty Information Booklet for US

models, Warranty and Service Guide Booklet for Canadian models

Oil consumption [99](#)

Oil filter change [135](#)

Oil level [98](#)  
indicator/warning lamp [15](#)

Oil level, measuring [98](#)

Oil pressure  
indicator/warning lamp [15](#)

Oil, refer to Engine oil alternative oils [99](#)

capacity [135](#)

dipstick [98](#)

indicator/warning lamp [15](#)  
recommended oils [99](#)

Onboard computer [57](#)

Onboard tool kit [110](#)  
MINI Mobility System [121](#)  
space-saver spare tire [117](#)

Opening and closing  
from inside [26](#)  
from outside [23](#)  
via remote control [23](#)  
via the door lock [25](#)

Outlets, refer to  
Ventilation [67, 70](#)

Outside temperature display [57](#)  
changing units [57](#)  
in the onboard computer [57](#)

### P

Paintwork care, refer to Vehicle paintwork [103](#)

Park Distance Control (PDC) [64](#)

Parking aid, refer to Park Distance Control (PDC) [64](#)

Parking brake [43](#)  
warning lamp [16](#)

Parking lamps [48](#)  
bulb replacement [112](#)

Parking lamps/Low beams [48](#)

Parking lock, refer to  
Transmission lock [46](#)

Parking the vehicle [83](#)

Parts and accessories, refer to  
Your individual vehicle [6](#)

PDC Park Distance Control [64](#)

Pinch protection  
glass sunroof, electric [30](#)

Plastic [104](#)

Pollen, refer to  
Microfilter [69](#)  
Microfilter/activated-  
charcoal filter [72](#)

Power output, refer to Engine data [132](#)

Power supply, refer to Cigarette lighter socket [74](#)

Power windows [28](#)

Pressure monitor, tires  
Flat Tire Monitor [62](#)

Pressure, tires [87](#)  
production using MINI  
Mobility System [122](#)

Pumping in liquid sealant [122](#)

### Q

Quality grades, refer to  
Uniform Tire Quality  
Grading [89](#)

### R

Radiator, refer to Coolant [100](#)

Radio, refer to separate  
Owner's Manual

Rain sensor [50](#)

Range [58](#)

Reading lamps [50](#)  
bulb replacement [115](#)

Rear backrests  
folding [75](#)

Rear fog lamp [49](#)  
bulb replacement [113](#)  
indicator lamp [49](#)

Rear lamps, refer to Tail lamps [113](#)  
bulb replacement [113, 114](#)

Rear seats  
adjusting head restraints [33](#)

Rear shelf, refer to Cargo area cover [75](#)

## EVERYTHING FROM A TO Z

- Rear turn signal indicator bulb replacement [113](#)
- Rear window wiper [51](#)
  - replacement [111](#)
- Rearview mirror [36](#)
- Recirculated air mode
  - air conditioning system [68](#)
  - automatic climate control [71](#)
- Reclining seat, refer to Backrest tilt [33](#)
- Refueling [84](#)
- Remaining distance for service [56](#)
- Remaining distance, refer to Range [58](#)
- Remote control [23](#)
  - changing battery [22](#)
  - initializing [22](#)
  - malfunctions [25](#)
- Remote control key, refer to Master key with remote control [22](#)
- Replacement key [22](#)
- Replacement of tires [92](#)
  - changing tires [117](#)
- Reporting safety defects [9](#)
- Reserve indicator light, refer to Fuel gauge [54](#), [55](#)
- Reservoir
  - washer system [98](#)
- Restraint systems
  - for children [38](#)
  - refer to Safety belts [35](#)
- Reverse
  - Continuously Variable automatic Transmission (CVT) [46](#)
  - manual transmission [44](#)
- Rod antenna [103](#)
- Roller sun blind [30](#)
- Roof load, refer to Weights [134](#)
- Roof-mounted luggage rack [78](#)
- Rope, refer to Towing [128](#)
- RSC Runflat System
  - Component, refer to Run Flat tires [93](#)
- Rubber parts [104](#)
- Run Flat tires [93](#)
  - tire failure [93](#)
  - tire inflation pressure [87](#)
- Runflat System Component (RSC), refer to Run Flat tires [93](#)
- S**
- Safety belt height adjustment [35](#)
- Safety belts [35](#)
  - care [104](#)
  - height adjustment [35](#)
  - safe seating position [31](#)
  - warning lamp [16](#), [35](#)
- Safety lock buttons, doors, refer to Locking [26](#)
- Safety systems, refer to
  - All Season traction Control (ASC) [59](#)
  - Antilock Brake System (ABS) [61](#)
  - Dynamic Stability Control (DSC) [60](#)
- Screwdriver, refer to Onboard tool kit [110](#)
- Seat adjustment [32](#)
- Seat heating [35](#)
- Securing loads, refer to Loading cargo [76](#)
- Securing the load [77](#)
- Securing the vehicle
  - from inside [26](#)
  - from outside [24](#)
- Selector lever
  - Continuously Variable automatic Transmission (CVT) [45](#)
- Selector lever positions
  - Continuously Variable automatic Transmission (CVT) [45](#)
- Selector lever shiftlock, refer to Shiftlock [45](#)
- Service [56](#)
- Service interval display [56](#), [102](#)
- Service, refer to Service and Warranty Information Booklet for US models, Warranty and Service Guide Booklet for Canadian models [102](#)
- Shifting
  - Continuously Variable automatic Transmission (CVT) [46](#)
  - manual transmission [44](#)
- Shifting gears, refer to Continuously Variable automatic Transmission (CVT) [45](#)
- Shiftlock, refer to Range selection [45](#)
- Side airbags [65](#)
- Side turn signal indicators
  - bulb replacement [113](#)
- Signal horn, refer to Horn [12](#)

## EVERYTHING FROM A TO Z

- Sitting safely [31](#)
  - with airbags [31](#)
  - with safety belt [31](#)
- Size, refer to Dimensions [133](#)
- Sliding/tilt sunroof, refer to
  - Glass sunroof, electric [29](#)
- Smoker's equipment package, refer to Ashtray [74](#)
- Snow chains [94](#)
- Socket 12 V [74](#)
- Socket, for onboard diagnostics [106](#)
- Space-saver spare tire changing tires [117](#)
- Spare key [22](#)
- Spare tire, refer to Space-saver spare tire [117](#)
- Special oils, refer to Specified engine oils [99](#)
- Special wash program, refer to Washing your vehicle [103](#)
- Specified engine oils [99](#)
- Speed control, refer to Cruise control [52](#)
- Speedometer [13, 14](#)
- Split rear backrest, refer to Foldable rear backrest [75](#)
- Sport program
  - Continuously Variable automatic Transmission (CVT) [46](#)
- Stability control
  - All Season traction Control (ASC) [59](#)
  - Dynamic Stability Control (DSC) [60](#)
- Standing lamps [48](#)
  - bulb replacement [112](#)
- Starting aid
  - All Season traction Control (ASC) [59](#)
  - Dynamic Stability Control (DSC) [60](#)
- Starting aid, refer to Jump-starting [126](#)
- Starting problems
  - jump-starting [126](#)
  - temperature [42](#)
- Starting the engine [41](#)
- Steering lock [41](#)
- Steering wheel [12](#)
  - settings [36](#)
- Steering wheel lock [41](#)
- Steering wheel with multifunction buttons [18](#)
- Storage compartments [73](#)
- Storage space, refer to Cargo area [75](#)
- Storage, tires [92](#)
- Storing the vehicle [105](#)
- Stroke, refer to Engine data [132](#)
- Sun blind, refer to Roller sun blind [30](#)
- Sun visors [36](#)
- Surface ice, refer to Ice warning [57](#)
- Switches, refer to Cockpit [12](#)
- Switching off the engine [43](#)
- Switching the air conditioning on and off manually [68, 71](#)
- Symbols [6](#)
- T**
- Tachometer [54](#)
- Tail lamps
  - bulb replacement [114](#)
- Tailgate [27](#)
  - emergency operation, refer to Manual operation [27](#)
  - indicator lamp [16](#)
  - to open from the outside [27](#)
- Tank capacity, refer to Fuel tank capacity [135](#)
- Tank gauge, refer to Fuel gauge [54, 55](#)
- Technical data [132](#)
- Technical modifications, refer to For your own safety [7](#)
- Temperature
  - air conditioning system [68](#)
  - automatic climate control [71](#)
  - engine [55](#)
- Temperature display
  - ice warning [57](#)
  - outside temperature [57](#)
  - setting units [57](#)
- Temperature grades [90](#)
- Third brake lamp
  - bulb replacement [114](#)
- Third brake lamp, refer to Center high-mount brake lamp [114](#)
- Three-point seat belt, refer to Safety belts [35](#)
- Tightening the lug bolts keys [117, 121](#)
- Tightening torque, refer to Tightening the lug bolts [120](#)
- Tire change set
  - MINI Mobility System [123](#)
  - Run Flat tires [93](#)
  - space-saver spare tire [117](#)
- Tire failure [116](#)
  - MINI Mobility System [121](#)
  - space-saver spare tire [117](#)
- Tire inflation pressure [87, 123](#)
  - reinflation [122](#)
- Tire pressure monitor, refer to Flat Tire Monitor [62](#)

## EVERYTHING FROM A TO Z

### Tires

- age [89](#)
  - break-in procedures [82](#)
  - changing [117](#)
  - condition [91](#)
  - damage [91](#)
  - flat tire [93](#), [116](#)
  - inflation pressure [87](#)
  - replacement [92](#)
  - storage [92](#)
  - tread [91](#)
  - wear indicator, refer to Tire tread [91](#)
  - winter tires [92](#)
- Tools, refer to Onboard tool kit [110](#)
- Torque, refer to Engine data [132](#)
- Tow
- bar [128](#)
  - eyelet [128](#)
  - rope [128](#)
- Tow fitting, refer to Towing eyelet [128](#)
- Tow socket for towing eyelet [128](#)
- Towing [128](#)
- with automatic transmission [129](#)
- Towing eyelet [128](#)

### Track width, refer to

- Dimensions [133](#)
- Traction grades [90](#)
- Transmission
- Continuously Variable automatic Transmission (CVT) [45](#)
  - manual transmission [44](#)
- Transmission lock, refer to Range selection [45](#)
- Transmission malfunction [47](#)
- Transporting children [38](#)
- Transporting children safely [38](#)
- Trash container, refer to Ashtray [74](#)
- Tread depth, refer to Tire tread [91](#)
- Treadwear grade [89](#)
- Trip odometer [54](#)
- Trunk, refer to Cargo area [75](#)
- Turn signal indicators [49](#)
- indicator lamp [17](#)
- Turn signal indicators, front bulb replacement [112](#)
- Turn signal indicators, side bulb replacement [113](#)
- Turning circle, refer to Dimensions [133](#)

### U

- Uniform Tire Quality Grading [89](#)
- Units
- average consumption [58](#)
  - average speed [58](#)
  - temperature [57](#)
- Unlocking
- bonnet [95](#)
  - from inside [26](#)
  - from outside [24](#)
- Used batteries, refer to Disposal [124](#)
- Using antifreeze [98](#), [100](#)

### V

- Vacuum cleaner, connecting, refer to Cigarette lighter socket [74](#)
- Valve
- core [121](#)
  - dust cap [118](#)
  - remover [121](#)
  - spare [121](#)
- Valve remover, refer to Onboard tool kit [121](#)
- Valve stem and replacement valve, refer to Onboard tool kit [121](#)

### Vanity mirror

- bulb replacement [115](#)
  - illuminated [36](#)
- Vehicle
- battery [124](#)
  - break-in procedures [82](#)
  - care [103](#)
  - dimensions [133](#)
  - loading cargo [76](#)
  - storage [105](#)
  - switching off [83](#)
  - washing [103](#)
  - weight [134](#)
- Vehicle Memory [37](#)
- Ventilation
- draft-free [69](#), [72](#)
- Volume
- cargo area, refer to Weights [134](#)
  - fuel tank, refer to Capacities [135](#)
- ### W
- Warning and indicator lamps [15](#)
- Warranty, refer to Service and Warranty Information Booklet for US models, Warranty and Service Guide Booklet for Canadian models [102](#)

## EVERYTHING FROM A TO Z

- Washer fluid [98](#)
  - Washer fluid reservoir, refer to
    - Capacities [135](#)
  - Washer fluid reservoir, refer to
    - Washer/Wiper system [98](#)
  - Washer systems [98](#)
  - Washer/wiper system [50](#)
  - Washing your vehicle [103](#)
  - Water on roadways, deep water [83](#)
  - Wear indicators in the tires, refer to Tire tread/Tire damage [91](#)
  - Weights [134](#)
  - Wheel stud wrench
    - MINI Mobility System [121](#)
    - space-saver spare tire [117](#)
  - Wheelbase, refer to
    - Dimensions [133](#)
  - Wheelslip control
    - All Season traction Control (ASC) [59](#)
    - Dynamic Stability Control (DSC) [60](#)
  - Width, refer to Dimensions [133](#)
  - Window
    - convenience operation [24](#), [25](#)
  - Windscreen wipers
    - replacement [110](#), [111](#)
  - Windshield heating
    - air conditioning system [68](#)
    - automatic climate control [71](#)
  - Windshield washer jets [51](#)
  - Windshield washer reservoir [98](#)
    - refer to Capacities [135](#)
  - Windshield washer system
    - washer fluid [98](#)
    - washer/wiper system [50](#)
  - Windshield wiper blades
    - care [104](#)
    - replacement [110](#), [111](#)
  - Windshield wipers, refer to
    - Washer/wiper system [50](#)
  - Windshield, cleaning [51](#)
  - Winter tires
    - changing [117](#)
    - storage [92](#)
  - Winter tires, refer to Special characteristics of winter tires [92](#)
  - Wood paneling [104](#)
  - Work in the engine compartment [95](#)
  - Wrench, refer to Onboard tool kit [110](#)
- X**
- Xenon lamps
    - bulb replacement [112](#)
    - daytime driving lamps [48](#)

## REFUELING

<b>Fuel</b>	
Designation	
AKI:	

<b>Engine oil</b>	
Quality	

The oil volume between the two notches on the dipstick corresponds to approx. 1.1 US quarts / 1 liter.

Tire inflation pressure	Summer		Winter	
	front	rear	front	rear
2 persons				
4 persons plus luggage				



To ensure that you always have convenient access to all essential information when you stop for fuel, we recommend that you take the time to fill out the adjoining chart by entering the data that applies to your vehicle.

MINI RECOMMENDS 



**DRIVE ME.**