



Contents A-Z

OWNER'S MANUAL.

MINI COUNTRYMAN.

MINI PACEMAN.



**COOPER
COOPER S
JOHN COOPER
WORKS**

Owner's Manual for Vehicle

Thank you for choosing a MINI.

The more familiar you are with your vehicle, the better control you will have on the road. We therefore strongly suggest:

Read this Owner's Manual before starting off in your new MINI. It contains important information on vehicle operation that will help you make full use of the technical features available in your MINI. The manual also contains information designed to enhance operating reliability and road safety, and to contribute to maintaining the value of your MINI.

Supplementary information can be found in the additional brochures in the onboard literature.

Set off now. We wish you a lot of pleasure and enjoyment driving your MINI.

© 2015 Bayerische Motoren Werke
Aktiengesellschaft
Munich, Germany
Reprinting, including excerpts, only with the written
consent of BMW AG, Munich.
US English VI/15, 07 15 500
Printed on environmentally friendly paper, bleached
without chlorine, suitable for recycling.

CONTENTS

The fastest way to find information on a particular topic or item is by using the index, refer to page 270.

6 Information

AT A GLANCE

- 12 Cockpit
- 18 Onboard monitor
- 24 Voice activation system

CONTROLS

- 30 Opening and closing
- 44 Adjusting
- 53 Transporting children safely
- 58 Driving
- 68 Displays
- 78 Lamps
- 82 Safety
- 93 Driving stability control systems
- 97 Driving comfort
- 100 Climate
- 105 Interior equipment
- 115 Storage compartments

DRIVING TIPS

- 120 Things to remember when driving
- 124 Loading
- 128 Saving fuel

NAVIGATION

- 132 Navigation system
- 134 Destination entry
- 143 Destination guidance
- 151 What to do if...

ENTERTAINMENT

- 154 Tone
- 156 Radio
- 164 CD/multimedia

COMMUNICATION

- 178 Bluetooth hands-free system
- 188 Bluetooth mobile phone preparation package
- 200 Office
- 208 MINI Connected

MOBILITY

- 214 Refueling
- 216 Fuel
- 218 Wheels and tires
- 230 Engine compartment
- 232 Engine oil
- 234 Coolant
- 236 Maintenance
- 238 Replacing components
- 248 Breakdown assistance
- 254 Care

REFERENCE

- 260 Technical data
- 264 Short commands for voice activation
- 270 Everything from A to Z

INFORMATION

USING THIS OWNER'S MANUAL

The fastest way to find information on a particular topic is by using the index.

An initial overview of the vehicle is provided in the first chapter.

Additional sources of information

A dealer's service center will be glad to answer any questions you may have.

Information about MINI, e.g., on technology, is available on the Internet: www.mini.com

Information about MINI, e.g., on technology, is available on the Internet: www.miniusa.com

SYMBOLS

 Indicates precautions that must be followed precisely in order to avoid the possibility of personal injury and serious damage to the vehicle.

◄ Marks the end of a specific item of information.

"..." Identifies Control Display texts used to select individual functions.

>...< Verbal instructions to use with the voice activation system.

>>...<< Identifies the answers generated by the voice activation system.

 Refers to measures that can be taken to help protect the environment.

Symbols on vehicle components

 Indicates that you should consult the relevant section of this Owner's Manual for information on a particular part or assembly.

VEHICLE FEATURES AND OPTIONS

The manufacturer of your MINI is the Bayerische Motoren Werke Aktiengesellschaft, BMW AG.

This Owner's Manual describes all models and all standard, country-specific and optional equipment that is offered in the model series. Therefore, in this Owner's Manual, we also describe and illustrate features that are not available in your vehicle, e.g., because of the selected optional features or the country-specific version.

This also applies to safety-related functions and systems.

For options and equipment not described in this Owner's Manual, please refer to the Supplementary Owner's Manuals.

STATUS OF THE OWNER'S MANUAL

The manufacturer of your vehicle pursues a policy of constant development that is conceived to ensure that our vehicles continue to embody the highest quality and safety standards. In rare cases, therefore, the features described in this Owner's Manual may differ from those in your vehicle.

OWN SAFETY

Warranty

Your vehicle is technically configured for the operating conditions and registration requirements applying in the country of first delivery also known as homologation. If your vehicle is to be operated in a different country it might

be necessary to adapt your vehicle to potentially differing operating conditions and permit requirements. If your vehicle does not comply with the homologation requirements in a certain country you may not be able to lodge warranty claims for your vehicle there. Further information on warranty is available from a dealer's service center.

Maintenance and repairs

Advanced technology, e.g., the use of modern materials and high-performance electronics, requires suitable maintenance and repair work. The manufacturer of your vehicle recommends that you entrust corresponding procedures to a MINI dealer's service center. If you choose to use another service facility, the manufacturer of your vehicle recommends use of a facility that performs work, e.g. maintenance and repair, according to MINI specifications with properly trained personnel, referred to in this Owner's Manual as "another qualified service center or repair shop".

If work is performed improperly, e.g. maintenance and repair, there is a risk of subsequent damage and related safety risks.

Parts and accessories

The manufacturer of your vehicle recommends the use of parts and accessory products approved by the manufacturer of the MINI.

Approved parts and accessories, and advice on their use and installation are available from a MINI dealer's service center.

MINI parts and accessories were tested by the manufacturer of the MINI for their safety and suitability in MINI vehicles.

The manufacturer of your vehicle warrants genuine MINI parts and accessories.

The manufacturer of your vehicle does not evaluate whether each individual product from another manufacturer can be used with MINI vehicles without presenting a safety hazard, even if a country-specific official approval was

issued. The manufacturer of your vehicle does not evaluate whether these products are suitable for MINI vehicles under all usage conditions.

California Proposition 65 Warning

California laws require us to state the following warning:

Engine exhaust and a wide variety of automobile components and parts, including components found in the interior furnishings in a vehicle, contain or emit chemicals known to the State of California to cause cancer and birth defects and reproductive harm. In addition, certain fluids contained in vehicles and certain products of component wear contain or emit chemicals known to the State of California to cause cancer and birth defects or other reproductive harm. Battery posts, terminals and related accessories contain lead and lead compounds. Wash your hands after handling. Used engine oil contains chemicals that have caused cancer in laboratory animals. Always protect your skin by washing thoroughly with soap and water.

Service and warranty

We recommend that you read this publication thoroughly. Your vehicle is covered by the following warranties:

- ▷ New Vehicle Limited Warranty.
- ▷ Rust Perforation Limited Warranty.
- ▷ Federal Emissions System Defect Warranty.
- ▷ Federal Emissions Performance Warranty.
- ▷ California Emission Control System Limited Warranty.

Detailed information about these warranties is listed in the Service and Warranty Information Booklet for US models or in the Warranty and Service Guide Booklet for Canadian models.

Your vehicle has been specifically adapted and designed to meet the particular operating conditions and homologation requirements in your country and continental region in order to de-

live the full driving pleasure while the vehicle is operated under those conditions. If you wish to operate your vehicle in another country or region, you may be required to adapt your vehicle to meet different prevailing operating conditions and homologation requirements. You should also be aware of any applicable warranty limitations or exclusions for such country or region. In such case, please contact Customer Relations for further information.

Maintenance

Maintain the vehicle regularly to sustain the road safety, operational reliability and the New Vehicle Limited Warranty.

Specifications for required maintenance measures:

- ▷ MINI Maintenance system
- ▷ Service and Warranty Information Booklet for US models
- ▷ Warranty and Service Guide Booklet for Canadian models

If the vehicle is not maintained according to these specifications, this could result in serious damage to the vehicle. Such damage is not covered by the MINI New Vehicle Limited Warranty.

DATA MEMORY

Many electronic components on your vehicle are equipped with data memories that temporarily or permanently store technical information about the condition of the vehicle, events and faults. This technical information generally records the state of a component, a module, a system or the environment:

- ▷ Operating mode of system components, fill levels for instance.
- ▷ Status messages for the vehicle and from its individual components, e.g., wheel rotation speed/vehicle speed, deceleration, transverse acceleration.

- ▷ Malfunctions and malfunctions in important system components, e.g., lights and brakes.
- ▷ Responses by the vehicle to special situations such as airbag deployment or engaging the stability control system.
- ▷ Ambient conditions, such as temperature.

This data is purely technical in nature and is used to detect and correct faults and to optimize vehicle functions. Motion profiles over routes traveled cannot be created from this data. When service offerings are used, e.g., repair services, service processes, warranty claims, quality assurance, this technical information can be read out from the event and fault memories by employees of the dealer's service center or another qualified service center or repair shop, including the manufacturer, using special diagnostic tools. You can obtain further information there if you need it. After an error is corrected, the information in the fault memory is deleted or overwritten on a continuous basis.

With the vehicle in use there are situations where you can associate these technical data with individuals if combined with other information, e.g., an accident report, damage to the vehicle, eye witness accounts — possibly with the assistance of an expert.

Additional functions that are contractually agreed with the customer - such as vehicle emergency locating - you can transmit certain vehicle data from the vehicle.

EVENT DATA RECORDER EDR

This vehicle is equipped with an event data recorder EDR. The main purpose of an EDR is to record, in certain crash or near crash-like situations, such as an air bag deployment or hitting a road obstacle, data that will assist in understanding how a vehicle's systems performed. The EDR is designed to record data related to vehicle dynamics and safety systems for a short period of time, typically 30 seconds or less.

The EDR in this vehicle is designed to record such data as:

- ▶ How various systems in your vehicle were operating.
- ▶ Whether or not the driver and passenger safety belts were fastened.
- ▶ How far, if at all, the driver was depressing the accelerator and/or brake pedal.
- ▶ How fast the vehicle was traveling.

These data can help provide a better understanding of the circumstances in which crashes and injuries occur.

EDR data are recorded by your vehicle only if a nontrivial crash situation occurs; no data are recorded by the EDR under normal driving conditions and no personal data, e.g., name, gender, age, and crash location, are recorded.

However, other parties, such as law enforcement, could combine the EDR data with the type of personally identifying data routinely acquired during a crash investigation.

To read data recorded by an EDR, special equipment is required, and access to the vehicle or the EDR is needed. In addition to the vehicle manufacturer, other parties, such as law enforcement, that have the special equipment, can read the information if they have access to the vehicle or the EDR.

REPORTING SAFETY DEFECTS

For US customers

The following only applies to vehicles owned and operated in the US.

If you believe that your vehicle has a defect which could cause a crash or could cause injury or death, you should immediately inform the National Highway Traffic Safety Administration NHTSA, in addition to notifying BMW of North America, LLC, P.O. Box 1227, Westwood, New Jersey 07675-1227, Telephone 1-800-831-1117.

If NHTSA receives similar complaints, it may open an investigation, and if it finds that a safety defect exists in a group of vehicles, it may order a recall and remedy campaign.

However, NHTSA cannot become involved in individual problems between you, your dealer, or BMW of North America, LLC.

To contact NHTSA, you may call the Vehicle Safety Hotline toll-free at 1-888-327-4236 (TTY: 1-800-424-9153); go to <http://www.safercar.gov>; or write to: Administrator, NHTSA, 400 Seventh Street, SW., Washington, DC 20590. You can also obtain other information about motor vehicle safety from <http://www.safercar.gov>

For Canadian customers

Canadian customers who wish to report a safety-related defect to Transport Canada, Defect Investigations and Recalls, may telephone the toll-free hotline 1-800-333-0510. You can also obtain other information about motor vehicle safety from <http://www.tc.gc.ca/roadsafety>.



WATCH ME.

AT A GLANCE

CONTROLS

DRIVING TIPS

NAVIGATION

ENTERTAINMENT

COMMUNICATION

MOBILITY

REFERENCE

COCKPIT

VEHICLE FEATURES AND OPTIONS

This chapter describes all standard, country-specific and optional features offered with the series. It also describes features that are not

necessarily available in your car, e. g., due to the selected options or country versions. This also applies to safety-related functions and systems.

When using the features and systems described here, adhere to local regulations.

ALL AROUND THE STEERING WHEEL

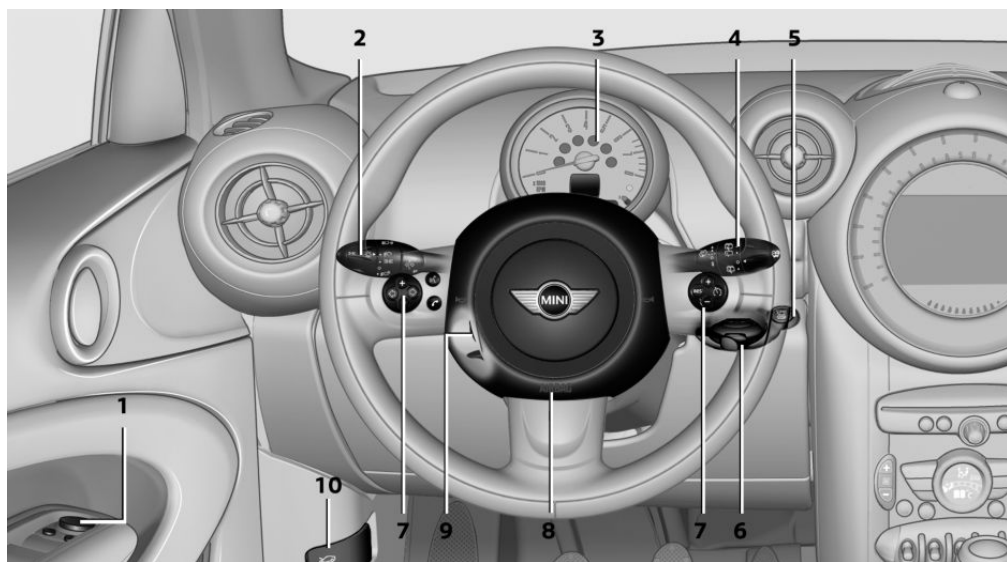

1 Setting the exterior mirror, folding it in and out [50](#)



Power windows, front [42](#)



MINI Countryman: power windows, rear [42](#)



MINI Countryman: safety switch for rear power windows [43](#)

2  Parking lights [78](#)



Low beams [78](#)



















Automatic headlamp control [78](#)

Adaptive Light Control [80](#)



Turn signal [61](#)

-  High-beams [61](#)
 Headlight flasher [61](#)
 Roadside parking lights [79](#)
 Computer [69](#)
- 3** Tachometer [69](#)
 Instrument lighting [80](#)
 Resetting the trip odometer [68](#)
- 4**  Washer/wiper system [61](#)
- 5**  Start/stop the engine and switch the ignition on/off [58](#)
- 6** Ignition lock [58](#)
- 7** Steering wheel buttons, right
 Resuming cruise control [98](#)
 Storing the speed and accelerating or slowing down [98](#)
 Activating/deactivating cruise control [97](#)
- Steering wheel buttons, left
 Volume
 Bluetooth hands-free system [178](#)
 Bluetooth mobile phone preparation package [188](#)
 Activate/deactivate the voice activation system [24](#)
 Change the radio station
 Select a music track
 Scroll through the redial list
- 8** Horn, total area
- 9** Adjust the steering wheel [52](#)
- 10** Releasing the hood [231](#)

DISPLAYS

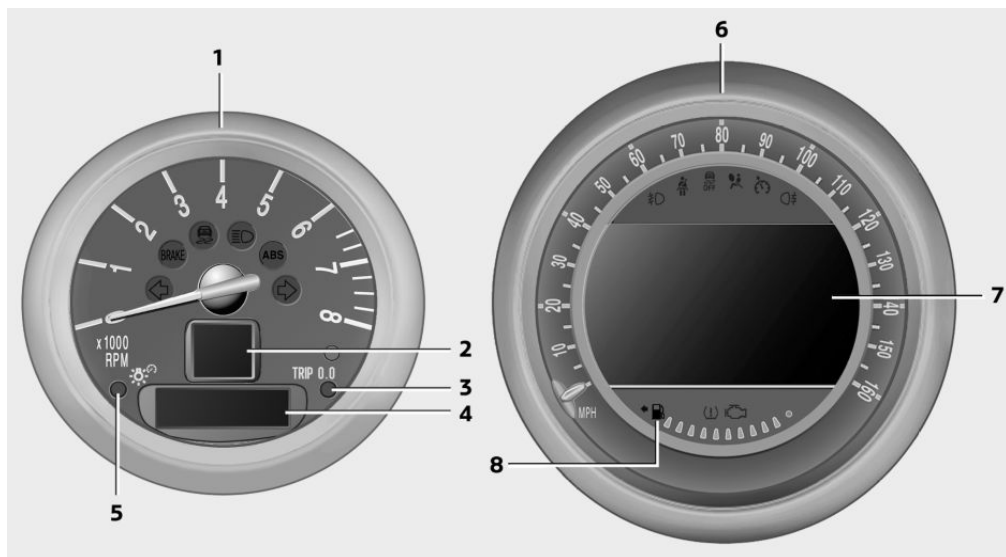

- | | |
|--|---|
| <p>1 Tachometer 69
with indicator and warning lights 15</p> <p>2 Display for</p> <ul style="list-style-type: none"> ▷ Current speed 68 ▷ Indicator/warning lights 15 <p>3 Resetting the trip odometer 68</p> <p>4 Display for</p> <ul style="list-style-type: none"> ▷ Steptronic transmission position 65 ▷ On-board computer 69 ▷ Service requirements 74 | <ul style="list-style-type: none"> ▷ Odometer and trip odometer 68 ▷ Flat Tire Monitor 85 ▷ Tire Pressure Monitor 87 ▷ Settings and information 71 ▷ Personal Profile settings 31 <p>5 Instrument lighting 80</p> <p>6 Speedometer with indicator and warning lights 15</p> <p>7 Control Display 18</p> <p>8 Fuel gauge 69</p> |
|--|---|

INDICATOR/WARNING LIGHTS

The principle

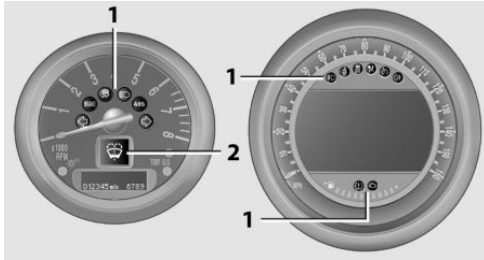

The indicator and warning lights can light up in a variety of combinations and colors in display area 1 or 2.

Several of the lights are checked for proper functioning when the engine is started or the ignition is switched on, and light up briefly.

Text messages

Text messages at the upper edge of the Control Display explain the meaning of the displayed indicator and warning lights.









Supplementary text messages

You can call up additional information, e.g., on the cause of a malfunction and on how to respond, via Check Control, refer to page 75.

In urgent cases, this information will be shown as soon as the corresponding light comes on.





Indicator lights without text messages

The following indicator lamps notify you that certain functions are active:

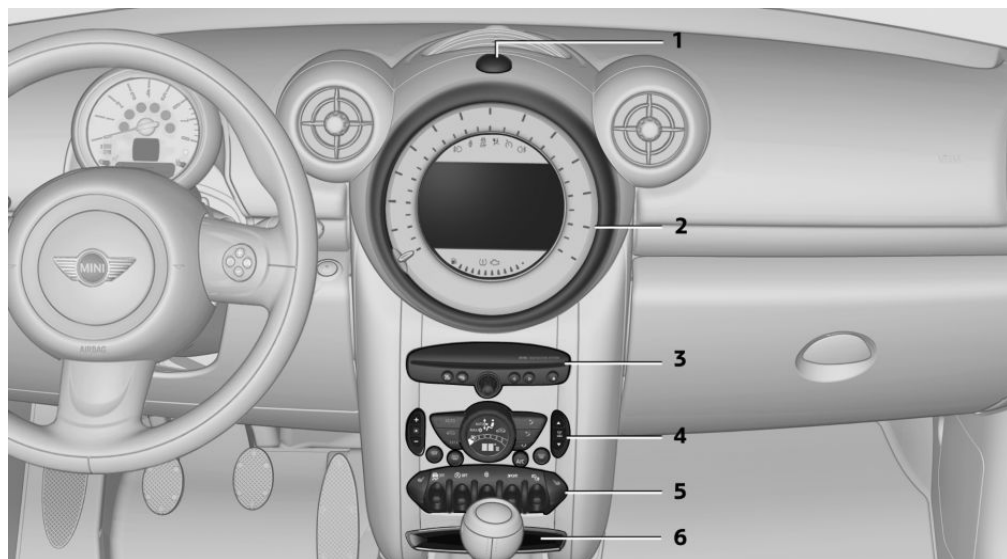
Symbol	Function or system
	Turn signal, refer to page 61
	
	High-beams/headlight flasher, refer to page 61
	Front fog lights, refer to page 80
	DSC or DTC is regulating the propulsive forces in order to maintain driving stability, refer to page 93
	The parking brake is set, refer to page 60
	Engine malfunction with adverse effect on emissions, refer to page 237
	Cruise control, refer to page 97





ALL AROUND THE CENTER CONSOLE

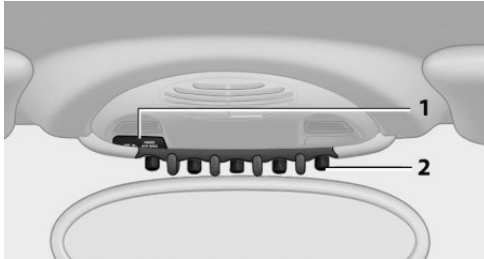

- 1 Hazard warning system
 - 2 Speedometer with Control Display 14
 - 3 Radio 156
CD/multimedia 156
 - 4 Air conditioning, automatic climate control 100
 - 5 Buttons on the center console
 -  Seat heating 46
 -  Central locking, inside 34
 - 6 Storage compartment
-  Front fog lamps 80
 -  Sport button 95
 -  Driving stability control systems
DSC Dynamic Stability Control 93
DTC Dynamic Traction Control 94

ALL AROUND THE ROOFLINER



- 1 Indicator/warning lights for the front passenger airbags [84](#)
- 2  Reading lights [81](#)
-  Ambient lighting color [81](#)
-  Glass sunroof, electrical [40](#)
-  Interior lights [81](#)

ALL AROUND THE SHIFT/SELECTOR LEVER

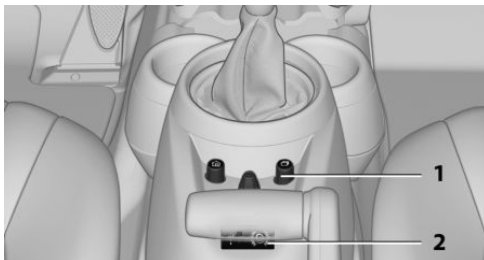

- 1 MINI joystick with buttons [19](#)
- 2 USB audio interface [168](#)

ONBOARD MONITOR

VEHICLE FEATURES AND OPTIONS

This chapter describes all standard, country-specific and optional features offered with the series. It also describes features that are not necessarily available in your car, e. g., due to the selected options or country versions. This also applies to safety-related functions and systems.

When using the features and systems described here, adhere to local regulations.

THE CONCEPT

The onboard monitor combines the functions of a large number of different switches. Thus, these functions can be operated from a central location.

WARNING

Operating the integrated information system and communication devices while driving can distract from traffic. It is possible to lose control of the vehicle. There is risk of an accident. Only use the systems or devices when the traffic situation allows. If necessary stop and use the systems and devices while the vehicle is stationary. ◀

CONTROL ELEMENTS AT A GLANCE

Control elements

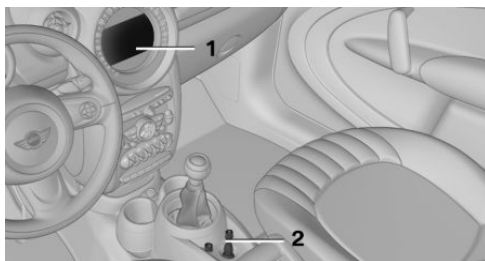

- 1 Control Display
- 2 MINI joystick with buttons

The buttons can be used to open the menus directly. The MINI joystick can be used to select menu items and create settings.

Control Display

Information

- ▷ To clean the Control Display, follow the care instructions, refer to page 257.
- ▷ Do not place objects close to the Control Display; otherwise, the Control Display can be damaged.

Switch off

1. Move the MINI joystick repeatedly to the right until the "Options" menu appears.

2. "Switch off control display"

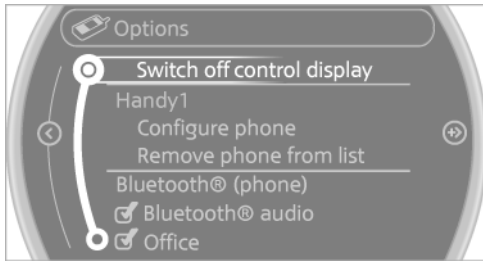

Switching on

Press the MINI joystick to switch on.

MINI joystick with buttons

Select menu items and create settings.

1. Turn, arrow 1.

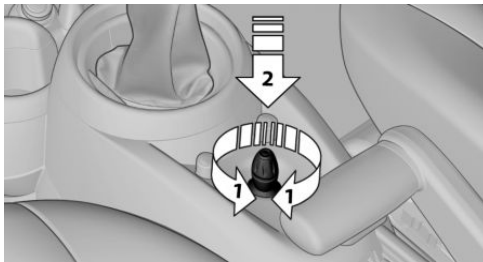

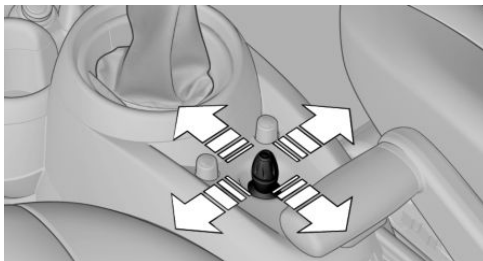

2. Press, arrow 2.

3. Move in four directions.



Buttons on the MINI joystick

Press button	Function
	Open the main menu.
	Changes to another menu.

OPERATING CONCEPT

Start screen

In the radio ready state and higher, the following message appears on the Control Display:

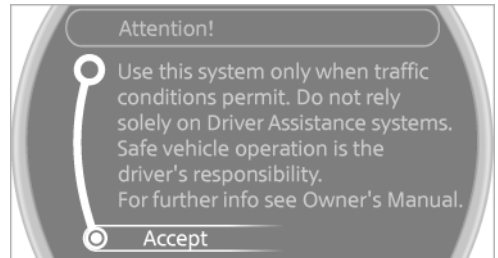

To hide the message: press the MINI joystick. The main menu is displayed.

The message is automatically hidden after approx. 10 seconds.

Opening the main menu

 Press the button.

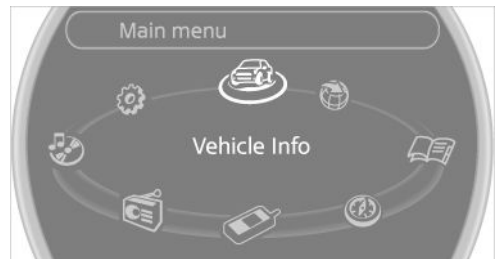

The main menu is displayed.

All onboard monitor functions can be called up via the main menu.

Selecting menu items

Menu items shown in white can be selected.

1. Turn the MINI joystick until the desired menu item is highlighted.

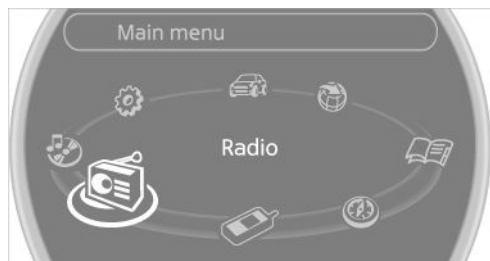

2. Press the MINI joystick.

A new menu is displayed or the function is performed.

With the button on the MINI joystick:



Press the button.

The menu items of the main menu can be opened consecutively by pressing the button repeatedly.

Menu items in the Owner's Manual

In the Owner's Manual, menu items that can be selected are set in quotation marks, e.g., "Settings".

Changing between panels

After a menu item is selected, e.g., "Radio", a new panel is displayed. Panels can overlap.

- ▷ Move the MINI joystick to the left.
 - The current panel is closed and the previous panel is displayed.
- ▷ Move the MINI joystick to the right.
 - A new panel is opened on top of the previous display.

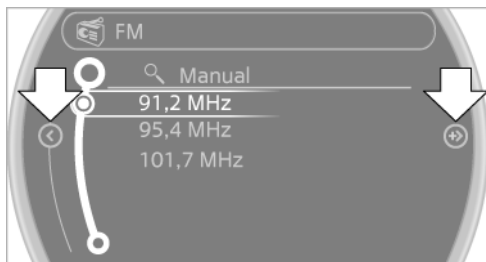

White arrows pointing to the left or right indicate that additional panels can be opened.

View of an opened menu

When a menu is opened, it generally opens with the panel that was last selected in that menu. To display the first panel of a menu:

Move the MINI joystick to the left repeatedly until the first panel is displayed.

Opening the Options menu

Move the MINI joystick repeatedly to the right until the "Options" menu appears.

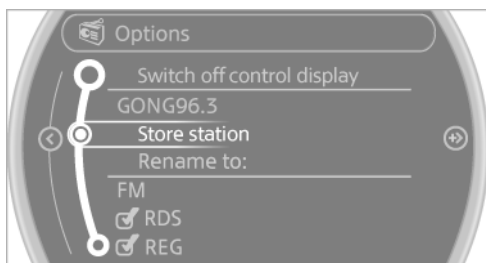

Options menu

The "Options" menu consists of various areas:

- ▷ Screen settings, e.g., "Switch off control display".
- ▷ Control options for the selected main menu, e.g., for "Radio".
- ▷ If applicable, further operating options for the selected menu, for instance "Store station".

Changing settings

1. Select a field.
2. Turn the MINI joystick until the desired setting is displayed.

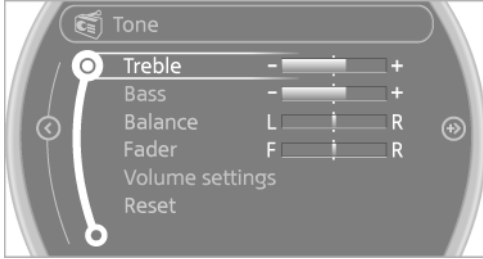

3. Press the MINI joystick to confirm the setting.

Activating/deactivating the functions

Several menu items are preceded by a checkbox. It indicates whether the function is activated or deactivated. Selecting the menu item activates or deactivates the function.

- Function is activated.
- The function is deactivated.

EXAMPLE: SETTING THE CLOCK

Setting the clock

1.  Press the button. The main menu is displayed.
2. Turn the MINI joystick until "Settings" is highlighted and press the MINI joystick.

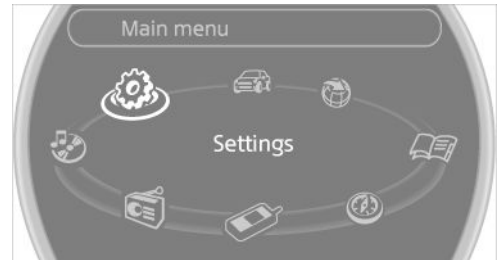

3. If necessary, move the MINI joystick to the left to display "Time/Date".
4. Turn the MINI joystick until "Time/Date" is highlighted and press the MINI joystick.

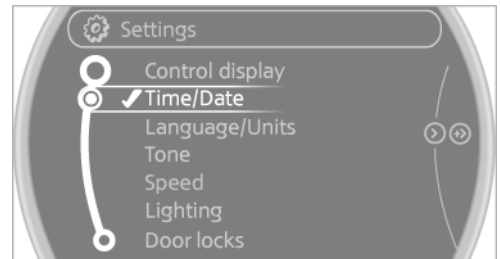

5. Turn the MINI joystick to set the hours and press the MINI joystick.
6. Turn the MINI joystick to set the minutes and press the MINI joystick.

STATUS INFORMATION

Status field

The following information is displayed in the status field at the top right:



- ▷ Time.
- ▷ Current entertainment source.
- ▷ Sound output, on/off.
- ▷ Wireless network reception strength.
- ▷ Telephone status.
- ▷ Traffic bulletin reception.

Check Control messages and entries using the voice activation system temporarily hide the status information.







Status field symbols

The symbols are grouped into various categories.



Radio symbols



Symbol	Meaning
	HD Radio™ is switched on.
	Satellite radio is switched on.

Telephone symbols

Symbol	Meaning
	Incoming or outgoing call.
	Wireless network reception strength Symbol flashes: searching for network.
	Wireless network is not available.
	Bluetooth is switched on.
	Roaming is active.
	Text message, e-mail was received.

Entertainment symbols

Symbol	Meaning
	CD player.
	AUX-IN port.

Symbol	Meaning
	USB audio interface.
	Music interface for smartphones.

Additional symbols



Symbol	Meaning
	Spoken instructions are switched off.

ENTERING LETTERS AND NUMBERS

General information

1. Turn the MINI joystick: select letters or numbers.
2. Select additional letters or numbers if needed.
3. "OK": confirm the entry.



Symbol	Function
	Press the MINI joystick: delete the letter or number.
	Press the MINI joystick for an extended period: delete all letters or numbers.
	Enter a blank space.

Switching between letters and numbers

Depending on the menu, you can switch between entering letters and numbers.

Symbol	Function
A^BC	Enter the letters.
1@+	Enter the numbers.

Switching between upper and lower case letters

Depending on the menu, you can switch between entering uppercase and lowercase letters.

Symbol	Function
▲ abc	Move the MINI joystick forward: switch from upper to lower case letters.
▲ ABC	Move the MINI joystick forward: switch from lower to upper case letters.

Entry comparison

Entering names and addresses: choice is narrowed down with every letter entered and letters may be added automatically.

Entries are continuously compared with data stored in the vehicle.

- ▷ Only those letters are offered during input for which data is available.
- ▷ Target search: names of locations may be entered in languages available through Control Display.

VOICE ACTIVATION SYSTEM

VEHICLE FEATURES AND OPTIONS

This chapter describes all standard, country-specific and optional features offered with the series. It also describes features that are not necessarily available in your car, e. g., due to the selected options or country versions. This also applies to safety-related functions and systems.

When using the features and systems described here, adhere to local regulations.

THE CONCEPT

- ▷ Most functions that are displayed on the Control Display can be operated with the voice activation system using spoken commands. The system prompts you to make your entries.
- ▷ Functions that can only be used when the vehicle is stationary cannot be operated using the voice activation system.
- ▷ The system uses a special microphone in the headliner on the driver's side.
- ▷ ›...‹ Verbal instructions in the Owner's Manual to use with the voice activation system.



REQUIREMENTS

Via the Control Display, set a language that is also supported by the voice activation system so that the spoken commands can be identified.

Set the language, refer to page [73](#).

USING VOICE ACTIVATION

Activating the voice activation system

1.  Press the button on the steering wheel.
2. Wait for the signal.
 -  This symbol on the Control Display indicates that the voice activation system is active.



3. Say the command.
 - The command appears on the Control Display.

If no other commands are available, operate the function via the onboard monitor in this case.

Terminating the voice activation system

-  Briefly press the button on the steering wheel or ›Cancel‹.

POSSIBLE COMMANDS

Most menu items on the Control Display can be voiced as commands.

The available commands depend on the menu that is currently displayed on the Control Display.

The functions of the main menu have short commands.

Some list items, such as the phone book entries, can also be selected via the voice activation system. Say the list items exactly as they are displayed on the list.

Having possible commands read aloud

You can have the system read possible commands aloud: ›Voice commands‹.

For example, if the "CD" menu is displayed, the commands for the operating the CD player are read out loud.

Executing functions using short commands

Functions on the main menu can be performed directly by means of short commands, usually irrespective of which menu item is currently selected, for instance ›Vehicle status‹.

List of short commands of the voice activation system, refer to page 264.

Help dialog for the voice activation system

Calling up help dialog: ›Help‹



Additional commands for the help dialog:

- ▶ ›Help with examples‹: information about the current operating options and the most important commands for them are announced.
- ▶ ›Help with voice activation‹: information about the principle of operation for the voice activation system is announced.

EXAMPLE: PLAYING BACK A CD

Via the main menu

The commands of the menu items are spoken out loud, in the same way as they are selected via the MINI joystick.

1. Switch on the Entertainment sound output if necessary.
2.  Press the button on the steering wheel.
3. ›C D and multimedia‹
The medium last played is played back.
4. ›C D‹
5. ›C D drive‹
The CD is played back.
6.  Press the button on the steering wheel again to select a specific track.
7. ›Track ...‹ e.g., CD track 4.

Via short commands

Playback of the CD can also be started using a short command.

1. Switch on the Entertainment sound output if necessary.
2.  Press the button on the steering wheel.
3. ›C D drive Track ...‹ e.g., CD track 4.

SETTING THE VOICE DIALOG

You can set whether the system should use the standard dialog or a shorter version.

In the shorter variant of the voice dialog, the announcements from the system are issued in an abbreviated form.

On the Control Display:

1. "Settings"
2. "Language/Units"
3. "Speech mode:"
4. Select the setting.

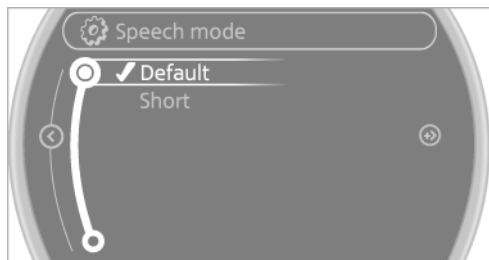

- ▷ Always say commands in the language of the voice activation system.
- ▷ Avoid making other noise in the vehicle while speaking.

ADJUSTING THE VOLUME

Turn the volume button during the spoken instructions until the desired volume is set.

- ▷ The volume remains constant even if the volume of other audio sources is changed.
- ▷ The volume is stored for the remote control currently in use.

NOTES ON EMERGENCY REQUESTS

Do not use the voice activation system to initiate an Emergency Request. In stressful situations, the voice and vocal pitch can change. This can unnecessarily delay the establishment of a telephone connection.

ENVIRONMENTAL CONDITIONS

- ▷ Say the commands, numbers, and letters smoothly and with normal volume, emphasis, and speed.



HANDLE ME.

AT A GLANCE

CONTROLS

DRIVING TIPS

NAVIGATION

ENTERTAINMENT

COMMUNICATION

MOBILITY

REFERENCE

OPENING AND CLOSING

VEHICLE FEATURES AND OPTIONS

This chapter describes all standard, country-specific and optional features offered with the series. It also describes features that are not necessarily available in your car, e. g., due to the selected options or country versions. This also applies to safety-related functions and systems.

When using the features and systems described here, adhere to local regulations.

REMOTE CONTROL/KEY

Buttons on the remote control

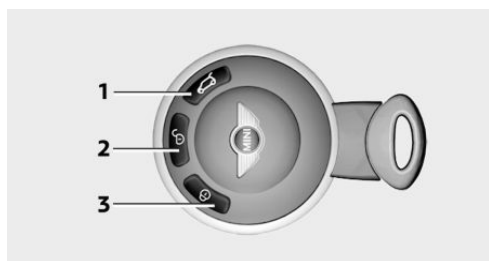

- 1 Opening tailgate
- 2 Unlocking
- 3 Locking

General information

Each remote control contains a rechargeable battery that is automatically recharged when it is in the ignition lock while the car is being driven. Use each remote control at least twice a year for longer road trips in order to maintain the batteries' charge status.

In vehicles equipped with Comfort Access, the remote control contains a replaceable battery, refer to page 39.

The settings called up and implemented when the vehicle is unlocked depend on which remote control is used to unlock the vehicle, Personal Profile, refer to page 31.

In addition, information about service requirements is stored in the remote control, Service data in the remote control, refer to page 236.

Integrated key

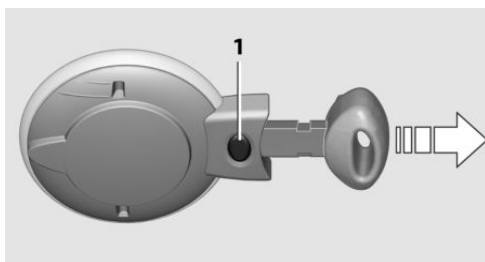

Press button 1 to unlock the key.

The integrated key fits the following locks:

- ▷ Driver's door, refer to page 34.

New remote controls

New remote controls are available from a dealer's service center or another qualified service center or repair shop.

Loss of the remote controls

A lost remote control can be blocked by a dealer's service center or another qualified service center or repair shop.

PERSONAL PROFILE

The concept

You can set several of your vehicle's functions to suit your personal needs and preferences.

- ▷ Through Personal Profile, most of these settings are stored for the remote control currently in use.
- ▷ While the vehicle is being unlocked, the remote control is recognized and the settings stored with it are called up and implemented.
- ▷ Your personal settings will be recognized and called up again even if the vehicle has been used in the meantime by someone else with another remote control.
- ▷ The individual settings are stored for no more than three remote controls.

Personal Profile settings

The following functions and settings can be stored in a profile.

More information on the settings can be found under:

- ▷ Response of the central locking system when the car is being unlocked, refer to page 32.
- ▷ Automatic locking of the vehicle, refer to page 35.
- ▷ Triple turn signal activation, refer to page 61.
- ▷ Settings for the displays on the onboard monitor, in the speedometer, and in the tachometer:
 - ▷ 12h/24h clock format, refer to page 72.
 - ▷ Date format, refer to page 73.
 - ▷ Brightness of the Control Display, refer to page 74.
 - ▷ Language on the Control Display, refer to page 73.

- ▷ Units of measure for fuel consumption, distance covered/remaining distances, and temperature, refer to page 72.
- ▷ Light settings:
 - ▷ Headlight courtesy delay feature, refer to page 79.
 - ▷ Daytime running lights, refer to page 79.
- ▷ Automatic climate control, refer to page 102: AUTO program, activating/deactivating the cooling function, setting the temperature, air volume, and air distribution.
- ▷ Entertainment:
 - ▷ Tone settings, refer to page 154.
 - ▷ Volume, refer to page 154.

CENTRAL LOCKING SYSTEM

The concept

The central locking system becomes active when the driver's door is closed.

The system simultaneously engages and releases the locks on the following:

- ▷ Doors.
- ▷ Tailgate.
- ▷ Fuel filler flap.

Operating from the outside

- ▷ Via the remote control.
- ▷ Via the door lock.
- ▷ In cars with Comfort Access, via the door handles on the driver's and front passenger sides.

The following takes place simultaneously when locking/unlocking the vehicle via the remote control:

- ▷ Depending on the vehicle equipment, the anti-theft protection is switched on and off as well. The anti-theft protection makes it

impossible to unlock the doors using the lock buttons or door handles.

- ▷ The welcome lamps, interior lamps, and ambient lighting are switched on and off.
- ▷ The alarm system is armed or disarmed, refer to page 39.

Operating from the inside

Via the switch/button for the central locking system, refer to page 34.

In an accident of the necessary severity, the central locking system unlocks automatically.

The hazard warning system and interior lamps come on.

OPENING AND CLOSING: FROM THE OUTSIDE

Using the remote control

General information

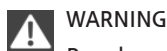

WARNING

People or animals in the vehicle can lock the doors from the inside and lock themselves in. The vehicle can then not be opened from the outside. There is risk of injuries. Take the remote control along so that the vehicle can be opened from the outside. ◀

Unlocking

 Press the button. The vehicle is unlocked.

The welcome lamps and interior lamps are switched on.

You can set how the vehicle is to be unlocked.

Settings are stored for the remote control currently in use.

1. "Settings"



2. "Door locks"

3. "Unlock button"

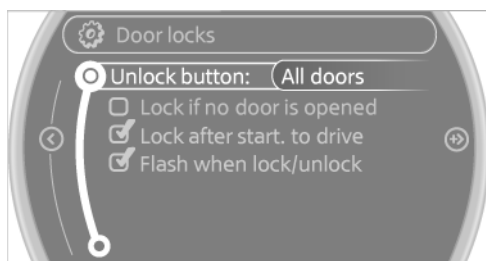

4. Select the desired function:

- ▷ "All doors"

 Press the button once: the entire vehicle unlocks.

- ▷ "Driver's door only"

 Pressing the button once unlocks only the driver's door and the fuel filler flap. Pressing twice unlocks the entire vehicle.

Convenient opening

 Press and hold the button on the remote control.

The power windows are opened. Depending on the vehicle equipment, the glass sunroof is raised.

Convenient closing with the remote control is not possible.

Locking

 Press the button.

 **WARNING**
Unlocking from the inside is only possible with special knowledge.

If people must spend a longer time in the vehicle while it is very hot or cold outside, there is risk of injuries or danger to life. Do not lock the vehicle from the outside when there are people in it. ◀

Setting the confirmation signals

Have unlocking or locking of the vehicle confirmed.

1. "Settings"
2. "Door locks"
3. "Flash when lock/unlock"

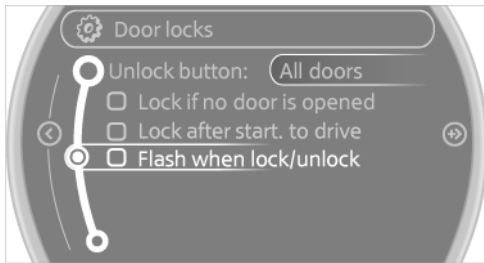

4. Press the MINI joystick.

Switching on the interior lamps

When the vehicle is locked:

 Press the button.

You can also use this function to locate your vehicle in parking garages, etc.

Unlocking the tailgate

 Press the button for approx. 1 second and then release it.

Malfunctions

The function of the remote control may be impaired by local radio waves. If this occurs, unlock and lock the vehicle at the door lock with the integrated key.

If it should become impossible to lock the vehicle with a remote control, the battery in the remote control is discharged. Use this remote control on an extended trip to recharge the battery, refer to page 30.

For US owners only

The transmitter and receiver units comply with part 15 of the FCC/Federal Communication Commission regulations. Operation is governed by the following:

FCC ID:
LX87665

LX8766E

LX8CAS

Compliance statement:

This device complies with part 15 of the FCC Rules. Operation is subject to the following two conditions:

- ▶ This device may not cause harmful interference, and
- ▶ this device must accept any interference received, including interference that may cause undesired operation.

Any unauthorized modifications or changes to these devices could void the user's authority to operate this equipment.

Using the door lock

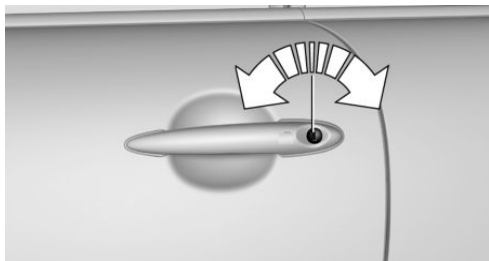

Sets how the vehicle is to be unlocked, refer to page 32.

In some vehicle equipment versions, only the driver's door can be unlocked and locked via the door lock.



WARNING

Unlocking from the inside is only possible with special knowledge.

If people must spend a longer time in the vehicle while it is very hot or cold outside, there is risk of injuries or danger to life. Do not lock the vehicle from the outside when there are people in it. ◀

Unlocking the doors and tailgate at once

To lock all doors, the fuel filler flap, and the tailgate at once:

1. With the doors closed, lock the vehicle using the button for the central locking system in the interior, refer to page 34.
2. Unlock and open the driver's or front passenger door, refer to page 35.
3. To lock the vehicle:
 - ▷ Lock the driver's door using the integrated key in the door lock, or
 - ▷ Press down the lock button of the front passenger door and close the door from the outside.

Convenient opening and closing

In vehicles with an alarm system or Comfort Access, the windows and the glass sunroof can be operated via the door lock.

Opening/closing

Turn the key to the unlock or lock position and hold it there.



WARNING

With convenient closing, body parts can be jammed. There is risk of injuries. Make sure that the area of movement of the doors is clear during convenient closing. ◀

Manual operation

If an electrical malfunction occurs, the driver's door can be unlocked or locked by turning the integrated key to the end positions of the door lock.

OPENING AND CLOSING: FROM THE INSIDE

Operation via

- ▷ Switch in the center console:

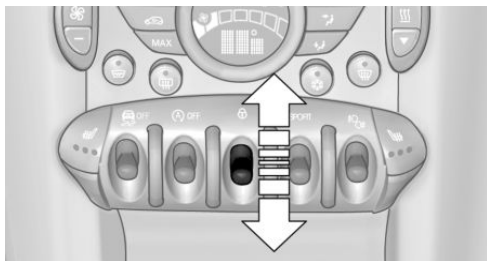

- ▷ Button in the driver's or front passenger door:

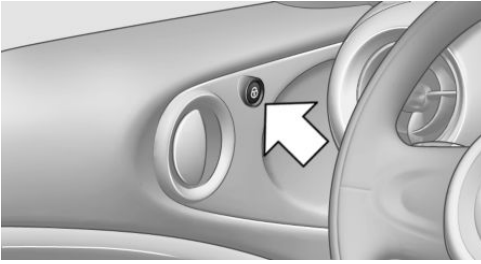

The graphic shows the button in the MINI Pace-man as an example.

The switch or the buttons can be used to lock or unlock the doors and tailgate when the doors are closed, but they are not theft-protected. The fuel filler flap remains unlocked.

Unlocking and opening doors

- ▶ Using the switch or the buttons for the central locking system, unlock all of the doors at once and then pull the door opener above the armrest, or
- ▶ Pull the door handle on each door twice: the door is unlocked the first time and opened the second time.

Locking

- ▶ Press the switch/button or
- ▶ Push down the lock button of a door. To avoid locking yourself out by accident, the driver's door cannot be locked at the lock button while the door is open.

Automatic locking

In addition, it is possible to set the situations in which the vehicle locks. The setting is stored for the remote control in use.

1. "Settings"
2. "Door locks"
3. Select a menu item:
 - ▶ "Lock if no door is opened"

The central locking system locks after a short period if no door is opened.

- ▶ "Lock after start. to drive"

The central locking system locks when you start driving.

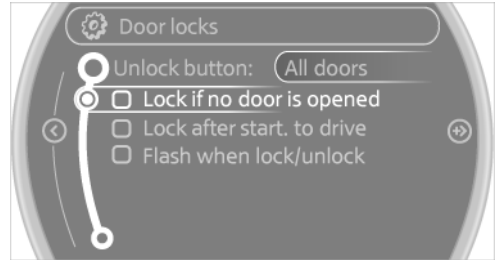

⚠ WARNING

People or animals in the vehicle can lock the doors from the inside and lock themselves in. The vehicle can then not be opened from the outside. There is risk of injuries. Take the remote control along so that the vehicle can be opened from the outside. ◀

TAILGATE

Opening

The tailgate pivots back and up when it opens. Ensure that adequate clearance is available before opening.

⚠ CAUTION

Sharp-edged or pointed objects can hit the rear window and heat conductors while driving. There is risk of property damage. Cover the edges and ensure that pointed objects do not hit the rear window. ◀

Only drive with the tailgate fully closed; otherwise, the tail lamps will be hidden from view and driving safety will be compromised.

In some market-specific versions, the tailgate can only be unlocked using the remote control if the vehicle was unlocked first.

Opening from the inside

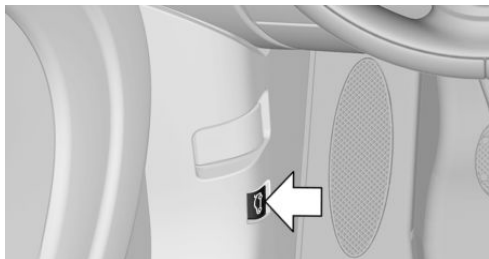

Press the button on the driver's footwell.

MINI Countryman



Press the top half of the MINI emblem, arrow, or

 Press the button on the remote control for approx. 1 second and release. The tailgate is unlocked.

MINI Paceman



Press the top half of the MINI emblem, arrow, or

 Press the button on the remote control for approx. 1 second and release. The tailgate is unlocked.

Closing

 **WARNING**
Body parts can be jammed when operating the tailgate. There is risk of injuries. Make sure that the area of movement of the tailgate is clear during opening and closing. ◀

Make sure that the cargo cover rests on the rubber buffers of the securing straps when closing the tailgate.

MINI Countryman



Recessed grips on the inside trim of the tailgate can be used to conveniently pull down the tailgate.

MINI Paceman



Recessed grips on the inside trim of the tailgate can be used to conveniently pull down the tailgate.

COMFORT ACCESS

The concept

The vehicle can be accessed without activating the remote control. All you need to do is to have the remote control with you, e.g., in your jacket pocket. The vehicle automatically detects the remote control when it is nearby or in the passenger compartment.

Comfort Access supports the following functions:

- ▶ Unlocking/locking of the vehicle.
- ▶ Unlocking of the tailgate separately.
- ▶ Starting the engine.

Functional requirements

- ▶ There are no external sources of interference in the vicinity.
- ▶ To lock the vehicle, the remote control must be located outside of the vehicle.
- ▶ The next unlocking and locking cycle is not possible until after approx. 2 seconds.
- ▶ The engine can only be started if the remote control is inside the vehicle.
- ▶ The doors and tailgate must be closed to operate the windows.

Comparison with ordinary remote control

The functions can be controlled by pressing the buttons or via Comfort Access.

Notes on opening and closing, refer to page 30.

If you notice a brief delay while opening or closing the windows or glass sunroof, the system is checking whether a remote control is inside the vehicle. Repeat the opening or closing procedure, if necessary.

Unlocking



Press button 1.

Depending on the setting, either only the driver's door or the entire vehicle is unlocked, refer to page 32.

Pressing the button again locks the entire vehicle again.

Convenient opening with the remote control, refer to page 32.

Locking

Press button 1.

For Convenient closing, press and hold button 1.

The windows and, if applicable, the glass sunroof are closed in addition.

Unlocking the tailgate separately

Press the top half of the MINI emblem.

This corresponds to pressing the following button on the remote control:



If a remote control accidentally left in the cargo area is detected in the locked vehicle after the tailgate is closed, the tailgate opens again slightly. The hazard warning system flashes and an acoustic signal sounds.

Power windows and electrical glass sunroof

When the engine is switched off, the windows and the sunroof can be operated as long as neither the doors nor the tailgate are opened.

When the door and tailgate are closed again and the remote control is detected inside the vehicle, the windows and the sunroof can be operated again.

Insert the remote control into the ignition lock to be able to operate the windows and the sunroof while the engine is switched off and the doors are open.

Switching on the radio ready state

Press the Start/Stop button to switch on the radio ready state, refer to page 58.

Do not depress the brake or the clutch; otherwise, the engine will start.

Starting the engine

The engine can be started or the ignition can be switched on, refer to page 58, when a remote control is inside the vehicle. It is not necessary to insert a remote control into the ignition lock.

Switching off the engine in cars with Steptronic transmission

The engine can only be switched off with the selector lever in position P, refer to page 65.

To switch off the engine with the selector lever in position N, the remote control must be inserted in the ignition lock.

Before driving a vehicle with Steptronic transmission into a car wash

1. Insert the remote control into the ignition switch.
2. Depress the brake pedal.
3. Move the selector lever to position N.
4. Switch the engine off.

The vehicle can roll.

Malfunction

The Comfort Access functions can be disturbed by local radio waves, such as by a mobile phone in the immediate vicinity of the remote

control or when a mobile phone is being charged in the vehicle.

If this occurs, open or close the vehicle using the buttons on the remote control or use the integrated key in the door lock.

To start the engine afterward, insert the remote control into the ignition switch.

Warning lights



The warning light in the instrument cluster lights up when you attempt to start the engine: the engine cannot be started.

The remote control is not in the vehicle or has a malfunction. Take the remote control with you inside the vehicle or have it checked. If necessary, insert another remote control into the ignition switch.



The warning lamp in the instrument cluster lights up while the engine is running: the remote control is no longer inside the vehicle.

After switching off the engine, the engine can only be started again within approx. 10 seconds if no door has been opened.



The indicator lamp lights up and a message appears on the Control Display: replace the remote control battery.

Replacing the battery

The remote control for Comfort Access contains a battery that will need to be replaced from time to time.

1. Remove the cover.

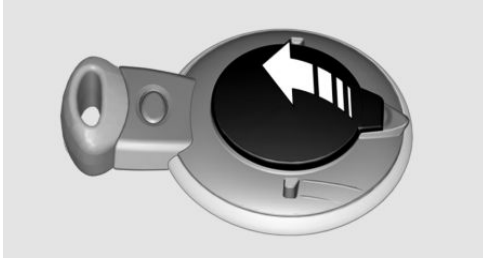

2. Insert a new battery with the positive side facing upwards.
3. Press the cover closed.

 Take the old battery to a collection point, a dealer's service center or another qualified service center or repair shop.

ALARM SYSTEM

The concept

The enabled alarm system reacts to the following:

- ▶ Opening of a door, the hood or the tailgate.
- ▶ Movements inside the vehicle.
- ▶ Changes in the vehicle tilt, e.g., during attempts to steal a wheel or tow the car.
- ▶ Interruptions in battery voltage.

Depending on the market-specific version, the alarm system briefly signals unauthorized entry attempts by:

- ▶ By sounding an acoustic alarm.
- ▶ By switching on the hazard warning system.

Arming and disarming the alarm system

General information

When the vehicle is locked and unlocked, the alarm system is armed and disarmed at the same time.

Door lock and armed alarm system

Unlocking via the door lock will trigger the alarm on some market-specific versions.

To stop this alarm, unlock the vehicle with the remote control or switch on the ignition.

Tailgate with armed alarm system

The tailgate, refer to page 33, can also be opened when the alarm system is armed.

 Press the button on the remote control.

When you subsequently close the tailgate, it is again locked and monitored.

Unlocking via the door lock will trigger the alarm on some market-specific versions.

Switching off the alarm

- ▶ Unlock the vehicle using the remote control, refer to page 32.
- ▶ Insert the remote control all the way into the ignition lock.
- ▶ With Comfort Access and if you are carrying the remote control with you, push the button on the door lock.

Display on the tachometer

When the alarm system is being armed, all LEDs pulse like a heartbeat. One LED flashes after approx. 16 minutes.

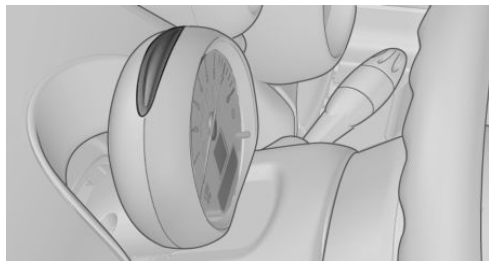

- ▷ LEDs pulse or LED flashes: system is armed.
- ▷ One LED flashes at short intervals: the doors, hood, or tailgate is not properly closed.
Even if these are not closed fully, the remaining items are locked and the LEDs pulse after approx. 10 seconds for approx. 16 minutes; afterwards, one LED flashes. The interior motion sensor is not activated.
- ▷ The LEDs go out after the vehicle is unlocked: the vehicle has not been tampered with in the meantime.
- ▷ The LEDs flash after the vehicle is unlocked until the remote control is inserted in the ignition, but for no longer than approx. 5 minutes: the vehicle has been tampered with in the meantime.

Panic mode

You can trigger the alarm system if you find yourself in a dangerous situation.

-  Press the button on the remote control for at least two seconds.

To switch off the alarm: press any button on the remote control.

Tilt alarm sensor

The tilt of the vehicle is monitored.

The alarm system responds in situations such as attempts to steal a wheel or tow the car.

Interior motion sensor

For the interior motion sensor to function properly, the windows and the glass sunroof must be closed.

Avoiding unintentional alarms

The tilt alarm sensor and interior motion sensor can be switched off together, such as in the following situations:

- ▷ In duplex garages.
- ▷ During transport on car-carrying trains, at sea or on a trailer.
- ▷ When animals are to remain in the vehicle.

Switching off the tilt alarm sensor and interior motion sensor

- ▷  Press the button on the remote control twice in succession.
- ▷ Lock the vehicle twice with the integrated key.

The LEDs flash in short succession for approx. 2 seconds. The tilt alarm sensor and interior motion sensor remain switched off until the vehicle is unlocked and locked again.

GLASS SUNROOF, ELECTRICAL

General information



WARNING

Body parts can be jammed on operating the glass sunroof. There is risk of injuries. Make sure that the area of movement of the glass sunroof is clear during opening and closing. ◀



WARNING

Unattended children or animals can move the vehicle and endanger themselves and traffic, e.g. with the following actions:

- ▷ Pressing the Start/Stop button.
- ▷ Releasing the parking brake.

- ▷ Opening and closing of doors or windows.
- ▷ Shifting the selector lever into neutral.
- ▷ Using vehicle equipment.

There is risk of accidents or injuries. Do not leave children or animals unattended in the vehicle. Carry remote control along when exiting and lock the vehicle. ◀

Convenient operation via:

- ▷ Door lock, refer to page 34
- ▷ Comfort Access, refer to page 37

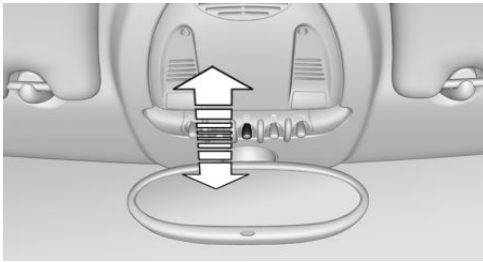

Tilting the glass sunroof

MINI Countryman:

- ▷ Press the switch back to the resistance point and hold.
Both glass sunroofs are raised.
Releasing stops the motion.
- ▷ With the ignition switched on, press the switch back past the resistance point.
Both closed glass sunroofs are raised fully.
Pressing again stops the motion.

MINI Paceman:

- ▷ Press the switch back to the resistance point and hold.
The front glass sunroof is raised.
Releasing stops the motion.
- ▷ With the ignition switched on, press the switch back past the resistance point.
The front glass sunroof is fully raised.
Pressing again stops the motion.

Opening, closing

MINI Countryman:

- ▷ In the raised position with the ignition switched on, press the switch back and hold.
The front glass sunroof is opened. The rear glass sunroof is closed.
Releasing stops the motion.

The same method is used to close the glass sunroof, in this case by pressing the switch forward.

The front glass sunroof remains in the raised position. The rear glass sunroof is raised. Pressing again closes both sunroofs completely.

MINI Paceman:

- ▷ In the raised position with the ignition switched on, press the switch back and hold.
The front glass sunroof is opened.
Releasing stops the motion.

The same method is used to close the glass sunroof, in this case by pressing the switch forward.

The front glass sunroof remains in the raised position. Pressing again closes the roof completely.

Roller sunblind

The roller sunblind can be opened and closed separately from the glass sunroof.

After a power failure

After a power failure, it could happen that the sunroof can only be raised. In this case, have the system initialized. The manufacturer of your MINI recommends that this work be performed by a dealer's service center or another qualified service center or repair shop.

POWER WINDOWS

General information

WARNING

When operating the windows, body parts and objects can be jammed. There is risk of injuries or risk of property damage. Make sure that the area of movement of the windows is clear during opening and closing. ◀

WARNING

Unattended children or animals can move the vehicle and endanger themselves and traffic, e.g. with the following actions:

- ▷ Pressing the Start/Stop button.
- ▷ Releasing the parking brake.
- ▷ Opening and closing of doors or windows.
- ▷ Shifting the selector lever into neutral.
- ▷ Using vehicle equipment.

There is risk of accidents or injuries. Do not leave children or animals unattended in the vehicle. Carry remote control along when exiting and lock the vehicle. ◀

If, after having been opened and closed a number of times in close succession, a window can only be closed, the system is overheated. Let the system cool down for several minutes with the ignition switched on or the engine running.

Opening, closing

Front windows



To open:

- ▷ Press the switch to the resistance point. The window opens while the switch is held.
- ▷ Press the switch beyond the resistance point. The window opens automatically in the radio ready state and higher.

Press again briefly to stop the opening procedure.

To close:

- ▷ Pull the switch to the resistance point. The window closes while the switch is held.
- ▷ Pull the switch beyond the resistance point. The window closes automatically.

Pressing the switch stops the motion.

MINI Countryman: rear windows



To open:

- ▷ Press the switch to the resistance point. The window opens while the switch is held.
- ▷ Press the switch beyond the resistance point. The window opens automatically in the radio ready state and higher.

To close:

- ▷ Pull the switch to the resistance point. The window closes while the switch is held.
- ▷ Pull the switch beyond the resistance point. The window closes automatically.

Pressing the switch stops the motion.

After the ignition is switched off

The windows can be operated for approx. 1 minute after the remote control is removed or the ignition is switched off.

Pinch protection system

If the closing force exceeds a specific value as a window closes, the closing action is interrupted.

The window reopens slightly.

WARNING

When operating the windows, body parts and objects can be jammed. There is risk of injuries or risk of property damage. Make sure that the area of movement of the windows is clear during opening and closing. ◀

WARNING

Accessories on the windows such as antennas can impact jam protection. There is risk of injuries. Do not install accessories in the area of movement of the windows. ◀

Closing without the pinch protection system

WARNING

When operating the windows, body parts and objects can be jammed. There is risk of injuries or risk of property damage. Make sure that the area of movement of the windows is clear during opening and closing. ◀

If there is an external danger or, for example, if ice on the windows prevents a window from closing normally, the window can be closed manually.

1. Pull the switch past the resistance point and hold it there. Pinch protection is limited and the window reopens slightly if the closing force exceeds a certain value.
2. Pull the switch past the resistance point again within approx. 4 seconds and hold it there.

The window closes without pinch protection.

MINI Countryman: safety switch



With the safety switch, the rear windows are prevented from being opened or closed via the switches in the rear passenger area, such as by children.

Press the button. The LED lights up if the safety function is switched on.

WARNING

When operating the windows, body parts and objects can be jammed. There is risk of injuries or risk of property damage. Make sure that the area of movement of the windows is clear during opening and closing. ◀

ADJUSTING

VEHICLE FEATURES AND OPTIONS

This chapter describes all standard, country-specific and optional features offered with the series. It also describes features that are not necessarily available in your car, e. g., due to the selected options or country versions. This also applies to safety-related functions and systems.

When using the features and systems described here, adhere to local regulations.

SITTING SAFELY

The ideal seating position can make a vital contribution to relaxed, fatigue-free driving.

The seating position plays an important role in an accident in combination with:

- ▷ Safety belts, refer to page 46
- ▷ Head restraints, refer to page 49.
- ▷ Airbags, refer to page 82.

SEATS

Note before adjusting

WARNING
Seat adjustments while driving can lead to unexpected movements of the seat. Vehicle control could be lost. There is risk of an accident. Only adjust the side on the driver's side when the vehicle is stationary. ◀

WARNING
With a backrest inclined too far to the rear, the protective effect of the safety belt cannot be ensured anymore. There is a danger of sliding under the safety belt in an accident.

There is risk of injuries or danger to life. Adjust the seat prior to starting the trip. Adjust the backrest in an as upright position as possible and do not adjust again while driving. ◀



WARNING

There is risk of jamming when moving the seats. There is risk of injuries or risk of property damage. Make sure that the area of movement of the seat is clear prior to any adjustment. ◀

Front seat adjustment

Forward/backward



Pull the lever, arrow 1, and slide the seat into the desired position, arrows 2.

After releasing the lever, move the seat forward or back slightly to make sure it engages properly.

Height

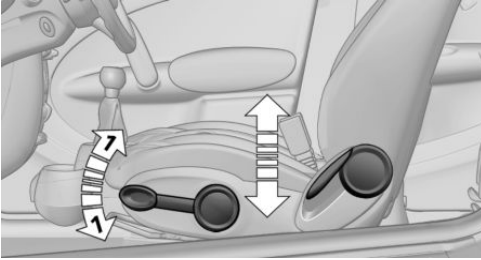

Pull the lever up or push it down repeatedly, arrows 1, until the desired height is reached, arrows 2.

Backrest

MINI Countryman:

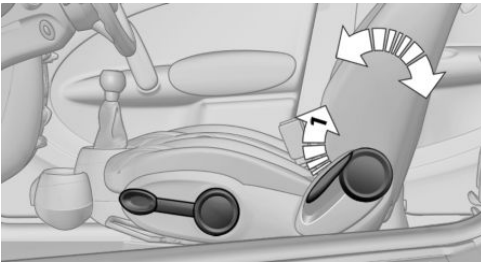

Pull the lever, arrow 1, and apply your weight to the backrest or lift it off, as necessary.

MINI Paceman:

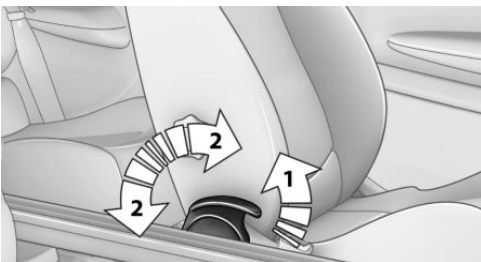

Pull the lever, arrow 1, and apply your weight to the backrest or lift it off, as necessary, arrows 2.

Lumbar support

You can also adjust the contour of the backrest to obtain additional support in the lumbar region.

The upper hips and spinal column receive supplementary support to help you maintain a relaxed, upright sitting position.

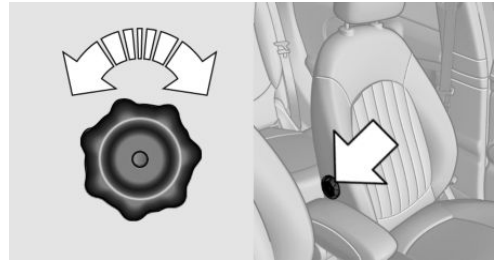

The graphic shows the MINI Countryman as an example.

Turn the wheel to increase or decrease the curvature.

MINI Countryman: rear seat adjustment

Forward/backward

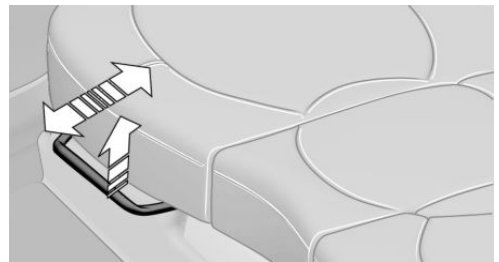

Pull the lever and slide the seat into the desired position.

Release the lever and move the seat slightly forward or back so that it engages properly.

Backrest

Adjust the backrest tilt, refer to page 111.

MINI Paceman: entry in the rear

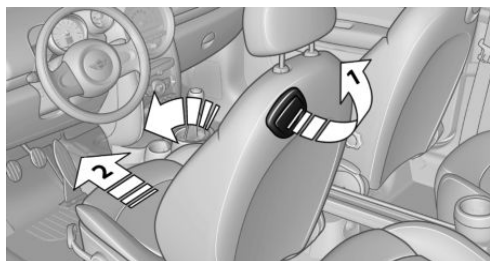

1. Pull the lever on the back of the seat upward, arrow 1.
The backrest folds forward.
2. Push against the backrest to move the seat forward, arrow 2.

To make it easier to enter the car in the rear, push back the safety belt on the lower belt guide rail if necessary.

Restoring the original seat position

The driver's seat has a mechanical memory function for the forward/backward seat setting and the backrest setting.

1. Push the seat back to the original position.
Do not fold back the backrest until the seat is in its original position; otherwise, the seat will engage in its current position. If this happens, adjust the forward/backward position manually, refer to page 44.
2. Fold back the backrest to lock the seat.

WARNING

There is risk of jamming when moving the seats. There is risk of injuries or risk of property damage. Make sure that the area of movement of the seat is clear prior to any adjustment. ◀

WARNING

Unexpected movements of the backrest while driving may occur due to an unlocked backrest. Vehicle control could be lost. There is risk of injuries. Fold back and lock the backrests before driving. ◀

Seat heating

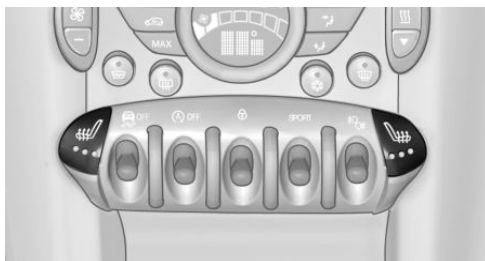

Switching on

The temperature setting progresses one step through its control sequence each time you press the button. The maximum temperature is reached when three LEDs are lit.

If the trip is continued within approx. 15 minutes, the seat heating is activated automatically with the temperature set last.

The temperature is reduced, if need be, down to no heat in order to reduce the load on the battery. The LEDs remain lit.

Switch off

Press the button longer.

SAFETY BELTS

Number of safety belts

Your vehicle has been fitted with four or five safety belts for the safety of you and your passengers.

However, they can only offer protection when adjusted correctly.

Information

Always make sure that safety belts are being worn by all occupants before driving away.

Although airbags enhance safety by providing added protection, they are not a substitute for safety belts.

The shoulder strap's anchorage point will be correct for adult seat occupants of every build if the seat is correctly adjusted.

WARNING

If the safety belt is used by more than one person, the protective effect of the safety belt cannot be ensured anymore. There is risk of injuries or danger to life. Do not allow more than one person to wear a single safety belt. Infants and children are not allowed in an occupant's lap, but must be transported and respectively secured in designated child restraint systems. ◀

WARNING

The protective effect of the safety belts can be limited or lost when safety belts are fastened incorrectly. An incorrectly fastened safety belt can cause additional injuries, e.g. in the event of an accident or during braking and evasive maneuvers. There is risk of injuries or danger to life. Make sure that all occupants are wearing safety belts correctly. ◀

WARNING

With a rear backrest that is not locked, the protective function of the middle safety belt is not guaranteed. There is risk of injuries or danger to life. If you are using the middle safety belt, lock the wider rear backrest. ◀

Correct use of safety belts

- ▷ Wear the belt twist-free and as tight to your body as possible over your lap and shoulders.
- ▷ Wear the belt deep on your hips over your lap. The belt may not press on your stomach.
- ▷ Do not wear the belt on your throat, rub it on sharp edges, guide it or jam it in across hard or fragile objects.
- ▷ Avoid thick clothing.
- ▷ Re-tighten the belt frequently upward around your upper body.

Buckling the belt

MINI Countryman:

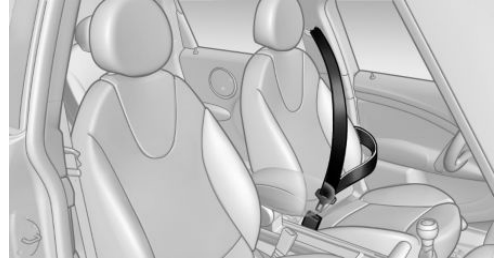

MINI Paceman:

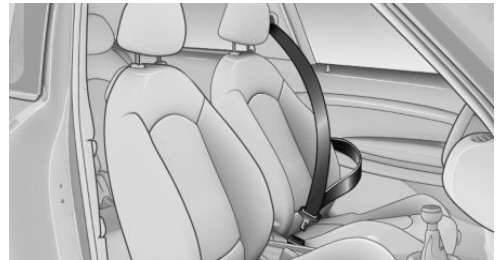

Make sure you hear the latch plate engage in the belt buckle.

The shoulder strap's anchorage point will be correct for adult seat occupants of every build if the seat is correctly adjusted, refer to page 44.

Unbuckling the belt

1. Hold the belt firmly.
2. Press the red button in the belt buckle.
3. Guide the belt back into its reel.

Securing the buckle tongues

If the front passenger seat is not occupied, slide the buckle tongue up to the belt stop knob with the clip.

When the outer rear seats are not occupied, the buckle tongues of the rear seats can be slid up to the cargo area trim with the clip.

This helps avoid annoying noises when driving.

MINI Countryman: center safety belt of rear seat

The belt buckle embossed with the word CENTER is intended exclusively for use by passengers riding in the center position.

If the center safety belt in the rear is used, the backrests must be locked, refer to page 112.

The safety belt will not have a restraining effect if the backrest is not locked.

Belt holder in the headliner

The holder for the safety belt is located in the headliner.



- 1 Opening for the safety belt
- 2 Holder for the small buckle tongue

Take the small buckle tongue out of the holder. Move both buckle tongues downward.

Closing

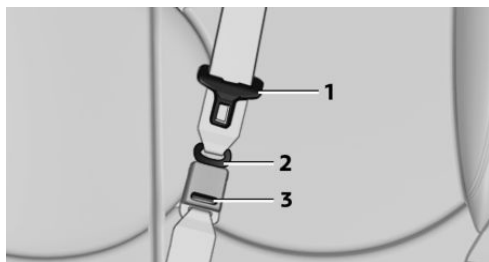

Insert the small buckle tongue 2 of the safety belt into the small belt buckle 3.

Opening

Press the red button on the small belt buckle 3 with buckle tongue 1.

When the center safety belt is locked:

Press the red button 3 with the buckle tongue of the outer left safety belt.

Putting on the belt

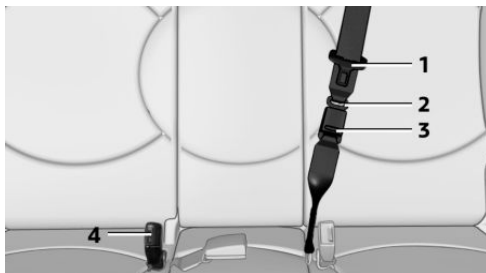

- 1 Large buckle tongue
- 2 Small buckle tongue
- 3 Small belt buckle
- 4 Large belt buckle

Buckle tongue 1 must be inserted in belt buckle 4. Make sure you hear the buckle tongue engage in the belt buckle.

Insert the buckle tongue into the belt buckle in such a way that the belt lies smoothly against the body of the buckled person and is not twisted.

Stowing the center safety belt

If the center seat is not occupied, insert the belt buckles 3 and 4 into the respective holders, arrows.

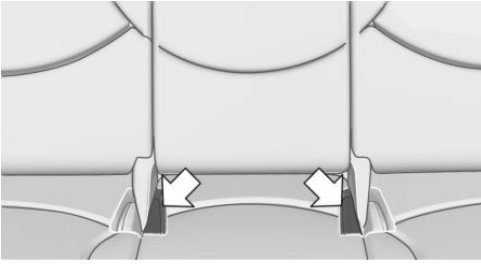

Move the buckle tongues to the belt holder on the headliner, refer to page 48, and insert them into the provided holders.

Safety belt reminder for driver's seat and front passenger seat



The indicator lamps light up and a signal sounds. In addition, a message appears on the Control Display. Check whether the safety belt has been fastened correctly.



Damage to safety belts

In the case of strain caused by accidents or damage:

Have the safety belts, including the safety belt tensioners, replaced and have the belt anchors checked.



WARNING

The protective effect of the safety belts may not be fully functional or fail in the following situations:

- ▷ Safety belts are damaged, soiled or changed in any other way.
- ▷ Safety belt buckle is damaged or heavily soiled.
- ▷ Belt tensioners or belt retractors were modified.

Safety belts can be imperceptibly damaged in the event of an accident. There is risk of injuries or danger to life. Do not modify safety belts, safety belt buckles, belt tensioners, belt retractors or belt anchors and keep them clean. After an accident, have the safety belts checked by a

dealer's service center or another qualified service center or repair shop. ◀

HEAD RESTRAINTS

Information



WARNING

A missing protective effect due to removed or not correctly adjusted head restraints can cause injuries in the head and neck area. There is risk of injuries. Install head restraints on occupied seats prior to driving and make sure that the center of the head restraint supports the back of the head at eye level. ◀



WARNING

Objects on the head restraint reduce the protective effect in the head and neck area. There is risk of injuries.

- ▷ Do not use seat or head restraint covers.
- ▷ Do not hang objects, e.g., clothes hangers, directly on the head restraint.
- ▷ Only use accessories that have been determined to be safe for attachment to a head restraint.
- ▷ Do not use any accessories, e.g. pillows, while driving. ◀

Correctly set head restraint

A correctly adjusted head restraint reduces the risk of spinal injury in the event of an accident.

Height

Adjust the head restraint so that its center is approx. at ear level.

MINI Countryman: the center rear head restraint is not height adjustable.

Height adjustment

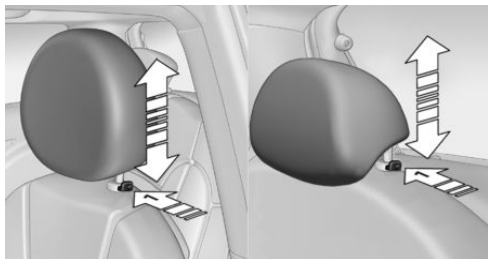

To raise: pull.

To lower: press the button, arrow 1, and push the head restraint down until it engages.

MINI Countryman: additionally press button 2 on the rear head restraints only if you wish to remove them.

Removing

Only remove the head restraint if no one will be sitting in the seat in question.

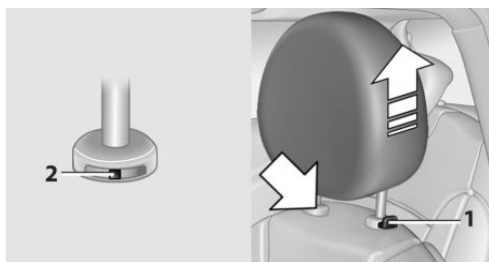

Front

1. Pull the head restraint upward as far as possible.
2. MINI Countryman: tilt the backrest back slightly.
MINI Paceman: fold the backrest forward if necessary.
3. Press button 1 and pull out the head restraint all the way to the stop.
MINI Countryman: additionally press button 2 using a suitable tool.

4. Pull out the head restraint.
5. Fold back the backrest.

Rear

1. Pull the head restraint upward as far as possible.
2. Fold the backrest forward slightly.
3. Press button 1 and pull out the head restraint all the way to the stop.
MINI Countryman: additionally press button 2 using a suitable tool.
4. Pull out the head restraint completely.
5. Fold back the rear seat backrest.

MIRRORS

Exterior mirrors

General information

The mirror on the passenger side is more curved than the driver's mirror.



WARNING

Objects reflected in the mirror are closer than they appear. The distance to the traffic behind could be incorrectly estimated, e.g. while changing lanes. There is risk of an accident. Estimate the distance to the traffic behind by looking over your shoulder. ◀

Overview

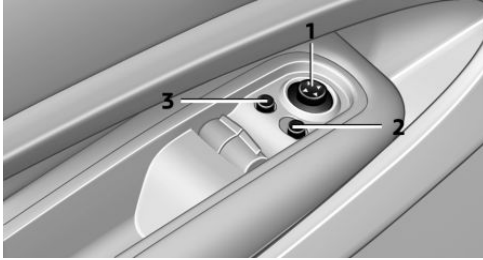

- 1 Adjusting
- 2 Selecting the left/right mirror
- 3 Folding the mirror in and out

Selecting a mirror



To change to the other mirror: slide the mirror switch over.

Adjusting electrically



The setting corresponds to the direction in which the button is pressed.

Adjusting manually

If an electrical malfunction occurs, for example, press the edges of the mirror glass.

Folding the mirror in and out

Press button 3.

The mirror can be folded in up to a vehicle speed of approx. 20 mph/30 km/h.

For example, this is advantageous

- ▷ In car washes.
- ▷ In narrow streets.
- ▷ For folding back mirrors that were folded away manually.

⚠ CAUTION

Depending on the vehicle width, the vehicle can be damaged in car washes. There is risk of property damage. Before washing, fold in the mirrors by hand or with the button. ◀

Automatic heating

Both exterior mirrors are heated automatically while the engine is running or the ignition is switched on when the external temperature is below a certain value.

Interior rearview mirror

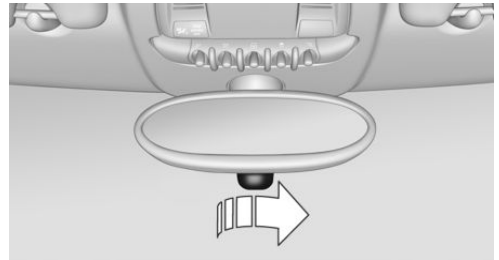

To reduce the blinding effect from the rear when driving at night: turn the knob.

Interior rearview and exterior mirrors, automatic dimming feature

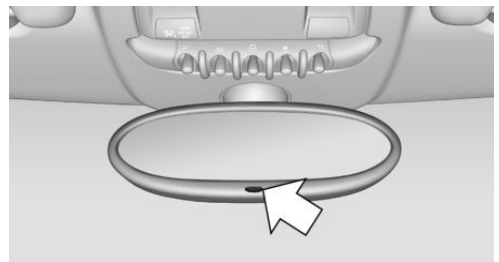

Two photocells are used for control:

- ▷ In the mirror frame, see arrow.
- ▷ On the back of the mirror.

For proper operation:

- ▷ Keep the photocells clean.

- ▷ Do not cover the area between the inside rearview mirror and the windshield.
- ▷ Do not apply stickers to the windshield in front of the mirror.

STEERING WHEEL

Adjusting



WARNING

Steering wheel adjustments while driving can lead to unexpected steering wheel movements. Vehicle control could be lost. There is risk of an accident. Adjust the steering wheel while the vehicle is stationary only. ◀

1. Fold the lever down.

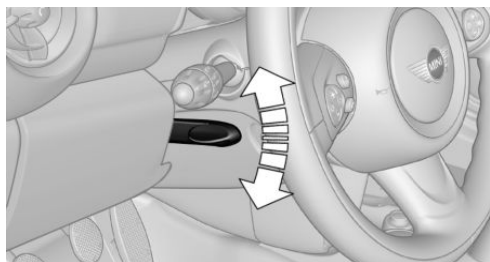

2. Move the steering wheel to the preferred height and angle to suit your seating position.
3. Fold the lever back.

TRANSPORTING CHILDREN SAFELY

VEHICLE FEATURES AND OPTIONS

This chapter describes all standard, country-specific and optional features offered with the series. It also describes features that are not necessarily available in your car, e. g., due to the selected options or country versions. This also applies to safety-related functions and systems.

When using the features and systems described here, adhere to local regulations.

THE RIGHT PLACE FOR CHILDREN

Information



WARNING

Unattended children or animals can move the vehicle and endanger themselves and traffic, e.g. with the following actions:

- ▷ Pressing the Start/Stop button.
- ▷ Releasing the parking brake.
- ▷ Opening and closing of doors or windows.
- ▷ Shifting the selector lever into neutral.
- ▷ Using vehicle equipment.

There is risk of accidents or injuries. Do not leave children or animals unattended in the vehicle. Carry remote control along when exiting and lock the vehicle. ◀

Children should always be in the rear



WARNING

Persons shorter than 5 ft, 150 cm cannot correctly fasten the safety belt without suitable additional restraint systems. The protective effect of the safety belts can be limited or lost

when safety belts are fastened incorrectly. An incorrectly fastened safety belt can cause additional injuries, e.g. in the event of an accident or during braking and evasive maneuvers. There is risk of injuries or danger to life. Secure persons shorter than 5 ft, 150 cm using suitable restraint systems. ◀

Accident research shows that the safest place for children is on the rear seat.

Only transport children younger than 12 years of age (13 years of age) or shorter than 5 ft, 150 cm in the rear in child restraint systems suitable for the age, weight and size of the child.

Children 13 years of age or older must wear a safety belt as soon as a suitable child restraint system can no longer be used due to their age, weight and size.

Children on the front passenger seat

Should it be necessary to use a child restraint fixing system on the front passenger seat, make sure that the front and side airbags on the front passenger side are deactivated, refer to page 83.

Information



WARNING

Active front-seat passenger airbags can injure a child in a child restraint system when the airbags are activated. There is risk of injuries. Make sure that the front-seat passenger airbags are deactivated and that the PASSENGER AIRBAG OFF indicator lamp lights up. ◀



WARNING

The stability of the child restraint system is limited or compromised with incorrect seat adjustment or improper installation of the child seat. There is risk of injuries or danger to life. Make sure that the child restraint system fits

securely against the backrest. If possible, adjust the backrest tilt for all affected backrests and correctly adjust the seats. Make sure that seats and backrests are securely engaged. If possible, adjust the height of the head restraints or remove them. ◀

INSTALLING CHILD RESTRAINT FIXING SYSTEMS

Before mounting

MINI Countryman: before mounting a child restraint fixing system on the rear seats, move the seats into the rearmost positions.

Adjust the inclination of the center backrest to that of the respective outer backrest.

After mounting the child restraint fixing system on the respective outer rear seat, adjust the backrest forward, if necessary, to ensure that the backrest is in contact with the child restraint fixing system. Rear seat backrests, refer to page 111.

Information

Pay attention to the specifications of the child restraint system manufacturer when selecting, installing, and using child restraint systems.



WARNING

The stability of the child restraint system is limited or compromised with incorrect seat adjustment or improper installation of the child seat. There is risk of injuries or danger to life. Make sure that the child restraint system fits securely against the backrest. If possible, adjust the backrest tilt for all affected backrests and correctly adjust the seats. Make sure that seats and backrests are securely engaged. If possible, adjust the height of the head restraints or remove them. ◀

On the front passenger seat

Deactivating the airbags

After installing a child restraint fixing system on the front passenger seat, ensure that the front, side, and knee airbags on the front passenger side are deactivated.

Seat position and height

Before installing a child restraint fixing system, move the front passenger seat as far back as possible and adjust its height to the highest position to obtain the best possible position for the belt and to offer optimal protection in the event of an accident.

Do not change this seat position once it has been set.

Child seat security

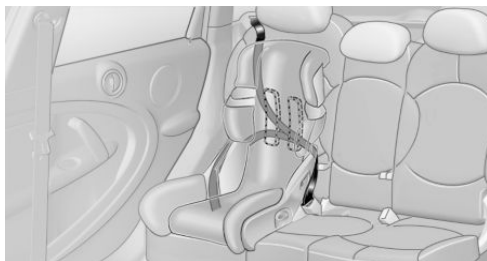

The graphic shows the MINI Countryman as an example.

The rear safety belts and the safety belt for the front passenger can be locked to prevent extension in order to permit attachment of child restraint fixing systems.

To lock the safety belt

1. Secure the child restraint fixing system with the belt.
2. Pull out the belt webbing completely.
3. Allow the belt webbing to be pulled in and pull it taut against the child restraint fixing system.

The safety belt is locked.

To unlock the safety belt

1. Open the belt buckle.
2. Remove the child restraint fixing system.
3. Allow the belt webbing to be pulled in completely.

Center safety belt: unlock belt buckle 3 in addition, refer to page 48.

Guide the safety belt to the holder on the headliner.

LATCH CHILD RESTRAINT FIXING SYSTEM

LATCH: Lower Anchors and Tethers for Children.

Information

Pay attention to the operating and safety information of the child restraint system manufacturer when installing and using LATCH child restraint fixing system.

Mounts for the lower LATCH anchors

The lower anchors may be used to attach the CRS to the vehicle seat up to a combined child and CRS weight of 65 lb/30 kg when the child is restrained by the internal harnesses.

WARNING

If the LATCH child restraint fixing systems are not correctly engaged, the protective effect of the LATCH child restraint fixing system can be limited. There is risk of injuries or danger to life. Make sure that the lower anchors are securely engaged and that the LATCH child restraint fixing system fits securely against the backrest. ◀

Before installing the child seat, pull the belt out of the area for the child restraint fixing system.

MINI Countryman

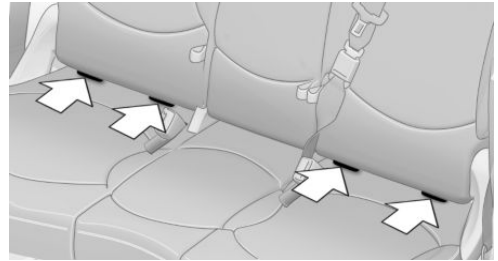

The mounts for the lower LATCH anchors are located at the points indicated by the arrows.

MINI Paceman

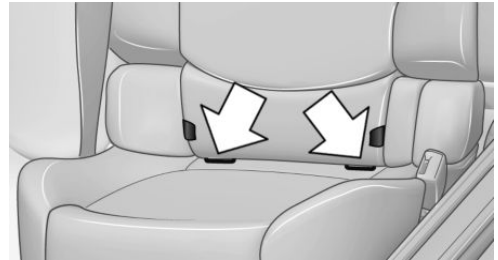

The mounts for the lower LATCH anchors are located at the points indicated by the arrows.



The corresponding symbol shows the mounts for the lower LATCH anchors.



Mounting LATCH child restraint fixing systems

1. Mount the child restraint fixing system; refer to the operating instructions of the system.
2. Ensure that both LATCH anchors are properly connected.

CHILD RESTRAINT FIXING SYSTEMS WITH AN UPPER RETAINING STRAP

Mounting points

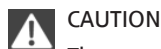

CAUTION

The mounting points for the upper retaining straps of child restraint systems are only provided for these retaining straps. When other objects are mounted, the anchors can be damaged. There is risk of property damage. Only mount child restraint systems to the upper retaining straps. ◀

MINI Countryman



There are two additional mounting points for child restraint fixing systems with an upper retaining strap, arrows.

MINI Paceman

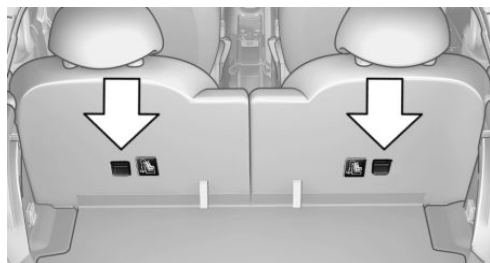

There are two additional mounting points for child restraint fixing systems with an upper retaining strap, arrows.

Guide of the upper LATCH retaining strap



WARNING

If the upper retaining strap is incorrectly used for the child restraint system, the protective effect can be reduced. There is risk of injuries. Make sure that the upper retaining strap is not guided across sharp edges and without twisting to the upper retaining strap. ◀

Outer seats:

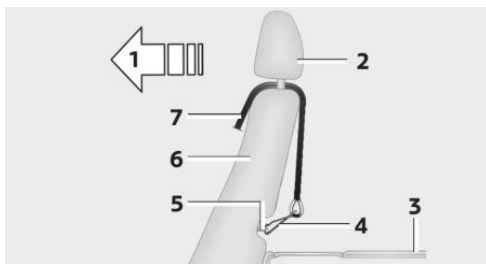

- 1 Direction of travel
- 2 Head restraint
- 3 Cargo area floor
- 4 Hook for upper retaining strap
- 5 Mounting point
- 6 Backrest
- 7 Upper retaining strap of child restraint fixing system

MINI Countryman, center seat

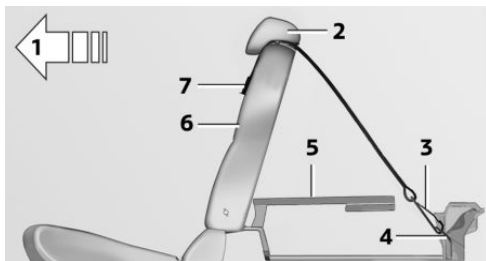

- 1 Direction of travel
- 2 Head restraint

- 3 Hook for upper retaining strap
- 4 Mounting point
- 5 Cargo area floor
- 6 Backrest
- 7 Upper retaining strap of child restraint fixing system

Attaching the upper retaining strap to the mounting point

1. Slide the head restraint upward.
2. Center seat: fold the cargo area floor forward.
3. Guide the upper retaining strap between the supports of the head restraint.
4. Attach the upper retaining strap to the mounting point with the hook.
5. Slide the head restraint into the bottom position.
6. Pull the upper retaining strap taut.



WARNING

If the rear backrest is not locked, the protective effect of the child restraint system is limited or there is none. In particular situations, e.g. braking maneuvers or in case of an accident, the rear backrest can fold forward. There is risk of injuries or danger to life. Make sure that the rear backrests are locked. ◀

MINI COUNTRYMAN: LOCKING DOORS AND WINDOWS

Rear doors

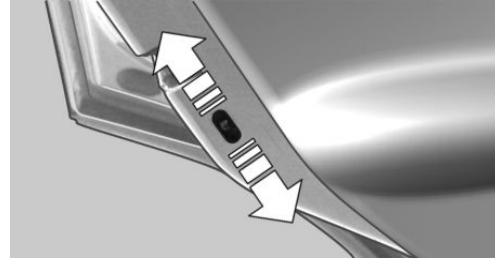

Push the locking lever on the rear doors down. The door can now be opened from the outside only.

Safety switch for power window

This locks the rear window switches so that the windows cannot be operated from the rear. Press the safety switch, refer to page 43.

DRIVING

VEHICLE FEATURES AND OPTIONS

This chapter describes all standard, country-specific and optional features offered with the series. It also describes features that are not necessarily available in your car, e. g., due to the selected options or country versions. This also applies to safety-related functions and systems.

When using the features and systems described here, adhere to local regulations.

IGNITION LOCK

Insert the remote control into the ignition lock

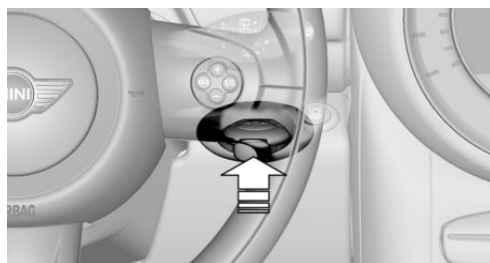

Insert the remote control all the way into the ignition lock.

Radio ready state is switched on. Individual electrical consumers can operate.

Steering wheel lock

Removing the remote control from the ignition lock

Before removing the remote control, push it all the way in to release the locking mechanism.

The ignition is switched off if it was on.

Steptronic transmission

You can only take out the remote control if transmission position P is engaged: interlock.

START/STOP BUTTON

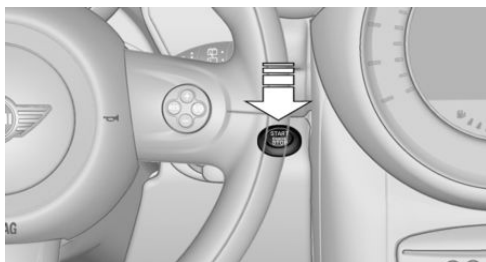

Pressing the Start/Stop button switches the ignition on or off and starts the engine.

The engine starts when the Start/Stop button is pressed and:

- ▷ Manual transmission: the clutch pedal is depressed.
- ▷ Steptronic transmission: the brake pedal is depressed.

Radio ready state

Individual electrical consumers can operate.

Radio ready state is switched off automatically:

- ▷ When the remote control is removed from the ignition lock.
- ▷ With Comfort Access, refer to page 37, by pressing the button on the door handle or the  button on the remote control.
- ▷ After a certain period of time.

Ignition on

All electrical consumers can operate. Most indicator and warning lights light up for different lengths of time.

To save battery power when the engine is off, switch off the ignition and any unnecessary electronic systems/power consumers.

Radio ready state and ignition off

All indicator and warning lights in the displays go out.

The ignition switches off automatically when the driver's door is opened. Pressing the Start/Stop button again switches the ignition back on.

For example, the ignition is not switched off in the following situations:

- ▷ Depress the clutch or brake pedal.
- ▷ The low beams are switched on.

STARTING THE ENGINE

General information



DANGER

If the exhaust pipe is blocked or ventilation is insufficient, harmful exhaust gases can enter into the vehicle. The exhaust gases contain carbon monoxide, an odorless and colorless but highly toxic gas. In enclosed areas, exhaust gases can also accumulate outside of the vehicle. There is danger to life. Keep the exhaust pipe free and ensure sufficient ventilation. ◀



WARNING

An unsecured vehicle can put itself into motion and roll away. There is risk of an accident. Before exiting, secure the vehicle against rolling.

In order to ensure that the vehicle is secured against rolling away, observe the following:

- ▷ Set the parking brake.
- ▷ On uphill grades or on a slope, turn the front wheels in the direction of the curb.

- ▷ On uphill grades or on a slope, additionally secure the vehicle, e.g. with a wheel chock. ◀



CAUTION

In the case of repeated starting attempts or repeated starting in quick succession, the fuel is not burned or is inadequately burned. The catalytic converter can overheat. There is risk of property damage. Avoid repeated starting in quick succession. ◀

Do not wait for the engine to warm-up while the vehicle remains stationary; start driving right away, but at moderate engine speeds.

Do not depress the accelerator when starting the engine.

Starting the engine

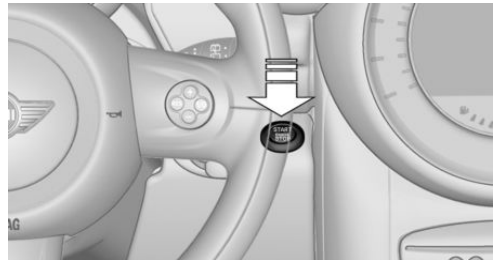

Manual transmission

Remote control in the ignition lock or with Comfort Access inside the vehicle, refer to page 37.

1. Depress the brake pedal.
2. Depress the clutch pedal.
3. Press the Start/Stop button.

The ignition is activated automatically for a certain time and is stopped as soon as the engine starts.

Steptronic transmission

Remote control in the ignition lock or, with Comfort Access, inside the vehicle, refer to page 37.

1. Depress the brake pedal.
2. Move the selector lever to position P or N.
3. Press the Start/Stop button.

The ignition is activated automatically for a certain time and is stopped as soon as the engine starts.

ENGINE STOP

General information



WARNING

Unattended children or animals can move the vehicle and endanger themselves and traffic, e.g. with the following actions:

- ▷ Pressing the Start/Stop button.
- ▷ Releasing the parking brake.
- ▷ Opening and closing of doors or windows.
- ▷ Shifting the selector lever into neutral.
- ▷ Using vehicle equipment.

There is risk of accidents or injuries. Do not leave children or animals unattended in the vehicle. Carry remote control along when exiting and lock the vehicle. ◀



WARNING

An unsecured vehicle can put itself into motion and roll away. There is risk of an accident. Before exiting, secure the vehicle against rolling.

In order to ensure that the vehicle is secured against rolling away, observe the following:

- ▷ Set the parking brake.
- ▷ On uphill grades or on a slope, turn the front wheels in the direction of the curb.

- ▷ On uphill grades or on a slope, additionally secure the vehicle, e.g. with a wheel chock. ◀

Before driving into a car wash

To make it possible for the vehicle to roll in an automatic car wash, follow the information on Washing in automatic car washes, refer to page 254.

Switching off the engine

Manual transmission

1. With the vehicle at a standstill, press the Start/Stop button.
2. Shift into first gear or reverse.
3. Set the parking brake firmly.
4. Remove the remote control from the ignition lock.

Steptronic transmission

1. Engage transmission position P with the vehicle stopped.
2. Press the Start/Stop button.
3. Set the parking brake firmly.
4. Remove the remote control from the ignition lock.

PARKING BRAKE

The concept

The parking brake is primarily intended to prevent the vehicle from rolling while parked; it brakes the rear wheels.

Also follow the instructions under Switching off the engine, refer to page 60.

Setting

The lever engages automatically.

Releasing

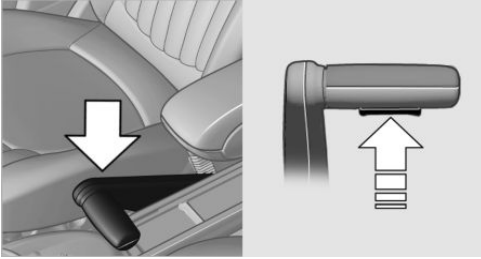

Pull up slightly, press the button, and lower the lever.

Information

If for once use during driving is required, engage the parking brake slightly and hold the button down.

The brake lights do not light up when the parking brake is pulled.

TURN SIGNAL, HIGH-BEAMS, HEADLIGHT FLASHER

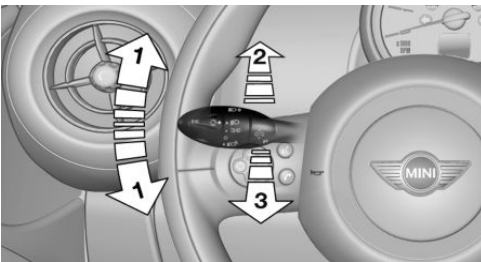

- 1 Turn signal
- 2 Switching on the high-beams
- 3 Switching off the high-beams/headlight flasher

Turn signal

Press the lever beyond the resistance point. To switch off manually, press the lever to the resistance point.

Unusually rapid flashing of the indicator lamp indicates that a turn signal bulb has failed.

Signaling a turn briefly

Press the lever to the resistance point and hold it there for as long as you want the turn signal to flash.

Triple turn signal activation

Press the lever to the resistance point.

The turn signal flashes three times.

This function can be activated or deactivated:

1. "Settings"
2. "Lighting"
3. "Triple turn signal"

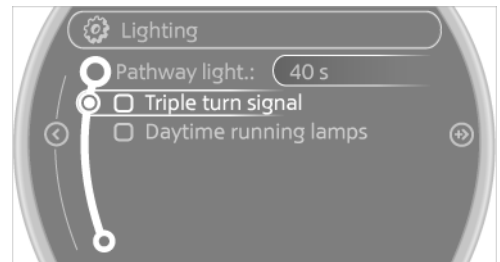

Settings are stored for the remote control currently in use.

WASHER/WIPER SYSTEM

Information

Do not use the wipers if the windshield is dry, as this may damage the wiper blades or cause them to become worn more quickly.



CAUTION

If the wipers are frozen to the windshield, the wiper blades can be torn off and the wiper motor overheat on switching on. There is risk of property damage. Defrost the windshield prior to switching the wipers on. ◀

Overview

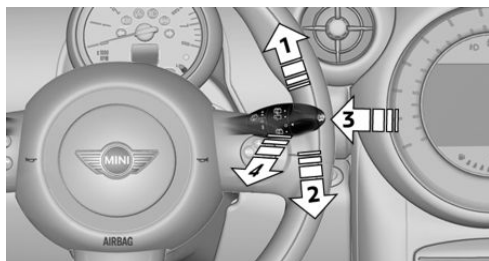

- 1 Switching on wipers
- 2 Switching off wipers or brief wipe
- 3 Activating/deactivating intermittent wipe or the rain sensor
- 4 Cleaning the windshield and headlights

Switching on wipers

Press the wiper lever upward, arrow 1.

The lever automatically returns to its initial position when released.

Normal wiper speed

Press up once.

The system switches to operation in the intermittent mode when the vehicle is stationary.

Fast wiper speed

Press up twice or press once beyond the resistance point.

The system switches to normal speed when the vehicle is stationary.

Switching off wipers or brief wipe

Press the wiper lever down, arrow 2.

The lever automatically returns to its initial position when released.

- ▷ Brief wipe: press down once.
- ▷ To switch off normal wipe: press down once.
- ▷ To switch off fast wipe: press down twice.

Intermittent wipe or rain sensor

If the car is not equipped with a rain sensor, the intermittent-wipe time is a preset.

If the car is equipped with a rain sensor, the time between wipes is controlled automatically and depends on the intensity of the rainfall.

The rain sensor is mounted on the windshield, directly in front of the interior rearview mirror.



CAUTION

If the rain sensor is activated, the wipers can accidentally start moving in car washes. There is risk of property damage. Deactivate the rain sensor in car washes. ◀

Activating intermittent wipe or rain sensor

Press the button, arrow 3.



The symbol is shown in the tachometer.

Setting the sensitivity of the rain sensor

1. Switch on the ignition, refer to page 58.
2. Press the button on the turn indicator lever repeatedly until "SET/INFO" is displayed.

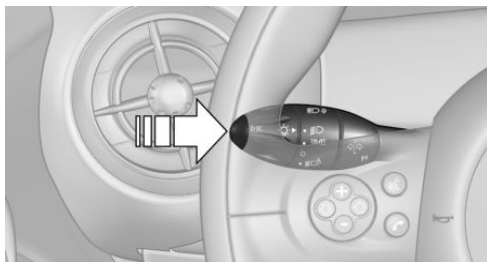

3. Press and hold the button until the display changes.

4. Press the button repeatedly until the symbol and "SET" are displayed.

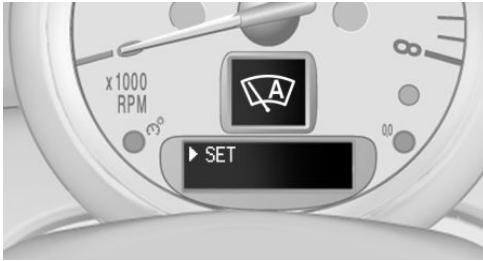

5. Press and hold the button until the display changes.



6. Press the button to select the desired sensitivity.
7. Wait or hold the button until the display changes.
The settings were stored.

Deactivating intermittent wipe or rain sensor

Press the button again, arrow 3.

Cleaning the windshield and headlights

Pull the lever, arrow 4.

The system sprays washer fluid on the windshield and activates the wipers briefly.

When the vehicle lighting system is switched on, the headlights are cleaned at regular and appropriate intervals.

⚠ WARNING

The washer fluid can freeze onto the window at low temperatures and obstruct the view. There is risk of an accident. Only use the washer systems, if the washer fluid cannot freeze. Use antifreeze if needed. ◀

⚠ CAUTION

When the wiper water container is empty, the wash pump cannot work as intended. There is risk of property damage. Do not use the washer system when the wash water container is empty. ◀

⚠ CAUTION

Use of the washer system with the hood open may damage the headlamp washer system. There is a risk of property damage. Only use the washer system if the hood is fully locked. ◀

Windshield washer nozzles

The windshield washer nozzles are heated automatically while the engine is running or the ignition is switched on.

Rear window wiper

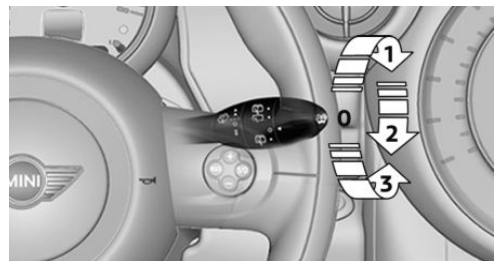

0 Resting position

1 Switching on intermittent wipe

Turn the cap to level 1.

When reverse gear is engaged, the system switches to continuous operation.

2 Cleaning the rear window with intermittent wipe

Turn the cap further to level 2 and hold.

- 3 Cleaning the rear window in the resting position

Turn the cap to level 3 and hold.

The rear window wiper does not move if the cap is in position 1 before the ignition is switched on.

To switch on the rear window wiper:

1. Move the cap to its basic position.
2. Select the required position again.

CAUTION

When the wiper water container is empty, the wash pump cannot work as intended. There is risk of property damage. Do not use the washer system when the wash water container is empty. ◀

WASHER FLUID

General information

WARNING

Some antifreeze agents can contain harmful substances and are flammable. There is risk of fire and risk of injuries. Observe the instructions on the containers. Keep antifreeze away from ignition sources. Do not refill operating materials into different bottles. Store operating materials out of reach of children.

United States: The washer fluid mixture ratio is regulated by the U.S. EPA and many individual states; do not exceed the allowable washer fluid dilution ratio limits that apply. Follow the usage instructions on the washer fluid container.

Use of BMW's Windshield Washer Concentrate or the equivalent is recommended. ◀

WARNING

Washer fluid may catch fire if it comes into contact with hot engine parts. There is risk of injuries or risk of property damage. Only refill washer fluid after the engine has cooled down. Then fully close the cap of the washer fluid reservoir. ◀

Washer fluid reservoir

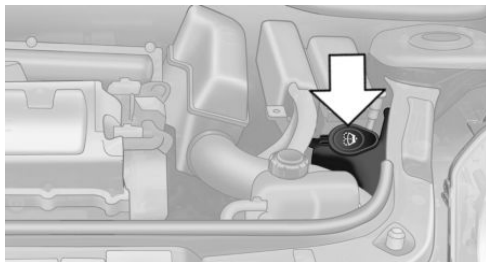

All washer nozzles are supplied from one reservoir.

The recommended minimum filling quantity is 0.2 US gal/1 liter.

Fill with a mixture of window washing concentrate and water; if needed, add antifreeze according to the manufacturer instructions.

Mix the washer fluid before adding to maintain the correct mixing ratio.

Do not fill in undiluted window washing concentrate and do not fill in pure water; this could damage the washer system.

Do not mix window washing concentrate from different manufacturers; this could cause the washer nozzles to clog.

MANUAL TRANSMISSION

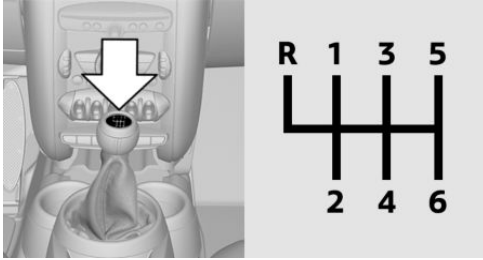

CAUTION

When shifting to a lower gear, excessive speeds can damage the engine. There is risk of property damage. When shifting into 5th or 6th gear, press the gearshift lever to the right. ◀

Reverse gear

Select only when the vehicle is stationary. When the gearshift lever is pressed to the left, a slight resistance needs to be overcome.

STEPTRONIC TRANSMISSION

In addition to the fully automatic mode, gears can also be shifted manually, refer to page 66, using Steptronic.

Parking the vehicle

Before exiting the vehicle, make sure that selector lever position P is set. Otherwise, the vehicle may begin to roll.

Disengaging the remote control

To remove the remote control from the ignition lock, first move the selector lever to position P and switch off the engine: interlock. Remove the remote control from the ignition lock, refer to page 58.

Selector lever positions

P R N D M/S + -

Displays in the tachometer

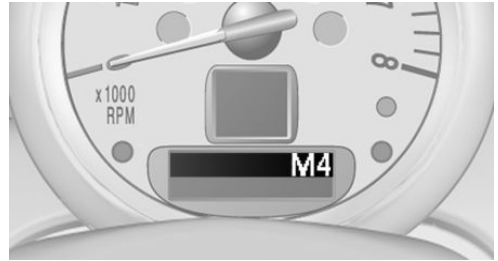

The selector lever position is displayed and the engaged gear, such as M4, is displayed in manual mode.

Changing selector lever positions

- ▷ To prevent the vehicle from creeping after you select a gear, maintain pressure on the brake pedal until you are ready to start.
- ▷ With the ignition switched on or the engine running, the selector lever can be moved out of position P.
- ▷ When the vehicle is stationary, step on the brake before shifting out of P or N; otherwise, the selector lever is locked: shiftlock.

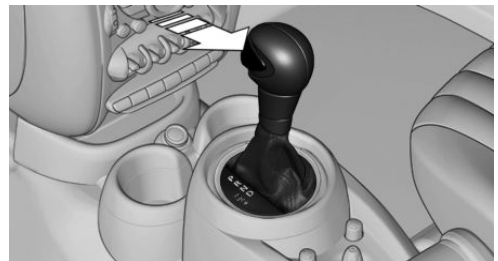

A lock prevents accidental shifting into selector lever positions R and P.

To override the lock, press the button on the front of the selector lever, see arrow.

P Park

Select only when the vehicle is stationary. The front wheels are blocked.

R is Reverse

Select only when the vehicle is stationary.

N is Neutral

For example, engage this position in a car wash. The vehicle can roll.

D Drive

Position for normal vehicle operation. All forward gears are selected automatically.

Under normal operating conditions, fuel consumption is lowest when you are driving in position D.

Kickdown

Kickdown is used to achieve maximum driving performance. Press on the accelerator beyond the resistance point at the full throttle position.

Sport program and manual mode M/S

Activating the Sport program



Move the selector lever from position D toward the left into the M/S shifting slot.

The Sport program is activated and DS is displayed. This position is recommended for a performance-oriented driving style.

To deactivate the Sport program or manual mode M/S, move the selector lever to the right into position D.

Activating the M/S manual mode

Move the selector lever from position D toward the left into the M/S shifting slot.

Push the selector lever forward or backward.

Manual mode becomes active and the gear is changed.

The tachometer displays the engaged gear, e. g. M1.

- ▷ To shift up: press the selector lever backward.
- ▷ To shift down: press the selector lever forward.

The vehicle only shifts up or down at suitable engine and road speeds, e.g., it does not shift down if the engine speed is too high. The selected gear is briefly displayed in the instrument panel, followed by the current gear.

Shifting gears using the shift paddles on the steering wheel

The shift paddles on the steering wheel allow you to shift gears quickly while keeping both hands on the steering wheel.

- ▷ When the shift paddles on the steering wheel are used to shift gears while in automatic mode, the transmission switches to manual mode.
- ▷ If the shift paddles are not used to accelerate or shift gears for a certain amount of time, the transmission switches back to automatic mode.

If the selector lever is in the M/S gear plane, manual mode remains active.

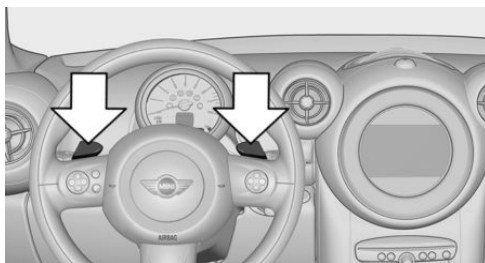

- ▷ Pull one of the two shift paddles: The transmission shifts up.
- ▷ Press one of the two shift paddles:

The transmission shifts down.

The vehicle only shifts up or down at suitable engine and road speeds, e.g., it does not shift down if the engine speed is too high. The selected gear is briefly displayed in the instrument panel, followed by the current gear.

Manually unlocking the selector lever lock

If the selector lever is locked in position P although the ignition is switched on, the brake is depressed, and the button on the selector lever is pressed, the selector lever lock can be overridden:

1. Switch off the ignition.
2. Unclip the sleeve of the selector lever.
3. Pull the sleeve up over the selector lever until the sleeve is inside out.

Pull off the plug-in cable connector if necessary.

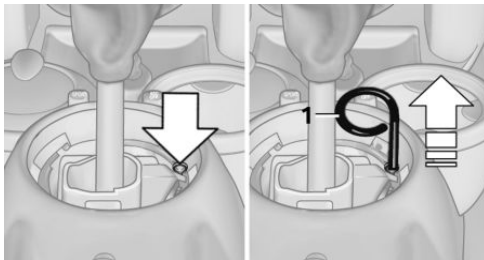

4. Insert the pulling hook 1 into the loop on the passenger side.
The pulling hook is found in the vehicle document portfolio or in the pouch of the wheel change set, refer to page 245.
5. Pull the loop upward.
6. Move the selector lever into the desired position, pressing the button on the front of the selector lever.



WARNING

If the transmission lock is released manually, the vehicle may begin to roll. There is risk of an accident. Before manually unlocking the transmission lock, set the parking brake to prevent the vehicle from rolling away. ◀

DISPLAYS

VEHICLE FEATURES AND OPTIONS

This chapter describes all standard, country-specific and optional features offered with the series. It also describes features that are not necessarily available in your car, e. g., due to the selected options or country versions. This also applies to safety-related functions and systems.

When using the features and systems described here, adhere to local regulations.

ODOMETER, EXTERNAL TEMPERATURE DISPLAY, CLOCK

Overview

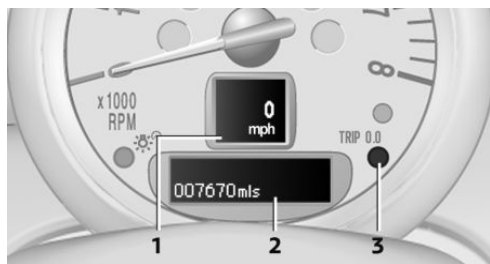

- 1 Current speed
- 2 Odometer, trip odometer, external temperature, time
- 3 Resetting the trip odometer

Press the button on the turn indicator lever to open information in display area 2.

The following information is displayed consecutively:

- ▷ Trip odometer
- ▷ Time
- ▷ External temperature

Trip odometer

Displaying the trip odometer

Press button 3 briefly.

Resetting the trip odometer

1. Press button 3 briefly.
The trip odometer is displayed.
2. Press button 3 again.
The trip odometer is reset.

Time

Set the time, refer to page 72.

External temperature, external temperature warning

If the display drops to $+37^{\circ}\text{F}/+3^{\circ}\text{C}$, a signal sounds and a warning light lights up. There is the increased danger of ice.



WARNING

Even at temperatures above $+37^{\circ}\text{F}/+3^{\circ}\text{C}$ there can be a danger of icy roads, e.g. on bridges or shady sections of road. There is risk of an accident. Adjust your driving style to the weather conditions at low temperatures ◀

Units of measure

To set the respective units of measure, miles or km for the odometer and $^{\circ}\text{C}$ or $^{\circ}\text{F}$ for the external temperature, refer to page 72.

TACHOMETER



It is imperative that you avoid engine speeds in the red warning field. In this range, the fuel supply is interrupted to protect the engine.

COOLANT TEMPERATURE

A warning light will come on if the coolant, and therefore the engine, becomes too hot. In addition, a message will appear on the Control Display.

Check the coolant level, refer to page [234](#).

FUEL GAUGE

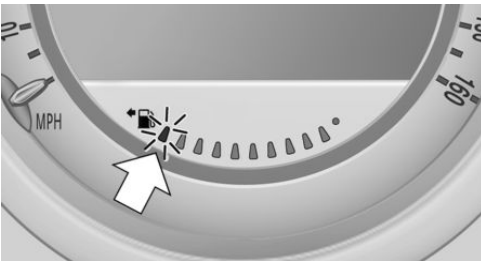

The arrow next to the fuel pump symbol on the fuel gauge indicates the side of the vehicle with the fuel filler flap.

The vehicle inclination may cause the display to vary.

Notes on refueling, refer to page [214](#).

Filling capacities, refer to page [263](#).

Range

After the reserve range is reached:

- ▷ The remaining LEDs change from orange to red, arrow.
- ▷ A message is briefly displayed on the Control Display.
- ▷ The remaining range is shown on the tachometer.
- ▷ When a dynamic driving style is used, such as when corners are taken rapidly, engine functions are not ensured.

The message appears continuously below a range of approx. 30 miles/50 km.



CAUTION

With a range of less than 30 miles/50 km it is possible that the engine will no longer have sufficient fuel. Engine functions are no longer ensured. There is risk of property damage. Refuel promptly. ◀

COMPUTER

Opening information in the tachometer

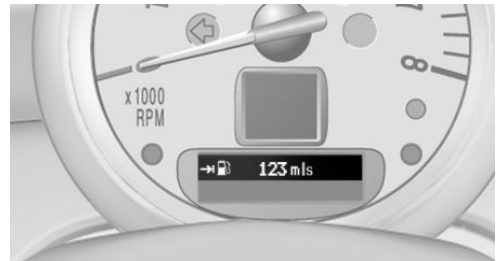

Press the button on the turn indicator lever.

Overview of the information

The following information is displayed consecutively by repeatedly pressing the button on the turn indicator lever:

- ▷ Range.
- ▷ Average fuel consumption.

- ▷ Current fuel consumption.
- ▷ Average speed.

To set the corresponding units of measure, refer to page 72.

Information in detail

Range

Displays the estimated cruising range available with the remaining fuel.

It is calculated based on your driving style over the last 18 miles/30 km.

Average fuel consumption

This is calculated for the period during which the engine is running.

With the trip computer, refer to page 70, the average consumption can be displayed for an additional distance.

To reset the average consumption: press the button on the turn indicator lever for approx. 2 seconds.

Current fuel consumption

Displays the current fuel consumption. You can check whether you are currently driving in an efficient and environmentally-friendly manner.

Average speed

Periods in which the vehicle was parked and the engine was switched off manually are not included in the average speed calculations.

With the trip computer, refer to page 70, the average speed can be displayed for an additional distance.

To reset the average speed: press the button on the turn indicator lever for approx. 2 seconds.

Displays on the Control Display

Display the computer or trip computer on the Control Display.

1. "Vehicle Info"
2. "Onboard info" or "Trip computer"

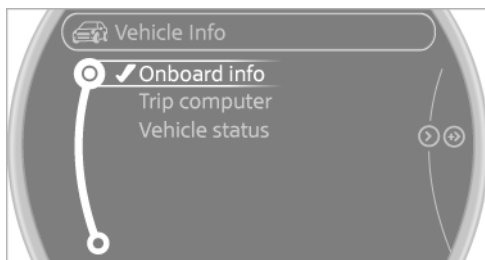

Displays on the "Onboard info":

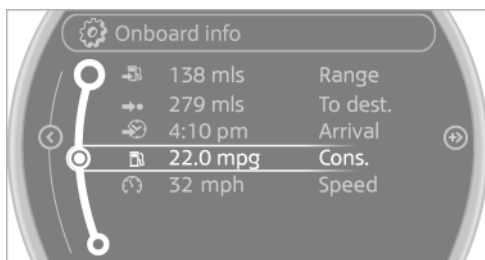

- ▷ Range.
- ▷ Distance to destination.
- ▷ Estimated time of arrival if a destination was entered in the navigation system.

Displays on the "Trip computer":

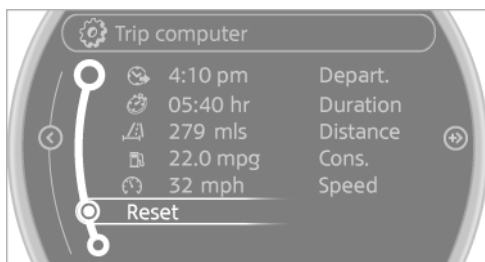

- ▷ Departure time.
- ▷ Trip duration.
- ▷ Trip distance.

Both displays show:

- ▷ Average fuel consumption.
- ▷ Average speed.

Resetting the fuel consumption and speed

Resetting the values for average speed and average fuel consumption:

1. Select the respective menu item and press the MINI joystick.
2. Press the MINI joystick again to confirm your selection.

Resetting the trip computer

Resetting all values:

1. "Vehicle Info"
2. "Trip computer"
3. "Reset"

SETTINGS AND INFORMATION





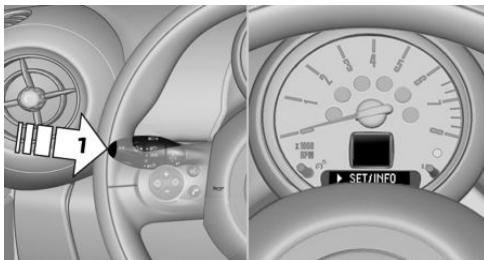

Operating concept

Some settings and information can only be created or opened while the ignition is switched on, the vehicle is standing, and the doors are closed.



- 1 Button for:
 - ▷ Selecting the display.
 - ▷ Setting values.
 - ▷ Confirming the selected display or set values.

- ▷ Calling up computer information 69.

Symbol	Function
	Set the rain sensor, refer to page 62.
	
	Open Check-Control, refer to page 75.
	
	Exit the menu.
	

Exiting displays



1. Press the button on the turn indicator lever repeatedly until "HOME" is displayed.
2. Hold the button down.

The current speed is displayed again.

Displays are also exited if no entries are made within approx. 8 seconds.

Next setting or information

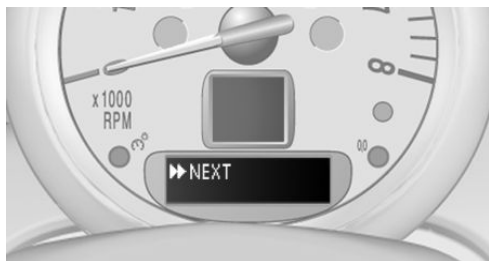

1. Within a setting or information display, press the button on the turn indicator lever repeatedly until "NEXT" is displayed.
2. Hold the button down.

Direct change to the next setting or piece of information.

UNITS OF MEASURE

The units of measure, such as for fuel consumption, route/distance, and temperature, can be changed. The settings are stored for the remote control currently in use.

1. "Settings"
2. "Language/Units"

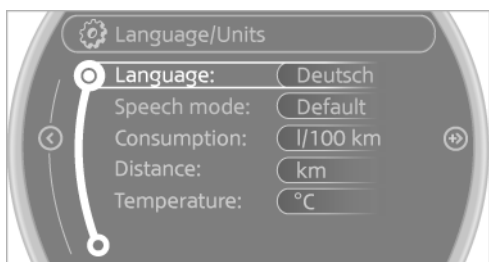

3. Select the desired menu item.
4. Select the desired unit.

CLOCK

Setting the time

1. "Settings"

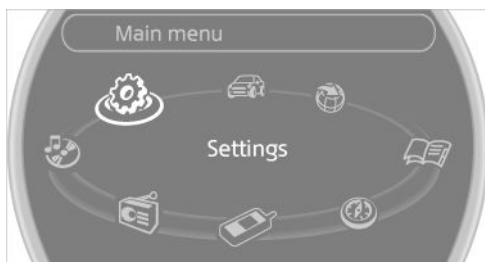

2. "Time/Date"

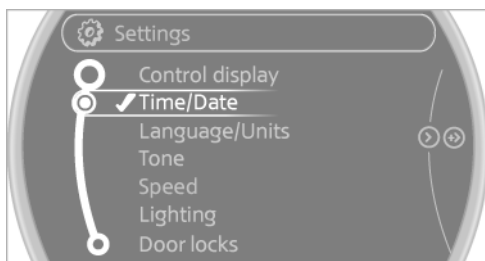

3. "Time:"

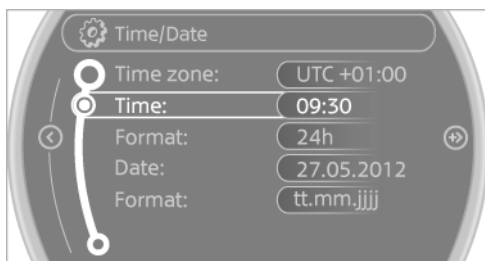

4. Turn the MINI joystick to set the hours and press the MINI joystick.
5. Turn the MINI joystick to set the minutes and press the MINI joystick.

The time is stored.

Setting the time format

1. "Settings"
2. "Time/Date"

3. "Format:"
4. Select the desired format.

The time format is stored.

The settings are stored for the remote control currently in use.

Setting the time zone

1. "Settings"
2. "Time/Date"
3. "Time zone:"
4. Turn the MINI joystick until the desired time zone is displayed and press the MINI joystick.

The time zone is stored.

DATE

Setting the date

1. "Settings"
2. "Time/Date"
3. "Date:"
4. Turn the MINI joystick until the desired day is displayed and press the MINI joystick.
5. Make the necessary settings for the month and year.

The date is stored.

Setting the date format

1. "Settings"
2. "Time/Date"

3. "Format:"
4. Select the desired format.

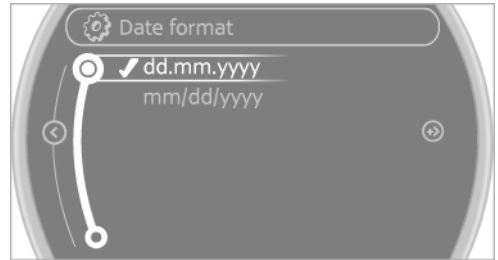

The settings are stored for the remote control currently in use.

SETTINGS ON THE CONTROL DISPLAY

Language

Setting the language

1. "Settings"
2. "Language/Units"
3. "Language:"

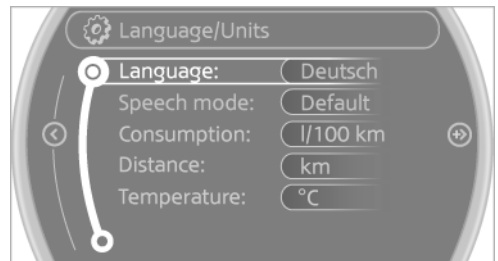

4. Select the desired language.

Settings are stored for the remote control currently in use.

Setting the voice dialog

Voice dialog for the voice activation system, refer to page 25.

Brightness

The brightness is automatically adapted to the ambient lighting conditions. However, the basic setting can be changed when the low beams are switched on.

1. "Settings"
2. "Control display"
3. "Brightness"

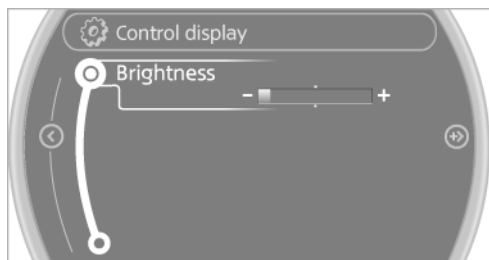

4. Turn the MINI joystick until the desired setting is selected.
5. Press the MINI joystick.

Settings are stored for the remote control currently in use.

Depending on the light conditions, the brightness control may not be clearly visible.

SERVICE REQUIREMENTS



The remaining driving distance and the date of the next scheduled service are displayed briefly immediately after you start the engine or switch on the ignition.

A service advisor can read out the current service requirements from your remote control.

Detailed information on service requirements

More information on the scope of service required can be displayed on the Control Display.

1. "Vehicle Info"
2. "Vehicle status"

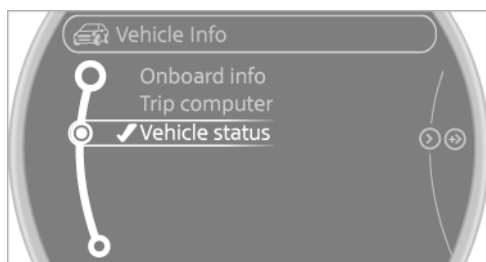

3. "Service required"

Required maintenance procedures and legally mandated inspections are displayed.



Additional information can be displayed on each entry:

Select the entry and press the MINI joystick.

To exit from the menu:

Move the MINI joystick to the left.

Symbols

Symbols	Description
	No service is currently required.
	The deadline for scheduled maintenance or a legally mandated inspection is approaching.
	The service deadline has already passed.

Entering appointment dates

Enter the dates for the required inspections.

Make sure the date on the Control Display is set correctly.

1. "Vehicle Info"
2. "Vehicle status"
3. "Service required"

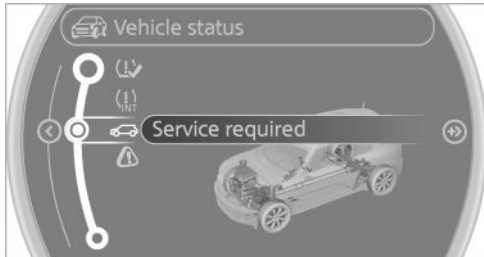

4. "§ Vehicle inspection"

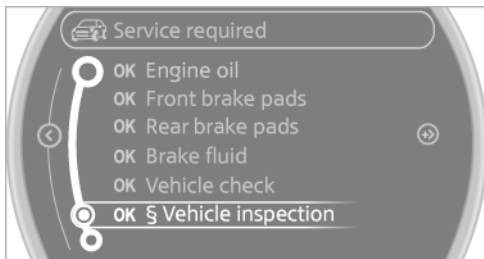

5. Open the menu for entering the deadline.
6. "Date:"
7. Adjust the settings.
8. Press the MINI joystick to apply the setting. The year is highlighted.
9. Turn the MINI joystick to create the setting.
10. Press the MINI joystick to apply the setting. The date entry is stored.

To exit from the menu:

Move the MINI joystick to the left.

CHECK CONTROL

The concept

The Check Control monitors vehicle functions and alerts you to any malfunctions in the systems being monitored.

A Check Control message consists of indicator and warning lights in the instrument cluster and, in some circumstances, an acoustic signal and text messages at the top of the Control Display.

Indicator/warning lights

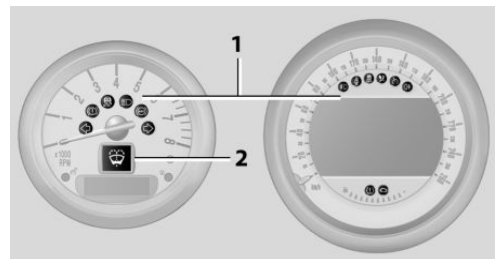

The indicator and warning lights can light up in a variety of combinations and colors in display area 1 or 2.

Several of the lights are checked for proper functioning and light up temporarily when the engine is started or the ignition is switched on.

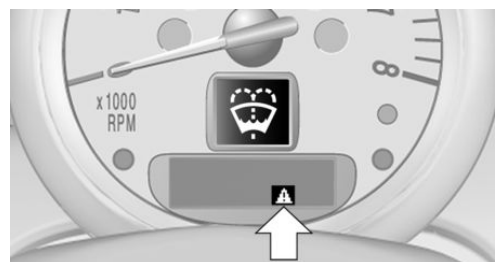

⚠ The symbol indicates that Check Control messages have been stored. The Check Control messages can be displayed later.

Text messages

Text messages at the upper edge of the Control Display in combination with a symbol in the instrument cluster explain a Check Control message and the meaning of the indicator and warning lights.

Supplementary text messages

Additional information, such as on the cause of a fault or the required action, can be called up via Check Control.

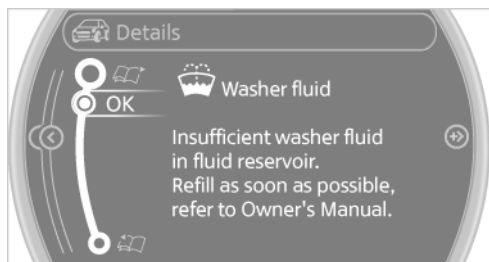

In urgent cases, this information will be shown as soon as the corresponding light comes on.

Hiding Check Control messages

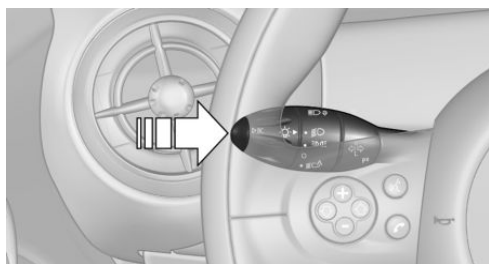

Press the button on the turn indicator lever.

Some Check Control messages are displayed continuously and are not cleared until the malfunction is eliminated. If several malfunctions occur at once, the messages are displayed consecutively.



They are marked with the symbol shown here.

Other Check Control messages are hidden automatically after approx. 20 seconds. However, they are stored and can be displayed again later.



They are marked with the symbol shown here.

Viewing stored Check Control messages

The stored Check Control messages can only be displayed while the driver's door is closed.

1. Press the button on the turn indicator lever repeatedly until "SET/INFO" is displayed.

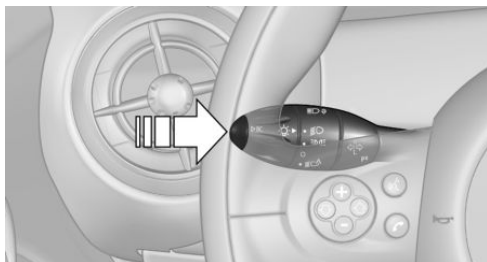

2. Press and hold the button until the display changes.
3. Press the button repeatedly until the corresponding symbol and "CHECK INFO" appear on the display.

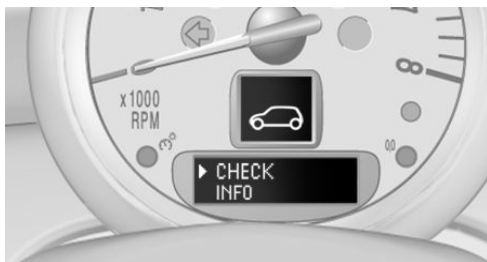

4. Press and hold the button.

If there is no Check Control message, this is indicated by "CHECK OK".

If a Check Control message has been stored, the corresponding message is displayed.

The text message is also displayed on the Control Display.

5. Press the button to check for other messages.

Displaying on the Control Display

1. "Vehicle Info"
2. "Vehicle status"
3. "Check Control"

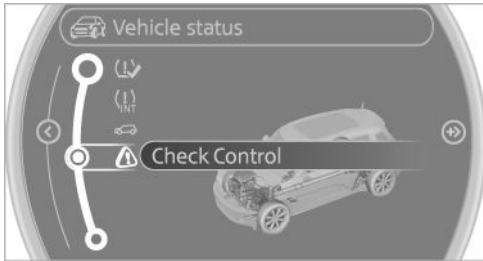

4. Select the text message.

LAMPS

VEHICLE FEATURES AND OPTIONS

This chapter describes all standard, country-specific and optional features offered with the series. It also describes features that are not necessarily available in your car, e. g., due to the selected options or country versions. This also applies to safety-related functions and systems.

When using the features and systems described here, adhere to local regulations.

OVERVIEW

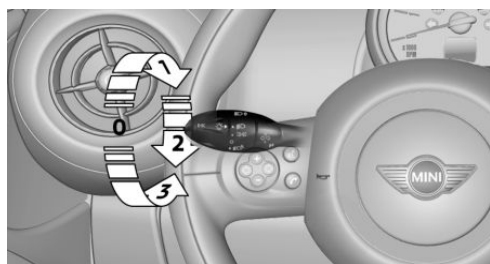

- 0 Lamps off / daytime running lights
- 1 Parking lights and daytime running lights
- 2 Low-beam headlights and welcome lights
- 3 Automatic headlight control, Adaptive Light Control, daytime running lights, and welcome lights

PARKING LIGHTS/LOW BEAMS, HEADLIGHT CONTROL

General information

When the driver's door is opened with the ignition switched off, the exterior lighting is automatically switched off when the light switch is in position 0, 2, or 3.

Switch on the parking lights if necessary, switch position 1.

Parking lights

Switch position 1: the vehicle lights light up on all sides.

Do not use the parking lights for extended periods; otherwise, the battery may become discharged and it would then be impossible to start the engine.

When parking, it is preferable to switch on the one-sided roadside parking lights, refer to page 79.

Low beams

Switch position 2: the low beams are lit when the ignition is switched on.

Automatic headlight control

Switch position 3: the low beams are switched on and off automatically depending on the ambient light, e.g., in tunnels, in twilight, or if there is precipitation. Adaptive Light Control is active.

A blue sky with the sun low on the horizon can cause the lights to be switched on.

The low beams remain switched on independent of the ambient lighting conditions when you switch on the front fog lights.

The exterior lighting goes out automatically after the vehicle is switched off.

System limits

The automatic headlamp control cannot serve as a substitute for your personal judgment of lighting conditions.

For example, the sensors are unable to detect fog or hazy weather. To avoid safety risks, you should always switch on the lights manually under these conditions.

High-beams/roadside parking lights

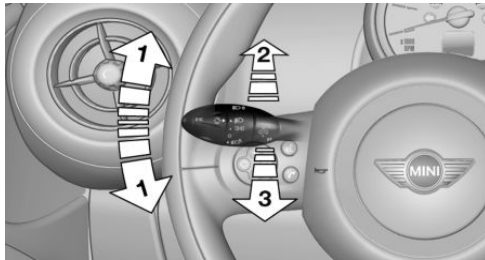

- 1 Turn signal/roadside parking light
- 2 Switching on the high-beams
- 3 Switching off the high-beams/headlight flasher

To assist in parking, the vehicle can be illuminated on one side; note the country-specific regulations.

The roadside parking lights drain the battery. Therefore, do not leave them on for unduly long periods of time; otherwise, the battery might not have enough power to start the engine.

Switching on the roadside parking light

To switch on the roadside parking light on the left or right, press the turn indicator lever up or down after switching off the vehicle, arrow 1.

Switching off the roadside parking light

Press the lever up or down to the resistance point.

Daytime running lights

The daytime running lights light up in switch position 0, 1, or 3 when the ignition is switched on.

The exterior lighting goes out automatically after the vehicle is switched off.

In switch position 1, the parking lights light up after the ignition is switched off.

Activating/deactivating

In some countries, driving with daytime running lights is mandatory; for this reason, daytime running lights cannot be deactivated in these cases.

1. "Settings"
2. "Lighting"
3. "Daytime running lamps"

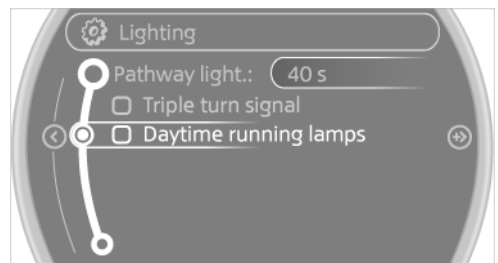

Settings are stored for the remote control currently in use.

Welcome lights

If the light switch stays in switch position 2 or 3 after the vehicle is switched off, the parking lights and the interior lights light up for a certain period when the vehicle is unlocked.

Headlight courtesy delay feature

The low beams stay lit for a short while after the ignition is switched off, if the lights are switched off and the headlight flasher is switched on.

Setting the duration

1. "Settings"
2. "Lighting"
3. "Pathway light.: s"

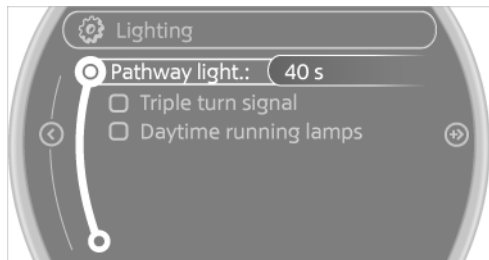

4. Set the duration.

Settings are stored for the remote control currently in use.

ADAPTIVE LIGHT CONTROL

The concept

Adaptive Light Control is a variable headlight control system that enables dynamic illumination of the road surface.

Depending on the steering angle and other parameters, the light from the headlight follows the course of the road.

Activating

With the ignition switch on, turn the light switch to position 3, refer to page 78.

To avoid blinding oncoming traffic, the Adaptive Light Control does not swivel to the driver's side when the vehicle is at a standstill.

When driving in reverse, Adaptive Light Control is not active.

Malfunction



The warning light lights up. A message appears on the Control Display. Adaptive Light Control is malfunctioning or

has failed. Have the system checked as soon as possible.

FOG LIGHTS

Overview

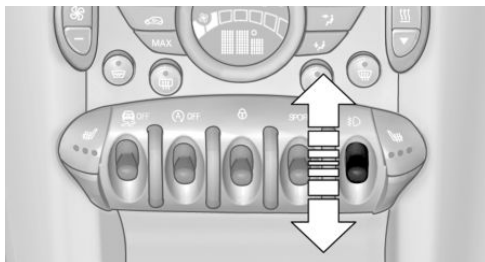

To switch on the front fog lights: press the switch.

To switch off, press the respective switch upward or downward again.

Fog lights

The parking lights or low beams must be switched on. The green indicator lamp lights up when the front fog lights are switched on.

Depending on the vehicle equipment, the front fog lights are switched off when the headlight flasher or the high-beams are activated.

If the automatic headlight control is activated, refer to page 78, the low beams are switched on automatically when the front fog lights are switched on.

INSTRUMENT LIGHTING

The parking lights or low beams must be switched on to adjust the brightness. The brightness is increased to a certain limit and is then reduced again.

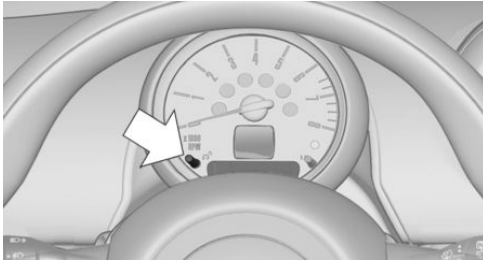

- ▷ Press the button briefly: the brightness changes in stages.
- ▷ Press and hold the button: the brightness changes continuously.

INTERIOR LIGHTS

The interior lights, the footwell lights and the cargo area light are controlled automatically. To avoid draining the battery, all lights inside the vehicle are switched off some time after the ignition is switched off.

Switching interior lights on/off manually

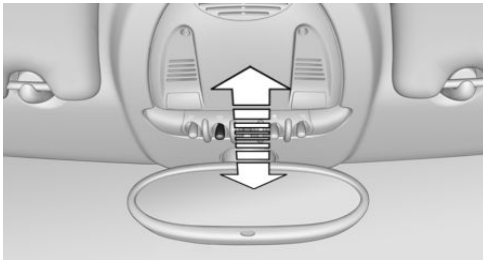

To switch the interior lights on/off: press the switch.

If the interior lights are to remain switched off, press the switch for approx. 3 seconds.

Reading lights

Reading lights are located in the front next to the interior light and in the rear.

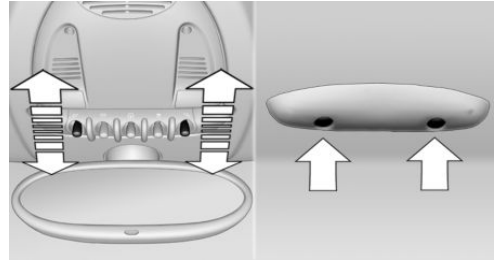

Switching the reading lights on/off

Front: press the switch.

Rear: press the button.

Ambient lighting

The color and brightness of the ambient lighting can be changed.

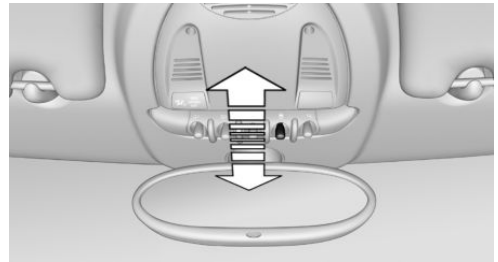

Press the switch forward: the color changes in steps.

Press the switch back: the brightness changes in steps.

Intermediate settings and intermediate colors are possible.

For continuously changing colors of the ambient lighting, press the switch forward for more than 10 seconds.

For Canadian vehicles:

Continuously changing colors of the ambient lighting is not available.

SAFETY

VEHICLE FEATURES AND OPTIONS

This chapter describes all standard, country-specific and optional features offered with the series. It also describes features that are not necessarily available in your car, e. g., due to the selected options or country versions. This also applies to safety-related functions and systems.

When using the features and systems described here, adhere to local regulations.

AIRBAGS

The graphic shows the MINI Paceman as an example.

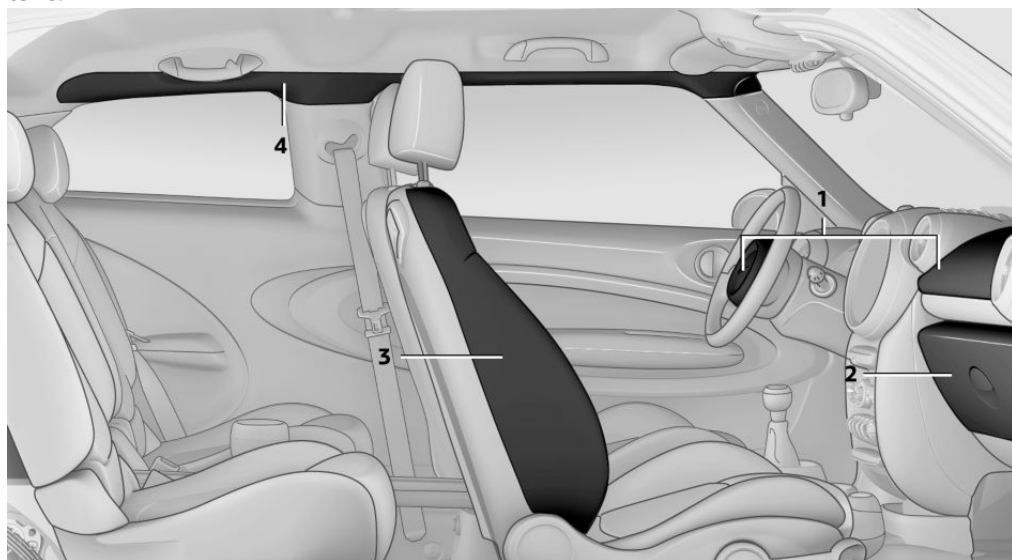

- 1 Front airbags
- 2 Knee airbag

- 3 Side airbag
- 4 Head airbags

Front airbags

Front airbags help protect the driver and front passenger by responding to frontal impacts in which safety belts alone cannot provide adequate restraint.

Side airbags

In a lateral impact, the side airbag supports the side of the body in the chest and lap area.

Head airbags

In a lateral impact, the head airbag supports the head.

Knee airbag

The knee airbag supports the legs in a frontal impact.

Protective action

Airbags are not triggered in every impact situation, e.g., in less severe accidents or rear-end collisions.

Information for optimum effect of the airbags



WARNING

If the seat position is incorrect or the deployment area of the airbags is impacted, the airbag system cannot protect as intended or cause additional injuries due to triggering. There is risk of injuries or danger to life. Follow the information on optimum protective effect of the airbag system. ◀

- ▷ Keep at a distance from the airbags.
- ▷ Always grasp the steering wheel on the steering wheel rim, holding your hands at the 3 o'clock and 9 o'clock positions, to keep the danger of injury to your hands or arms as low as possible if the airbag is triggered.
- ▷ There should be no people, animals, or objects between an airbag and a person.
- ▷ Do not use the cover of the front airbag on the front passenger side as a storage area.
- ▷ Keep the dashboard and window on the front passenger side clear, i.e., do not cover with adhesive labels or coverings, and do not attach holders or cables such as for navigation instruments and mobile phones.
- ▷ Make sure that the front passenger is sitting correctly, i.e., keeps his or her feet and legs in the footwell; otherwise, leg injuries can occur if the front airbag is triggered.
- ▷ Do not attach covers, cushions, ball mats or other items to the front passenger seat un-

less they are specifically determined to be safe for use on the front passenger seat.

- ▷ Do not hang pieces of clothing, such as jackets, over the backrests.
- ▷ Make sure that occupants keep their heads away from the side airbag and do not rest against the head airbag; otherwise, injuries can occur if the airbags are triggered.
- ▷ Do not remove the airbag restraint system.
- ▷ Do not remove the steering wheel.
- ▷ Do not apply adhesive materials to the airbag cover panels, cover them or modify them in any way.
- ▷ Never modify either the individual components or the wiring in the airbag system. This also applies to steering wheel covers, the dashboard, the seats, the roof pillars and the sides of the headliner.

Even when all instructions are followed closely, injury from contact with the airbags cannot be ruled out in certain situations.

The ignition and inflation noise may lead to short-term and, in most cases, temporary hearing impairment in sensitive individuals.

Warning notices and information about the airbags can also be found on the sun visors.

Automatic deactivation of the front passenger airbags

The system determines whether the front passenger seat is occupied by measuring the electrical resistance of the human body.

The front, side, and knee airbags on the front passenger side are activated or deactivated accordingly by the system.

The indicator lamp above the interior rearview mirror, refer to page 84, shows the current status of the front passenger airbags, deactivated or activated.

Before transporting a child on the front passenger seat, read the safety and operating instructions under Transporting children safely, refer to page 53.

**WARNING**

The ensure the front-seat passenger airbag function, it must be detected, whether a person occupies the front passenger seat. The entire seat cushion area must be used for this purpose. There is risk of injuries or danger to life. Make sure that the front passenger keeps his or her feet in the floor area. ◀

Malfunction of the automatic deactivation system

When transporting older children and adults, the front passenger airbags may be deactivated in certain sitting positions. In this case, the indicator lamp for the front passenger airbags lights up.

In this case, change the sitting position so that the front passenger airbags are activated and the indicator lamp goes out.

If it is not possible to activate the airbags, have the person sit in the rear.

To make sure that occupation of the seat cushion can be detected correctly:

- ▷ Do not attach covers, cushions, ball mats or other items to the front passenger seat unless they are specifically determined to be safe for use on the front passenger seat.
- ▷ Do not place electronic devices on the passenger seat if a child restraint fixing system is mounted on the seat.
- ▷ Do not place objects under the seat that could press against the seat from below.

Indicator light for the front passenger airbags



The indicator lamp for the front passenger airbags indicates the operating state of the front passenger airbags.

The light indicates whether the airbags are activated or deactivated.



- ▷ The indicator lamp lights up when a child who is properly seated in a child restraint fixing system intended for that purpose is detected on the seat or the seat is empty. The airbags on the front passenger side are not activated.

- ▷ The indicator lamp does not light up when, for example, a correctly seated person of sufficient size is detected on the seat. The airbags on the front passenger side are activated.

Most child seats are detected by the system. Especially the child seats required by NHTSA at the time that the vehicle was manufactured. After installing a child seat, make sure that the indicator lamp for the front passenger airbags lights up. This indicates that the child seat has been detected and the front passenger airbags are not activated.

Operational readiness of airbag system

Information



WARNING

Individual components can be hot after triggering of the airbag system. There is risk of injuries. Do not touch individual components. ◀



WARNING

Improperly executed work can lead to failure, malfunction or unintentional triggering of the airbag system. In the case of a malfunction, the airbag system could not trigger as intended in the event of an accident despite respective accident severity. There is risk of injuries or danger to life. Have the airbag system checked, repaired, dismantled and scrapped by a dealer's service center or another qualified service center or repair shop. ◀

Correct function

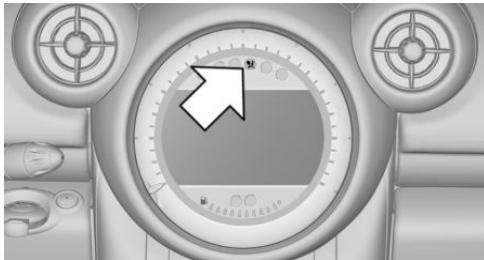

In the radio ready state and beyond, refer to page 58, the warning light lights up briefly to indicate that the entire airbag system and the belt tensioners are operational.

Airbag system malfunction

- ▷ Warning light does not light up in the radio ready state.
- ▷ Warning light remains permanently on.

The airbag restraint system and belt tensioner are not working. Have the vehicle checked im-

mediately by a dealer's service center or another qualified service center or repair shop.

FTM FLAT TIRE MONITOR

The concept

The system does not measure the actual inflation pressure in the tires.

The system detects a pressure loss in a tire by comparing the rotational speeds of the individual wheels while moving.

In the event of a pressure loss, the diameter and therefore the rotational speed of the corresponding wheel change. This is detected and reported as a flat tire.

Functional requirements

The system must have been initialized when the tire inflation pressure was correct; otherwise, reliable signaling of a flat tire is not ensured.

Initialize the system after each correction of the tire inflation pressure and after every tire or wheel change.

System limits

A natural, even pressure loss in all four tires cannot be detected. Therefore, check the tire inflation pressure regularly.

Sudden serious tire damage caused by external influences cannot be indicated in advance.

The system could be delayed or malfunction in the following situations:

- ▷ When the system has not been initialized.
- ▷ When driving on a snowy or slippery road surface.
- ▷ Sporty driving style: slip in the drive wheels, high lateral acceleration.
- ▷ When driving with snow chains.

Status display

The current status of the Flat Tire Monitor can be displayed on the Control Display, e.g., whether or not the FTM is active.

1. "Vehicle Info"
2. "Vehicle status"
3. "Flat Tire Monitor"

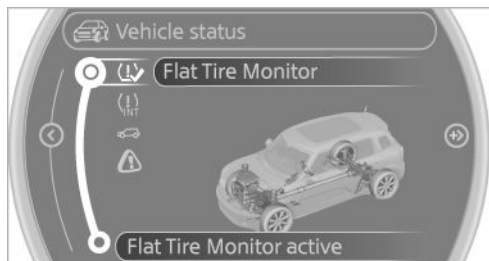

The status is displayed.

Initialization

The initialization process adopts the set inflation tire pressures as reference values for the detection of a flat tire. Initialization is started by confirming the inflation pressures.

Do not initialize the system when driving with snow chains.

1. "Vehicle Info"
2. "Vehicle status"
3. "Reset"

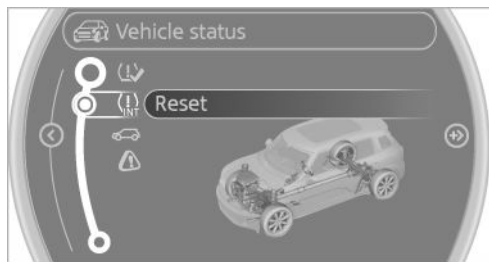

4. Start the engine, but do not start driving.
5. Start the initialization with "Reset".
6. Drive away.

The initialization is completed while driving, which can be interrupted at any time. The initialization automatically continues when driving resumes.

Indication of a flat tire

 The warning lights come on in yellow and red. A message appears on the Control Display. In addition, a signal sounds.

There is a flat tire or a major loss in tire inflation pressure.

1. Reduce your speed and stop cautiously. Avoid sudden braking and steering maneuvers.
2. Check whether the vehicle is fitted with regular tires or run-flat tires.

Run-flat tires, refer to page 226, are labeled with a circular symbol containing the letters RSC marked on the tire sidewall.

WARNING

A damaged regular tire with low or missing tire inflation pressure impacts handling, such as steering and braking response. Run-flat tires can maintain limited stability. There is risk of an accident. Do not continue driving if the vehicle is not equipped with run-flat tires. Follow the information on run-flat tires and continued driving with these tires. ◀

When a flat tire is indicated, DSC Dynamic Stability Control is switched on if necessary.

Actions in the event of a flat tire

Normal tires

1. Identify the damaged tire.

Do this by checking the inflation pressure in all four tires.

The tire pressure gauge of the Mobility System, refer to page 226, can be used for this purpose.

If the tire inflation pressure in all four tires is correct, the Flat Tire Monitor may not have been initialized. In this case, initialize the system.

If identification of flat tire damage is not possible, please contact a dealer's service center or another qualified service center or repair shop.

2. Rectify the flat tire using the Mobility System, refer to page 226.

Run-flat tires

You can continue driving with a damaged tire at speeds up to 50 mph/80 km/h.

Continued driving with a flat tire

If continuing to drive with a damaged tire:

1. Avoid sudden braking and steering maneuvers.
2. Do not exceed a speed of 50 mph/80 km/h.
3. At the next opportunity, check the inflation pressure in all four tires.

If the tire inflation pressure in all four tires is correct, the Flat Tire Monitor may not have been initialized. In this case, initialize the system.

Possible driving distance with complete loss of tire inflation pressure:

The possible driving distance after a loss of tire inflation pressure depends on the cargo load and the driving style and conditions.

For a vehicle containing an average load, the possible driving distance is approx. 50 miles/80 km.

When the vehicle is driven with a damaged tire, its handling characteristics change, e.g., reduced lane stability during braking, a longer braking distance, and altered self-steering properties. Adjust your driving style accordingly. Avoid abrupt steering maneuvers or driving over obstacles, e. g., curbs, potholes, etc.

Because the possible driving distance depends on how the vehicle is used during the trip, the actual distance may be smaller or greater depending on the driving speed, road conditions, external temperature, cargo load, etc.



WARNING

Your vehicle handles differently when a run-flat tire is damaged and has low or missing tire inflation pressure, e.g., your lane stability is reduced when braking, braking distances are longer and the self-steering properties will change. There is risk of an accident.

Drive moderately and do not exceed a speed of 50 mph/80 km/h. ◀

Final tire failure

Vibrations or loud noises while driving can indicate the final failure of a tire. Reduce speed and stop, otherwise, pieces of the tire could come loose and cause an accident. Do not continue driving. Contact a dealer's service center or another qualified service center or repair shop.

TIRE PRESSURE MONITOR TPM

The concept

The system monitors the tire pressure in the four mounted tires. The system notifies you if there is a significant loss of pressure in one or more tires. Sensors in the tire valves measure the tire pressure.

Information

To operate the system, also note the additional information and instructions contained under Tire inflation pressure, refer to page 218.

Functional requirements

The system must have been reset while the inflation pressure was correct; otherwise, it may not reliably signal a loss in pressure.

Perform a system reset after adjusting the tire inflation pressure to a new value and after changing a tire or wheel

Always use wheels with TPM electronics to ensure that the system will operate properly.

Status display

The current status of the Tire Pressure Monitor TPM can be displayed on the Control Display, e.g., whether or not the TPM is active.

1. "Vehicle Info"
2. "Vehicle status"
3. "Tire Pressure Monitor - TPM"

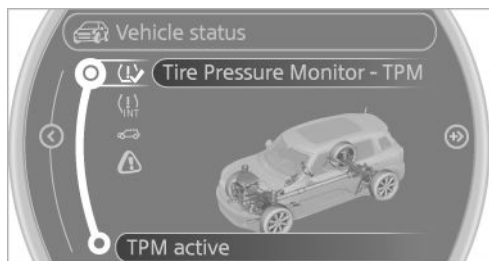

The status is displayed.

Status display

The tire and system status is indicated on the Control Display by the color of the tires and a text.

All wheels are green

The system is active and issues warnings based on the tire inflation pressures stored during the last reset.

One wheel is yellow

A flat tire or major drop in inflation pressure in the indicated tire.

All wheels are yellow

A flat tire or major drop in inflation pressure in several tires.

Wheels, gray

The system cannot detect a flat tire.

Reasons for this may be:

- ▷ The system is being reset.
- ▷ Malfunction.

Performing a reset

Perform a system reset after adjusting the tire inflation pressure to a new value and after changing a tire or wheel.

1. "Vehicle Info"
2. "Vehicle status"
3. "Reset"

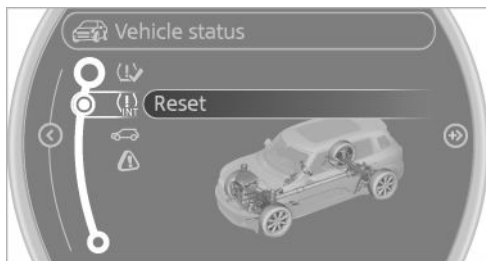

4. Start the engine - do not drive away.
5. Start the initialization with "Reset".
6. Drive away.

The wheels are shown in gray and the status is displayed.

After a short trip at over 20 mph/30 km/h, the set tire inflation pressures are adopted as target values. The reset is completed automatically as you drive.

After a successful reset, the wheels appear in green on the Control Display and "Status: TPM active" is displayed.

The trip can be interrupted at any time. When driving resumes, the reset is continued automatically.

Low tire pressure message



The warning lights come on in yellow and red. A Check Control message is displayed. A message is displayed on the onboard monitor. In addition, a signal sounds.



- ▶ There is a flat tire or substantial loss of inflation pressure on the indicated wheel.
 - ▶ The system was not reset after a wheel change and thus issues warnings based on the inflation pressures initialized last.
1. Reduce your speed and stop cautiously. Avoid sudden braking and steering maneuvers.
 2. Check whether the vehicle is fitted with regular tires or run-flat tires.

Run-flat tires, refer to page 226, are labeled on the tire sidewall with a circular symbol containing the letters RSC.



WARNING

A damaged regular tire with low or missing tire inflation pressure impacts handling, such as steering and braking response. Run-flat tires can maintain limited stability. There is risk of an accident. Do not continue driving if the vehicle is not equipped with run-flat tires. Follow the information on run-flat tires and continued driving with these tires. ◀

When a low inflation pressure is indicated, DSC Dynamic Stability Control is switched on if necessary.

Actions in the event of a flat tire

Normal tires

1. Identify the damaged tire.
Do this by checking the air pressure in all four tires. The tire pressure gauge of the Mobility System, refer to page 226, can be used for this purpose.

If the tire inflation pressure in all four tires is correct, the Tire Pressure Monitor may not have been reset. Reset the system.

If identification of flat tire damage is not possible, please contact a dealer's service center or another qualified service center or repair shop.

2. Rectify the flat tire using the Mobility System, refer to page 226.

Use of tire sealant, e.g., the Mobility System, may damage the TPM wheel electronics. In this case, have the electronics checked at the next opportunity and have them replaced if necessary.

Run-flat tires

You can continue driving with a damaged tire at speeds up to 50 mph/80 km/h.



WARNING

A damaged regular tire with low or missing tire inflation pressure impacts handling, such as steering and braking response. Run-flat tires can maintain limited stability. There is risk of an accident. Do not continue driving if the vehicle is not equipped with run-flat tires. Follow the information on run-flat tires and continued driving with these tires. ◀

Continued driving with a flat tire

If continuing to drive with a damaged tire:

1. Avoid sudden braking and steering maneuvers.
2. Do not exceed a speed of 50 mph/80 km/h.
3. Check the air pressure in all four tires at the next opportunity.

If the tire inflation pressure in all four tires is correct, the Tire Pressure Monitor may not have been reset. Reset the system.

Possible driving distance with complete loss of tire inflation pressure:

The possible driving distance after a loss of tire inflation pressure depends on the cargo load and the driving style and conditions.

For a vehicle containing an average load, the possible driving distance is approx. 50 miles/80 km.

When the vehicle is driven with a damaged tire, its handling characteristics change, e.g., reduced lane stability during braking, a longer braking distance, and altered self-steering properties. Adjust your driving style accordingly. Avoid abrupt steering maneuvers or driving over obstacles, e. g., curbs, potholes, etc.

Because the possible driving distance depends on how the vehicle is used during the trip, the actual distance may be smaller or greater depending on the driving speed, road conditions, external temperature, cargo load, etc.

WARNING

Your vehicle handles differently when a run-flat tire is damaged and has low or missing tire inflation pressure, e.g., your lane stability is reduced when braking, braking distances are longer and the self-steering properties will change. There is risk of an accident.

Drive moderately and do not exceed a speed of 50 mph/80 km/h. ◀

Final tire failure

Vibrations or loud noises while driving can indicate the final failure of the tire.

Reduce your speed and stop. Parts of tires can peel away, which could cause an accident.

Do not continue driving. Contact a dealer's service center or another qualified service center or repair shop.

Message indicating that the inflation pressure needs to be checked



The yellow warning light lights up.
A Check Control message is displayed.

An additional message is displayed on the on-board monitor.

- ▷ The system has detected that a wheel was changed but a reset was not performed.
- ▷ The tire was not inflated according to specifications.
- ▷ The tire pressure has dropped since the last confirmation.

In this case:

- ▷ Check the tire inflation pressure and correct it if necessary.
- ▷ After changing a wheel, reset the system.

System limits

The system will not function properly if a reset was not performed, e.g., it may identify a tire as flat although the tire is filled to the correct inflation pressure.

The tire pressure depends on the temperature of the tire. An increase in the tire temperature, e.g., while driving or due to sunlight, increases the tire inflation pressure. The tire pressure decreases when the tire temperature drops. In case of severe temperature drops, this behavior may lead to a warning on account of the defined warning limits.

The system cannot indicate sudden serious tire damage caused by external circumstances.

Malfunction



The yellow warning light flashes yellow and then lights up continuously.



A Check Control message is displayed.

An additional message is displayed on the onboard monitor.

A flat tire or tire inflation pressure loss cannot be detected.

Examples and recommendations in the following situations:

- ▷ A wheel without TPM electronics is mounted.

Have it checked by a dealer's service center or another qualified service center or repair shop as needed.

▷ **Malfunction:**

Have system checked by a dealer's service center or another qualified service center or repair shop.

 The yellow warning light flashes and then lights up continuously.

 A Check Control message is displayed.

An additional message is displayed on the onboard monitor.

A flat tire or tire inflation pressure loss cannot be detected.

Display in the following situation:

▷ **Disturbance by other systems or devices with the same radio frequency:**

After leaving the area of the disturbance, the system automatically becomes active again.

Declaration according to NHTSA/FMVSS 138 Tire Pressure Monitoring Systems

Each tire, including the spare (if provided) should be checked monthly when cold and inflated to the inflation pressure recommended by the vehicle manufacturer on the vehicle placard or tire inflation pressure label (If your vehicle has tires of a different size than the size indicated on the vehicle placard or tire inflation pressure label, you should determine the proper tire inflation pressure for those tires.).

As an added safety feature, your vehicle has been equipped with a tire pressure monitoring system (TPMS) that illuminates a low tire pressure telltale when one or more of your tires is significantly under-inflated. Accordingly, when the low tire pressure telltale illuminates, you should stop and check your tires as soon as possible, and inflate them to the proper pressure. Driving on a significantly under-inflated tire causes the tire to overheat and can lead to tire failure. Under-inflation also reduces fuel ef-

iciency and tire tread life, and may affect the vehicle's handling and stopping ability.

Please note that the TPMS is not a substitute for proper tire maintenance, and it is the driver's responsibility to maintain correct tire pressure, even if under-inflation has not reached the level to trigger illumination of the TPMS low tire pressure telltale.

Your vehicle has also been equipped with a TPMS malfunction indicator to indicate when the system is not operating properly. The TPMS malfunction indicator is combined with the low tire pressure telltale. When the system detects a malfunction, the telltale will flash for approximately one minute and then remain continuously illuminated. This sequence will continue upon subsequent vehicle startups as long as the malfunction exists. When the malfunction indicator is illuminated, the system may not be able to detect or signal low tire pressure as intended. TPMS malfunctions may occur for a variety of reasons, including the installation of replacement or alternate tires or wheels on the vehicle that prevent the TPMS from functioning properly. Always check the TPMS malfunction telltale after replacing one or more tires or wheels on your vehicle to ensure that the replacement or alternate tires and wheels allow the TPMS to continue to function properly.

SPEED LIMIT

The concept

Enter a speed for which a Check Control message will be displayed when the speed is reached. This enables you to receive warnings if you exceed a speed limit in an urban area, for example.

You are only warned of reaching this speed a second time if your vehicle speed falls below it again by at least 3 mph/5 km/h.

Displaying, setting or changing the limit

1. "Settings"
2. "Speed"
3. "Warning at:"

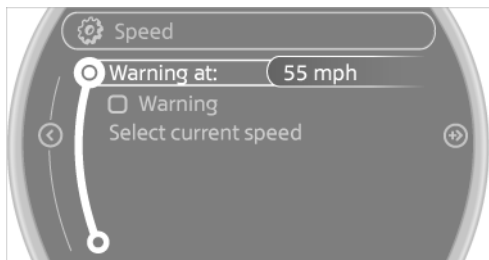

4. Turn the MINI joystick to accept the setting.
5. Press the MINI joystick to apply the setting.
The limit is stored.

Applying your current speed as the limit

1. "Settings"
2. "Speed"
3. "Select current speed"

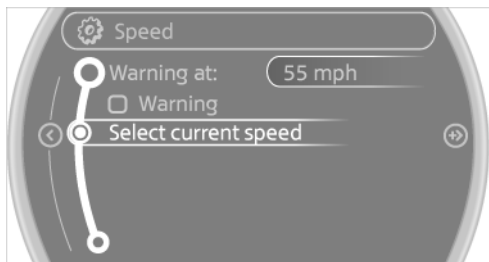

4. Press the MINI joystick.

The system adopts your current speed as the limit.

Activating/deactivating the limit

1. "Settings"
2. "Speed"

3. "Warning"

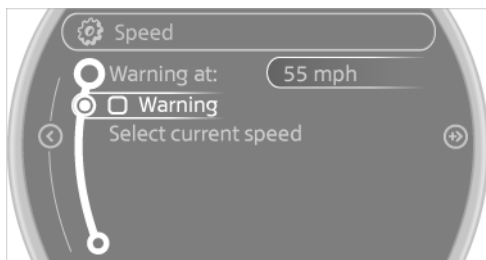

4. Press the MINI joystick.

DRIVING STABILITY CONTROL SYSTEMS

VEHICLE FEATURES AND OPTIONS

This chapter describes all standard, country-specific and optional features offered with the series. It also describes features that are not necessarily available in your car, e. g., due to the selected options or country versions. This also applies to safety-related functions and systems.

When using the features and systems described here, adhere to local regulations.

ANTILOCK BRAKE SYSTEM ABS

ABS prevents locking of the wheels during braking.

Steerability is maintained even during full braking. This increases active driving safety.

ABS is operational every time you start the engine.

Electronic brake-force distribution EBV

The system controls the brake pressure in the rear wheels to ensure stable braking behavior.

CBC Cornering Brake Control

When braking in curves or during a lane change, driving stability and steering response are improved further.

BRAKE ASSISTANT

When the brakes are applied rapidly, this system automatically produces the maximum braking force boost. In this way, the system helps keep the braking distance as short as

possible. This system utilizes all of the benefits provided by ABS.

Do not reduce the pressure on the brake pedal for the duration of full braking.

DYNAMIC STABILITY CONTROL DSC

The concept

DSC prevents traction loss in the driving wheels when driving away and accelerating.

DSC also recognizes unstable vehicle conditions, such as fishtailing or nose-diving. Subject to physical limits, DSC helps to keep the vehicle on a steady course by reducing engine speed and by applying brakes to the individual wheels.

Adapt your driving style to the situation, for an appropriate driving style is always the responsibility of the driver.

DSC is operational every time you start the engine.



WARNING

When driving with roof load, e.g. with roof-mounted luggage rack, driving safety may not be ensured in driving-critical situations due to the elevated center of gravity. There is risk of accidents or risk of property damage. Do not deactivate Dynamic Stability Control DSC when driving with roof load. ◀

Deactivating DSC

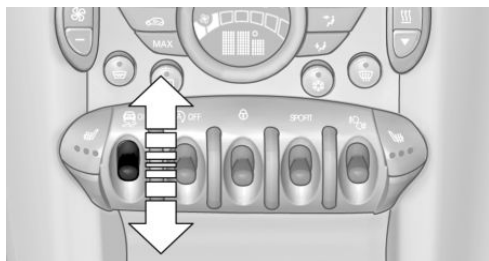

Press the switch until the DSC OFF indicator lamp lights up in the speedometer and DSC OFF appears in the tachometer. DSC is deactivated. Intervening measures to stabilize the vehicle and give it forward momentum are no longer executed.

When driving with snow chains or to rock the vehicle free of snow, it may be useful to deactivate DSC temporarily.

To increase vehicle stability, activate DSC again as soon as possible.

Activating DSC

Press the switch again; the DSC indicator lamps in the display elements go out.

Indicator/warning lights



The indicator lamp in the tachometer flashes: DSC is controlling the drive forces and brake forces.

The indicator lamp lights up: DSC and DTC has failed.



The indicator lamp in the speedometer lights up and DSC OFF appears in the tachometer.

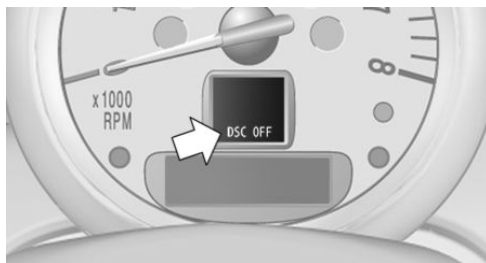

DSC and DTC deactivated.

DYNAMIC TRACTION CONTROL DTC

The concept

The DTC system is a version of the DSC in which forward momentum is optimized.

The system ensures maximum forward momentum on special road conditions, e.g., unplowed snowy roads, but driving stability is limited.

It is therefore necessary to drive with appropriate caution.

You may find it useful to briefly activate DTC under the following special circumstances:

- ▷ When driving in sand, on snowy inclines, in slush, or on unplowed, snow-covered road surfaces.
- ▷ When rocking a vehicle free or starting off in deep snow, sand, or on loose ground.
- ▷ When driving with snow chains.

Activating DTC

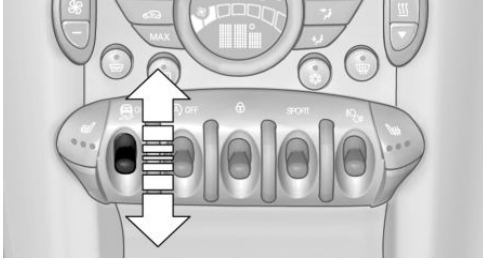

Press the switch; the DSC OFF indicator lamp lights up in the speedometer and TRACTION appears in the tachometer. Dynamic Stability Control DSC is deactivated, Dynamic Traction Control DTC is activated.

Deactivating DTC

Press the switch again; the DSC OFF indicator lamp in the speedometer and TRACTION in the tachometer go out.

In the interest of better forward momentum, brake intervention is performed in the manner of a differential lock when the drive wheels spin unevenly even when DSC/DTC is deactivated.

Indicator/warning lights



The indicator lamp in the tachometer flashes: DTC is controlling the drive forces and brake forces.

The indicator lamp lights up: DSC and DTC has failed.



The indicator lamp in the speedometer lights up and TRACTION appears in the tachometer.

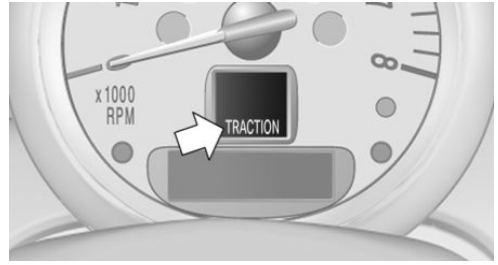

DTC is activated.

HILL DRIVE-OFF ASSISTANT

This system supports driving away on gradients. The parking brake is not required.

1. Hold the vehicle in place with the foot brake.
2. Release the foot brake and drive away without delay.

After the foot brake is released, the vehicle is held in place for approx. 2 seconds.

ALL4 ALL-WHEEL SYSTEM

ALL4 is the all-wheel system of your MINI. The combined effects of ALL4 and DSC further optimize the traction and dynamic driving characteristics. The ALL4 all-wheel system variably distributes the drive forces to the front and rear axles depending on the driving situation and prevailing road conditions.

SPORT BUTTON

When this button is pressed, the vehicle responds in an even sportier manner.

- ▷ The engine responds more spontaneously to accelerator movements.
- ▷ The steering responds more directly.
- ▷ Cooper S, John Cooper Works: the engine sounds sportier when coasting.

- ▷ For Steptronic transmissions: more rapid gear changes in the Sport program.

Activating the system

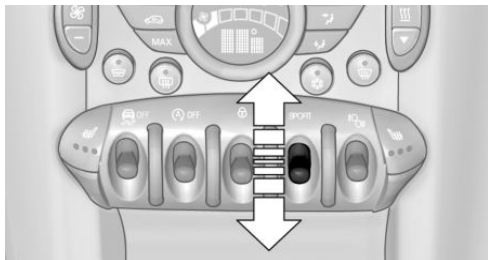

Press the switch; the LED in the button lights up and SPORT is displayed briefly in the tachometer.

Deactivating the system

- ▷ Press the switch again.
- ▷ Switch the engine off.

DRIVING COMFORT

VEHICLE FEATURES AND OPTIONS

This chapter describes all standard, country-specific and optional features offered with the series. It also describes features that are not necessarily available in your car, e. g., due to the selected options or country versions. This also applies to safety-related functions and systems.

When using the features and systems described here, adhere to local regulations.

CRUISE CONTROL

The concept

The system is functional at speeds beginning at approx. 20 mph/30 km/h.

The vehicle stores and maintains the speed specified using the controls on the steering wheel.



WARNING

The use of the system can lead to an increased risk of accidents in the following situations:

- ▷ On winding roads.
- ▷ In heavy traffic.
- ▷ On slippery roads, in fog, snow or rain, or on a loose road surface.

There is risk of accidents or risk of property damage. Only use the system if driving at constant speed is possible. ◀

Controls

Overview

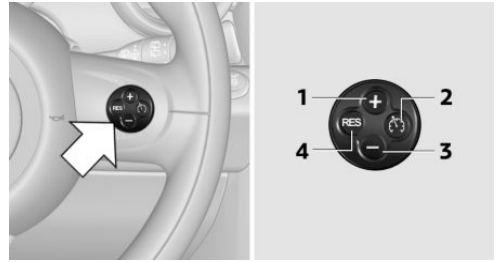

- 1 Maintaining, storing, and increasing the speed
- 2 Activating/deactivating cruise control
- 3 Maintaining, storing, and reducing the speed
- 4 Resuming cruise control

Switching on

Press button 2.



The indicator lamp lights up in the speedometer. Cruise control is ready to operate and can be activated.

Switch off



WARNING

The system does not relieve from the personal responsibility to correctly assess the traffic situation. Based on the limits of the system, it cannot independently react to all traffic situations. There is risk of an accident. Adjust the driving style to the traffic conditions. Watch traffic closely and actively interfere in the respective situations. ◀

Press button 2.

- ▷ When activated: press twice.
- ▷ When interrupted: press once.

The displays go out. The stored target speed is cleared.

Interrupting

Press button 2.

The system is interrupted automatically if

- ▷ The brakes are applied.
- ▷ The clutch pedal is depressed.
- ▷ The transmission position D is disengaged.
- ▷ DSC intervenes.

Maintaining, storing the current speed

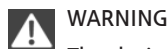

WARNING

The desired speed can be incorrectly adjusted or called up by mistake. There is risk of an accident. Adjust the desired speed to the traffic conditions. Watch traffic closely and actively interfere in the respective situations. ◀

Press button 1 or button 3.

The current speed is maintained and stored. It is displayed briefly in the tachometer.

On downhill gradients, it may prove impossible to maintain the set speed if the engine braking power is insufficient. On uphill gradients, it may prove impossible to maintain the set speed if the engine power output is insufficient.

Increasing speed

- ▷ Press button 1 repeatedly until the desired speed is reached.

Each time the button is pressed, the speed increases by approx. 1 mph/1 km/h.

- ▷ Press and hold button 1 until the desired speed is reached.

The vehicle accelerates without pressure on the accelerator pedal. After the button is released, the achieved speed is maintained and stored.

Decreasing speed

Press button 3 repeatedly or hold it until the desired speed is reached.

The functions are the same those when the speed is increased, only that the speed is reduced.

Resuming a speed stored beforehand

Press button 4.

The last stored speed is resumed and maintained.

The stored speed is cleared when the ignition is switched off.

Display in the tachometer

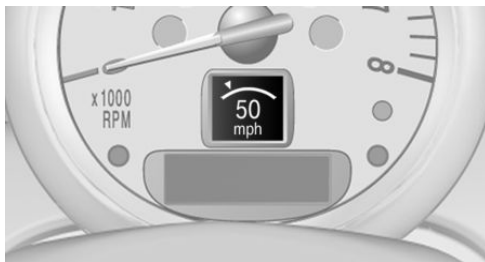

The selected speed is displayed briefly.

If the display --- mph or --- km/h appears briefly, conditions may not be adequate to operate the system.

For better control



The indicator lamp lights up in the speedometer. Cruise control is ready to operate and can be activated.

Malfunction



The warning lamp in the tachometer lights up.

A message appears on the Control Display.

The system is malfunctioning or has failed.

PARK DISTANCE CONTROL PDC

The concept

PDC provides support when parking in reverse. Signal tones and a visual display indicate that the vehicle is approaching an object behind it. Measurements are made by four ultrasound sensors in the bumpers.

The range of these sensors is approx. 6 ft/2 m.

An acoustic warning is first given:

- ▷ By the two corner sensors at approx. 24 in/60 cm.
- ▷ By the rear middle sensors at approx. 5 ft/1.50 m.



WARNING

Due to high speeds when PDC is activated, the warning can be delayed due to physical circumstances. There is risk of injuries or risk of property damage. Avoid approaching an object quickly. Avoid driving away quickly while PDC is not yet active. ◀

Automatic operation

The system is activated after approx. one second when reverse gear or selector lever position R is engaged while the engine is running or the ignition is switched on. Await this short period before setting the vehicle into motion.

Signal tones

The closer the vehicle is to the object, the shorter the intervals become. If the distance to a detected object is less than approx.

12 in/30 cm, a continuous tone is sounded.

If the distance remains constant, for example when driving parallel to a wall, the signal tone is stopped after approx. 3 seconds.

PDC with visual warning

Displaying the approach to an object on the Control Display. The contours of distant objects

are displayed on the Control Display before a signal tone is output. The display is shown on the Control Display as soon as reverse gear or selector lever position R is engaged.

System limits



WARNING

The system does not relieve from the personal responsibility to correctly assess the traffic situation. There is risk of an accident. Adjust the driving style to the traffic conditions. Watch traffic and vehicle surroundings closely and actively interfere in the respective situations. ◀

Malfunction



The warning light lights up. A message appears on the Control Display. PDC is malfunctioning or has failed. Have the system checked.

To ensure full functionality of the sensors, keep the sensors clean and free of ice. When using high-pressure washers, do not spray the sensors for long periods and maintain a distance of at least 12 in/30 cm.

CLIMATE

VEHICLE FEATURES AND OPTIONS

This chapter describes all standard, country-specific and optional features offered with the series. It also describes features that are not

necessarily available in your car, e. g., due to the selected options or country versions. This also applies to safety-related functions and systems.

When using the features and systems described here, adhere to local regulations.

AIR CONDITIONER

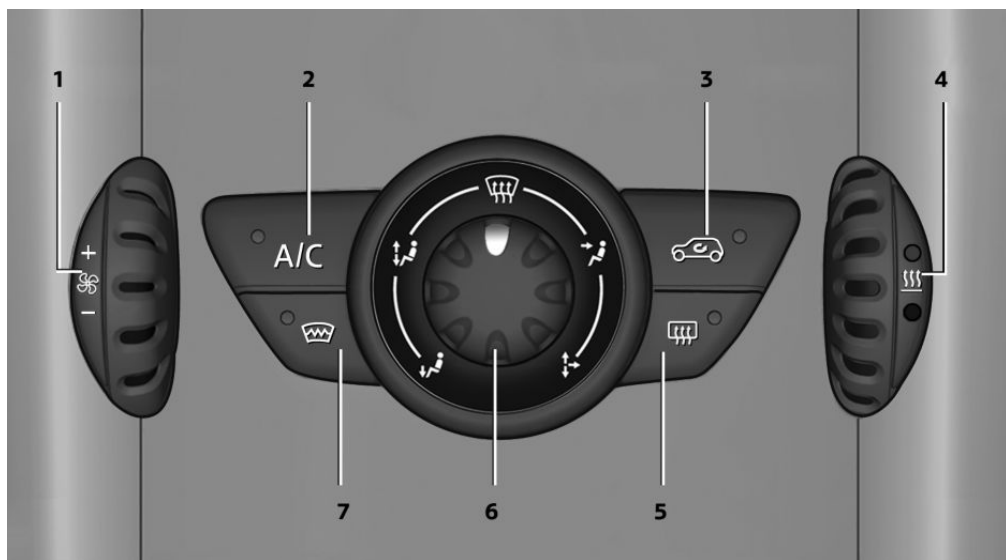

- | | | | |
|---|-----------------------|---|-----------------------|
| 1 | Air volume | 5 | Rear window defroster |
| 2 | Cooling function | 6 | Vent settings |
| 3 | Recirculated air mode | 7 | Windshield heating |
| 4 | Temperature | | |

Air volume



Vary the air volume. The higher the rate, the more effective the heating or cooling will be.

The air flow rate may be reduced or the blower may be switched off entirely to save on battery power.

Switching the system on/off

Turn the rotary switch for the air volume to 0. The blower and air conditioner are completely switched off and the air supply is cut off.

Set any air volume to switch on the air conditioning.

Cooling function



The car's interior can only be cooled with the engine running.

The cooling function cools and dehumidifies the incoming air before reheating it as required,

according to the temperature setting.

The cooling function helps to prevent condensation on the windows or to remove it quickly.

Depending on the weather, the windshield may fog up briefly when the engine is started.

To cool the air faster and more intensively when external temperatures are high, switch on the recirculated air mode.

Recirculated air mode



If the air outside the car has an unpleasant odor or contains pollutants, shut off the supply to the interior of the car temporarily.

The system then recirculates the air currently within the vehicle.

Should the windows fog up in the recirculated-air mode, press the AUTO button or switch off the recirculated-air mode and increase the air volume if necessary. Make sure that air can flow to the windshield.

Recirculated air mode is automatically deactivated at low external temperatures.

With constant recirculated-air mode, the air quality in the car's interior deteriorates and the fogging of the windows increases.

Temperature



Turn upward, red, to raise the temperature.

Turn downward, blue, to lower the temperature.

Rear window defroster





The rear window defroster switches off automatically after a certain period of time.

The rear window defroster power may be lowered or even switched off entirely to save on battery power.

Vent settings



Direct the flow of air to the windows , to the upper body area , or to the footwell . Intermediate positions are possible.

Windshield heating



The windshield heating switches off automatically after some time.

The windshield heating may be reduced or even switched off entirely to save on battery power.

Defrosting and defogging windows

1. Set the maximum air volume.
2. Air distribution in position .

By switching on the cooling function, the windows are defogged more rapidly.
3. Set the highest temperature, red.
4. Deactivate recirculated air mode.
5. Switch on the windshield heating if necessary.
6. Switch on the rear window defroster if necessary.

Microfilter

The microfilter traps dust and pollen. The microfilter should be changed during maintenance of your vehicle.

Microfilter/activated-charcoal filter

The microfilter traps dust and pollen. The activated-charcoal filter provides additional protec-

tion by filtering gaseous pollutants from the outside air. The combined filter should be changed during maintenance of your vehicle.

AUTOMATIC CLIMATE CONTROL

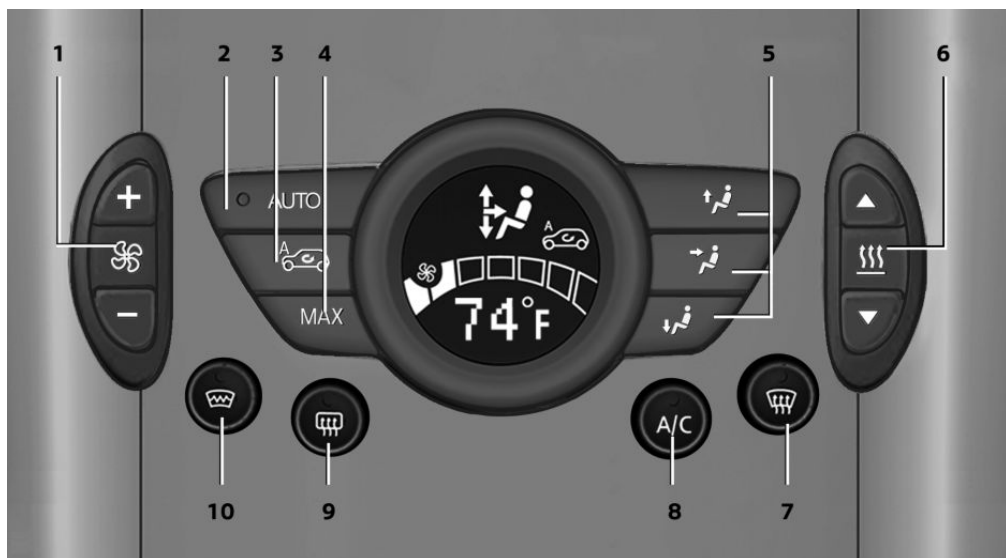

- | | |
|--|--|
| <ul style="list-style-type: none"> 1 Air flow, manual 2 AUTO program 3 Recirculated air mode 4 Maximum cooling 5 Manual air distribution 6 Temperature | <ul style="list-style-type: none"> 7 Defrosting windows and removing condensation 8 Cooling function 9 Rear window defroster 10 Windshield heating |
|--|--|

Comfortable interior climate

The AUTO program offers the optimum air distribution and air volume for virtually all conditions, refer to AUTO program below. Select a comfortable interior temperature only.

The following sections contain more detailed information on the available setting options. Most of these settings are stored for the remote control in use, Personal Profile settings, refer to page 31.

Air flow, manual



Press the – button to reduce the air volume. Press the + button to increase the air volume.

The automatic mode for the air volume can be switched on again using the AUTO button.

The air flow rate may be reduced or the blower may be switched off entirely to save on battery power. The display remains the same.

Switching the system on/off

Reduce the air volume by pressing the – button until the system is switched off. All displays go out.

Press the AUTO button to switch the automatic climate control back on.

AUTO program



The AUTO program automatically adjusts the air distribution to the windshield and side windows, toward the upper body area, and into the footwell. The

air volume and your specifications for the temperature are adjusted to outside influences due to the seasons, e. g., solar radiation.

The cooling function is switched on automatically with the AUTO program.

The program is switched off if the air distribution is manually adjusted or the button is pressed again.

Recirculated air mode



If the air outside the car has an unpleasant odor or contains pollutants, shut off the supply to the interior of the car temporarily.

The system then recirculates the air currently within the vehicle.

Should the windows fog up in the recirculated-air mode, press the AUTO button or switch off

the recirculated-air mode and increase the air volume if necessary. Make sure that air can flow to the windshield.

Recirculated air mode is automatically deactivated at low external temperatures.

With constant recirculated-air mode, the air quality in the car's interior deteriorates and the fogging of the windows increases.

Maximum cooling



Automatic climate control switches to the lowest temperature, a high air volume, and recirculated air mode.

For maximum cooling, open the vents for the upper body area.

The air is cooled as quickly as possible:

- ▷ At an external temperature above 32 °F/0 °C.
- ▷ When the engine is running.

Manual air distribution



The flow of air is directed, as selected, to the windows, to the upper body area, or to the footwell.

The automatic mode for the air distribution can be switched back on using the AUTO button.

Temperature



Set the desired temperature individually.

The automatic climate control achieves this temperature as quickly as possible regardless of the season, using maximum cooling or heating power if necessary, and then maintains it.

When switching between different temperature settings in rapid succession, the automatic cli-

mate control does not have sufficient time to adjust the set temperature.

Rear window defroster



The rear window defroster switches off automatically after a certain period of time.

Depending on the vehicle equipment, upper wires are used as an antenna and are not part of the rear window defroster.

Defrosting and defogging windows



Quickly removes ice and condensation from the windshield and front side windows. For this purpose, also switch on the cooling function.

The windshield heating switches on automatically.

Windshield heating



The windshield heating switches off automatically after some time.

Cooling function



The cooling function cools and dehumidifies the incoming air before reheating it as required, according to the temperature setting. The car's interior can

only be cooled with the engine running.

The cooling function helps to prevent condensation on the windows or to remove it quickly.

Depending on the weather, the windshield may fog up briefly when the engine is started. Recirculated air mode is switched on automatically if necessary.

The cooling function is switched on automatically when the AUTO button is pressed.

Microfilter/activated-charcoal filter

The microfilter traps dust and pollen. The activated-charcoal filter provides additional protection by filtering gaseous pollutants from the outside air. The combined filter should be changed during maintenance of your vehicle.

VENTILATION

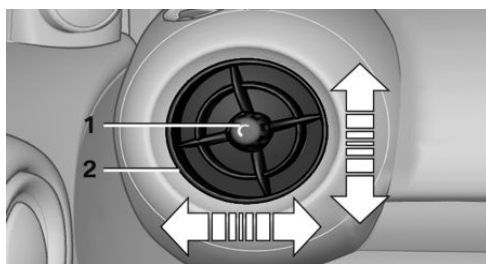

- 1 Knob for continuous opening and closing
- 2 Nozzle for direction of air flow

Opening/closing

Turn the knob.

Direction of air flow

Pivot the entire nozzle.

INTERIOR EQUIPMENT

VEHICLE FEATURES AND OPTIONS

This chapter describes all standard, country-specific and optional features offered with the series. It also describes features that are not necessarily available in your car, e. g., due to the selected options or country versions. This also applies to safety-related functions and systems.

When using the features and systems described here, adhere to local regulations.

UNIVERSAL GARAGE DOOR OPENER

The concept

The universal garage door opener can be used to operate up to 3 functions in remote-controlled systems, such as garage door drives or lighting systems. The universal garage door opener replaces up to 3 different hand-held transmitters. To operate it, the buttons on the interior rearview mirror must be programmed for the desired functions. The hand-held transmitter for the system is needed for the programming procedure.

WARNING

Body parts can be jammed when operating remote-controlled systems, e.g. the garage door, using the universal garage door opener. There is risk of injuries or risk of property damage. Make sure that the area of movement of the respective system is clear during programming and operation. Also follow the safety instructions of the hand-held transmitter. ◀

Before selling the vehicle, delete the stored functions for security reasons.

Compatibility



If this symbol is printed on the packaging or in the operating instructions of the system being operated, the system is generally compatible with the universal garage door opener.

If you have any questions, please contact:

- ▷ A dealer's service center or another qualified service center or repair shop.
- ▷ www.homelink.com on the Internet.

HomeLink is a registered trademark of the Gentex Corporation.

Controls on the interior rearview mirror

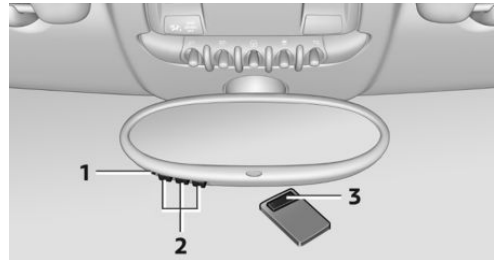

- 1 LED
- 2 Buttons
- 3 Hand-held transmitter, required for programming.

Programming

General information

1. Switch on the ignition.
2. Initial setup:

Press the right and left buttons on the interior rearview mirror simultaneously for approx. 20 seconds until the LED on the interior rearview mirror begins to flash. All

programmed settings of the buttons on the interior rearview mirror are deleted.

3. Hold the hand-held transmitter of the system to be operated a distance of approx. 1 to 3 in/2.5 to 8 cm away from the buttons on the interior rearview mirror. The required distance depends on the particular hand-held transmitter.
4. Press the button of the desired function on the hand-held transmitter and the button being programmed on the interior rearview mirror simultaneously and hold. The LED on the interior rearview mirror flashes slowly at first.
5. When the LED flashes more rapidly, release both buttons. Rapid flashing indicates that the button on the interior rearview mirror has been programmed.

If the LED does not flash faster after 60 seconds, change the distance between the interior rearview mirror and the hand-held transmitter and repeat the step. Multiple trials at different distances may be necessary. Wait at least 15 seconds between trials.

6. To program additional functions on other buttons, repeat steps 3 to 5.

The systems can be operated with the buttons on the interior rearview mirror.

Special characteristics of alternating-code radio systems

If the system cannot be operated after repeated programming, check whether the system to be operated uses an alternating-code system.

Read the operating instructions of the system or press and hold the programmed button on the interior rearview mirror. If the LED on the interior rearview mirror flashes rapidly at first and then lights up continuously for 2 seconds, the system is equipped with an alternating-code system. This flashing LED pattern repeats itself for approx. 20 seconds.

In systems with an alternating-code system, the universal garage door opener and the system must be additionally synchronized.

Please obtain additional information on synchronization in the operating instructions of the system being set up.

The systems will be easier to synchronize with the aid of a second person.

Synchronization:

1. Park the vehicle within range of the remote-controlled system.
2. Program the corresponding button on the interior rearview mirror as described.
3. Identify and press the synchronization button on the system being set up. You have approx. 30 seconds for the next step.
4. Press and hold the button on the interior rearview mirror for approx. 3 seconds and then release it. Repeat this step up to three times if necessary to complete the synchronization procedure. When synchronization is completed, the programmed function is executed.

Reprogramming individual buttons

1. Switch on the ignition.
2. Hold the hand-held transmitter at a distance of approx. 1 to 3 in/2.5 to 8 cm from the memory buttons.

The required distance depends on the particular hand-held transmitter.

3. Press the memory button of the universal garage door opener.
4. If the LED flashes slowly after approx. 20 seconds, press the transmit button on the hand-held transmitter.
5. Release both buttons when the LED flashes rapidly.

If the LED does not flash rapidly after approx. 60 seconds, change the distance and repeat the step.

Canada: if the LED does not flash rapidly after approx. 60 seconds, change the distance and repeat the step. If programming was aborted by the hand-held transmitter, hold down the memory button and press and release the button on the hand-held transmitter several times for 2 seconds.

Controls



WARNING

Body parts can be jammed when operating remote-controlled systems, e.g. the garage door, using the universal garage door opener. There is risk of injuries or risk of property damage. Make sure that the area of movement of the respective system is clear during programming and operation. Also follow the safety instructions of the hand-held transmitter. ◀

The system, such as the garage door, can be operated using the button on the interior rearview mirror with the engine running or the ignition switched on. When you are within the reception range of the system, press and hold the button until the function is initiated. The LED on the interior rearview mirror lights up continuously while the radio signal is being transmitted.

Deleting stored functions

Press the right and left buttons on the interior rearview mirror simultaneously for approx. 20 seconds until the LED flashes rapidly. All stored functions are deleted. The functions cannot be deleted individually.

SUN VISOR

Glare protection

Folding down

Fold the sun visor down.

Folding up

Fold the sun visor up.

Glare protection from the side

Folding down

1. Fold the sun visor down.
2. Detach from the holder and pivot sideways to the side window.

Folding up

To close the sun visor, proceed in reverse order.

Vanity mirror

A vanity mirror is located behind a cover on each sun visor.

To open, fold the cover up.

Depending on the vehicle equipment, mirror lighting comes on when the cover is opened.

DIGITAL COMPASS

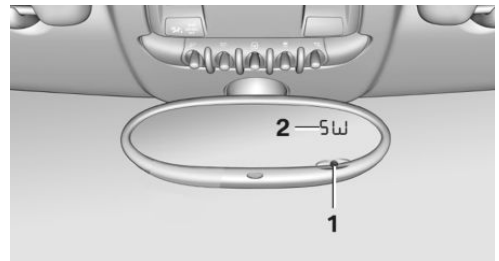

- 1 Adjustment button on the back of the mirror
- 2 Display

The display shows the main or secondary compass direction in which the vehicle is traveling.

Operating concept

Various functions can be called up by pressing the adjustment button with a pointed object such as a pen. The following adjustment options are displayed one after the other, de-

pending on how long the adjustment button is pressed:

- ▷ Press briefly: switch the display on/off.
- ▷ 3 to 6 seconds: set the compass zone.
- ▷ 6 to 9 seconds: calibrate the compass.
- ▷ 9 to 12 seconds: set left-hand/right hand steering.

- ▷ 12 to 15 seconds: set the language.

Setting compass zones

Set the compass zone corresponding to the vehicle's geographic location so that the compass can function correctly; refer to the world map with compass zones.

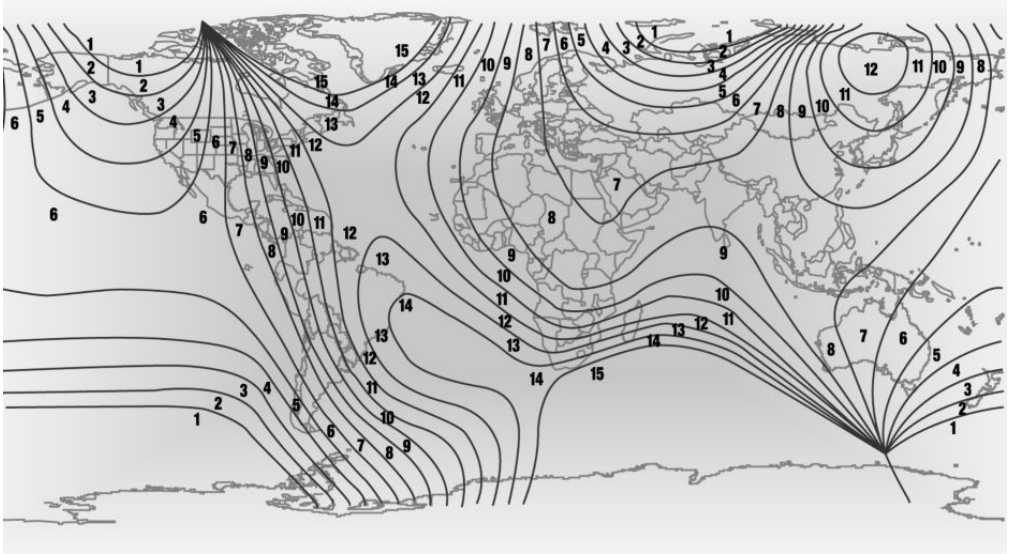

Press the adjustment button for 3-4 seconds. The number of the compass zone set is shown in the display.

To change the zone setting, briefly press the adjustment button repeatedly until the display shows the number of the compass zone corresponding to the current location.

The compass is operational again after approx. 10 seconds.

Calibrating the digital compass

The digital compass must be calibrated in the following situations:

- ▷ An incorrect compass direction is shown.

- ▷ The cardinal direction displayed does not change even if the direction of travel changes.
- ▷ Not all compass directions are shown.

Procedure

1. Make sure that there are no large metal objects or overhead power lines in the vicinity of the vehicle and that there is enough space to drive in a circle.
2. Set the currently valid compass zone.
3. Press the adjustment button for 6-7 seconds to call up C. Then drive at least one full circle at a maximum speed of 4 mph/7 km/h. When the system is calibrated, the C is replaced by the compass directions.

Right-hand/left-hand steering

The digital compass is set for right-hand or left-hand steering at the factory.

Setting the language

Press the adjustment button for 12-13 seconds. Briefly press the adjustment button again to switch between English "E" and German "O".

The setting is automatically saved after approx. 10 seconds.

CUPHOLDERS AND ASHTRAY/LIGHTER



Cupholders

Two cupholders are located in the center console in the front.

MINI Countryman: two additional cupholders are located at the end of the center console in the rear. Additional cupholders can be installed on the center rail.

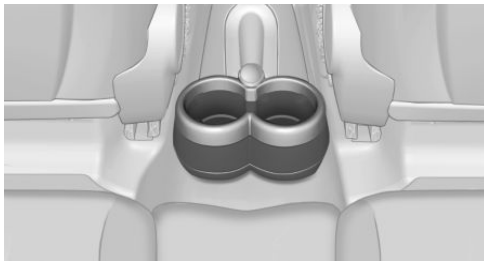

MINI Paceman: additional cupholders are located in the console between the rear seats.



Depending on the equipment, additional cupholders can be installed on the center rail.



WARNING

Unsuitable containers in the cup holder and hot beverages can damage the cup holder and increase the risk of injuries in the event of an accident. There is risk of injuries or risk of property damage. Use light-weight, unbreakable, and sealable containers. Do not transport hot beverages. Do not force objects into the cup holder. ◀

Ashtray

The ashtray is located in one of the cupholders in the center console at the front.

Emptying

Take out the entire ashtray, arrow.

When installing, ensure that the ashtray is inserted in the cupholder with the adapter.

Lighter

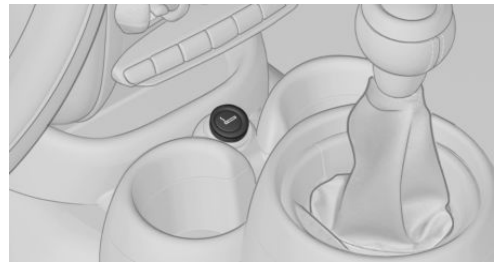

With the engine running or the ignition switched on, press in the cigarette lighter.

The lighter can be removed as soon as it pops back out.

WARNING

Contact with hot heating elements or the hot socket of the cigarette lighter can cause burns. Flammable materials can ignite if the cigarette lighter falls down or is held against the respective objects. There is risk of fire and injuries. Hold the cigarette lighter on its handle. Make sure that children do not use the cigarette lighter and do not burn themselves, e.g. by carrying the remote control along when exiting the vehicle. ◀

CONNECTING ELECTRICAL DEVICES

The lighter socket can be used as a socket for electrical equipment while the engine is running or when the ignition is switched on. The total load of all sockets must not exceed 140 watts at 12 volt.

Avoid damaging the sockets by attempting to insert plugs of unsuitable shape or size.

CAUTION

Battery chargers for the vehicle battery can work with high voltages and currents, which means that the 12V on-board network can be overloaded or damaged. There is risk of property damage. Only connect battery chargers for the vehicle battery to the starting aid terminals in the engine compartment. ◀

CAUTION

If metal objects fall into the socket, they can cause a short circuit. There is risk of property damage. Replace the cigarette lighter or socket cover again after using the socket. ◀

Socket in the center console

Remove the cover or lighter, refer to page 109, from the socket.

Socket in the rear

MINI Countryman

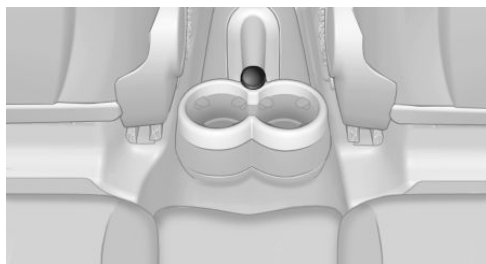

Take out the cover.

MINI Paceman

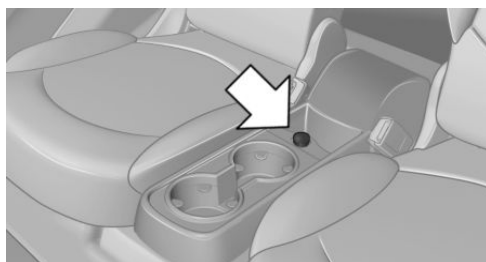

Take out the cover.

Socket in the cargo area

MINI Countryman

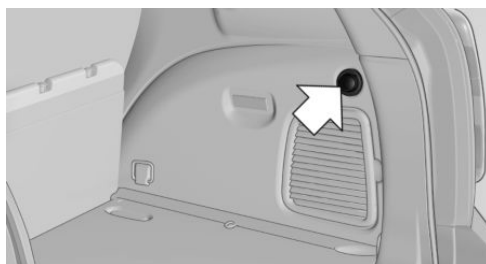

Take out the cover.

MINI Paceman

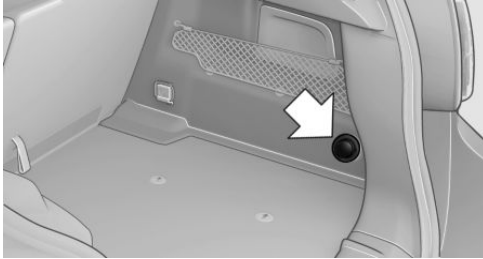

Take out the cover.

CARGO AREA

Cargo cover

⚠ WARNING

Loose objects in the car's interior can be thrown into the car's interior while driving, e.g. in the event of an accident or during braking and evasive maneuvers. There is risk of injuries. Secure loose objects in the car's interior. ◀

When the tailgate is opened, the cargo cover is raised.

When closing, ensure that the cargo cover is resting on the rubber buffers of the securing straps; otherwise, damage may occur when closing the tailgate.

To load bulky luggage, the cover can be removed.

1. Detach the securing straps from the tailgate.
2. Lift the cover slightly, arrow 1, and pull it back and out of the bracket, arrow 2.

MINI Countryman:

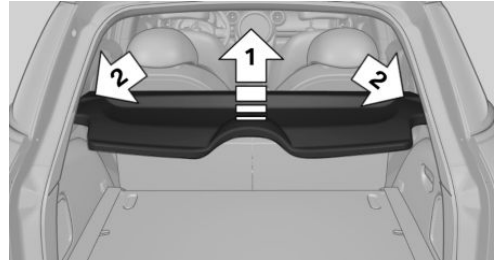

MINI Paceman:

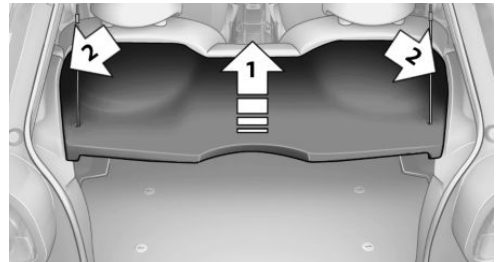

MINI Countryman: rear seat backrests

Observe the instructions concerning the safety belt, refer to page 46. Otherwise, personal protection may be compromised.

⚠ WARNING

Danger of jamming with folding down the backrests. There is risk of injuries or risk of property damage. Make sure that the area of movement of the rear backrest is clear prior to folding down. ◀

The rear seat backrest is divided at a ratio of 40-20-40.

When the outer rear seat backrests are folded down, it is not permissible for a person to travel on the center seat.

Remove the third head restraint, refer to page 50, if necessary.

Open the center safety belt and insert it in the belt holder on the headliner, refer to page 48.

Enlarge the cargo area by adjusting the rear seat backrests to a more upright position.

The backrests can be adjusted to 10 different positions between the comfort and transport positions and they can be folded down.

In the comfort position, the backrests are tilted back to the greatest possible angle and in the transport position they are nearly vertical.

Before beginning with the mounting of a child restraint fixing system, note the instructions, refer to page 53.

1. Hold the top of the backrest, for example the head restraint, and pull on the loop, arrow.

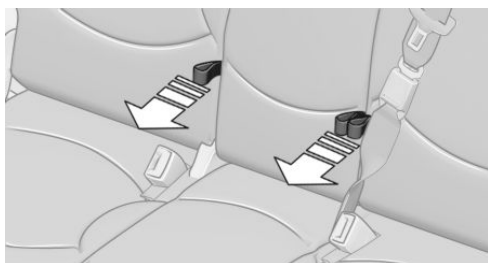

2. Engage the backrest in the desired position or fold it down.

Folding the backrests back up

WARNING

With an unlocked backrest, an unsecured load can be thrown into the car's interior, e.g. in case of an accident, braking or evasive maneuver. There is risk of injuries. Make sure that the backrest engages into the locking after folding it back. ◀

WARNING

The stability of the child restraint system is limited or compromised with incorrect seat adjustment or improper installation of the child seat. There is risk of injuries or danger to life. Make sure that the child restraint system fits securely against the backrest. If possible, adjust the backrest tilt for all affected backrests and correctly adjust the seats. Make sure that seats and backrests are securely engaged. If possible,

adjust the height of the head restraints or remove them. ◀

When the backrests are folded back up, they engage in the transport position.

To set the desired backrest inclination or comfort position, hold the backrest, pull the loop forward, and adjust the backrest.

MINI Paceman: rear seat backrests

1. Fold the belt buckles down.

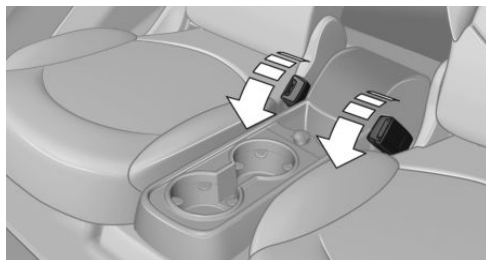

2. Pull on the respective loop, arrow. The backrest is unlocked.

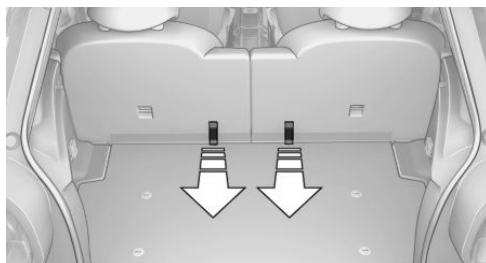

3. Fold the backrest forward.

Folding the backrests back up

Hold the top of the backrest, for example the head restraint, and fold it back.

WARNING

With an unlocked backrest, an unsecured load can be thrown into the car's interior, e.g. in case of an accident, braking or evasive maneuver. There is risk of injuries. Make sure that the backrest engages into the locking after folding it back. ◀

Flat loading floor

The maximum load on the loading floor is:
330 lbs, 150 kg.

Access to storage area

A storage area for items like the partition net is found under the loading floor.

1. Reach into the recess, arrow 1, on the rear edge of the loading floor.
2. Lift the loading floor at the rear, arrow 1, and fold it forward, arrow 2.

MINI Countryman:

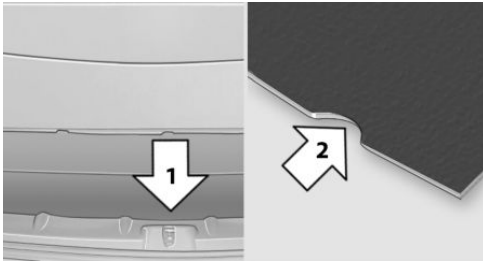

MINI Paceman:

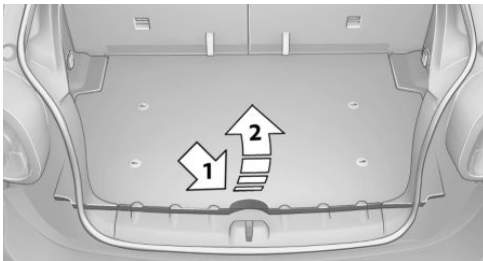

Before closing the tailgate, lower the loading floor back onto the cargo area floor.

Removing

The loading floor can be removed if necessary.

1. Fold up the loading floor.
2. Pull it back slightly and out of the holders.
3. Then remove it upward.

The folded loading floor can be stored in the cargo area.

MINI Countryman: partition net

Before installing

1. Remove the pouch with the partition net from the storage compartment under the loading floor in the cargo area.
2. Take the partition net out of the pouch, unroll it, and unfold it.

After use, fold and roll up the partition net in the same manner and place it in the pouch so that it can be stowed back under the cargo floor panel. Ensure that hooks and tensioning buckles do not rest on the rod elements.

3. Unfold the partition net to the point where the rod elements engage.

Installation behind the front seats

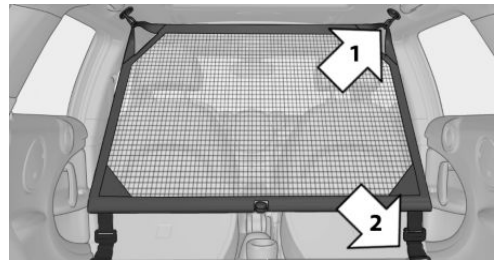

1. Take out the cargo cover if necessary.
2. Fold down the rear seat backrests, refer to Enlarging the cargo area.
3. Insert the retaining pins of the partition net all the way into the front holders in the headliner, arrow 1, and push forward.
4. Attach the hooks, arrow 2, at the bottom of the retaining straps on both sides to the eyelets on the vehicle floor. Firmly attach the partition net.
5. Lash the partition net tightly. To do this, tighten the retaining straps using the tensioning buckles.

Removing

To remove and stow the partition net, proceed in reverse order.

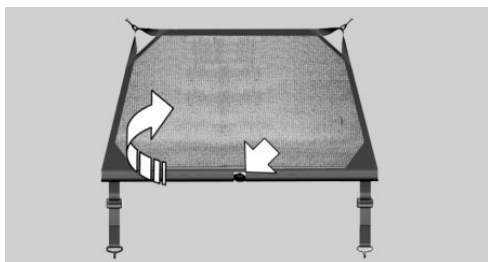

To fold up, press the release button, arrow.

MINI Countryman: multi-function hook

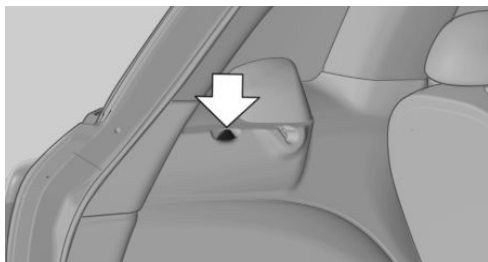

Hooks designed for hanging shopping bags and totes, for example, are located on the left and right sides of the cargo cover support, arrow.

WARNING

Improper use of the multifunction hooks can lead to a danger of objects flying about during braking and evasive maneuvers. There is risk of injuries and risk of property damage. Only hang lightweight objects, e.g. shopping bags, from the multifunction hooks. Only transport heavy luggage in the cargo area if it has been appropriately secured. ◀

STORAGE COMPARTMENTS

VEHICLE FEATURES AND OPTIONS

This chapter describes all standard, country-specific and optional features offered with the series. It also describes features that are not necessarily available in your car, e. g., due to the selected options or country versions. This also applies to safety-related functions and systems.

When using the features and systems described here, adhere to local regulations.

INFORMATION

WARNING

Loose objects in the car's interior can be thrown into the car's interior while driving, e.g. in the event of an accident or during braking and evasive maneuvers. There is risk of injuries. Secure loose objects in the car's interior. ◀

CAUTION

Anti-slip pads such as anti-slip mats can damage the dashboard. There is risk of property damage. Do not use anti-slip pads. ◀

STORAGE COMPARTMENTS

Interior

- ▷ Glove compartment, refer to page 115.
 - ▷ Center armrest, refer to page 116.
 - ▷ Center rail, refer to page 116.
 - ▷ Compartments in the center console.
 - ▷ Compartments in the doors.
 - ▷ Pockets on the back of the front seat backrests.
- ▷ Cupholders, refer to page 109.
 - ▷ Clothes hooks, refer to page 117.

Cargo area

- ▷ Lashing eyes, refer to page 126.
- ▷ Storage compartment under the flat loading floor, refer to page 113.
- ▷ Multi-function hook on the cargo cover support, refer to page 114.

GLOVE COMPARTMENT

Opening

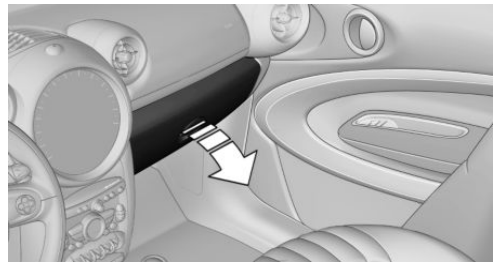

Pull the handle to open the lid.

The light in the glove compartment switches on.

Closing

Fold up the cover.

WARNING

Folded open, the glove compartment protrudes in the car's interior. Objects in the glove compartment can be thrown into the car's interior while driving, e.g. in the event of an accident or during braking and evasive maneuvers. There is risk of injuries. Always close the glove compartment immediately after using it. ◀

Ventilation

Depending on the vehicle's equipment, the glove compartment can be ventilated and, if the cooling function is switched on, cooled.

Opening

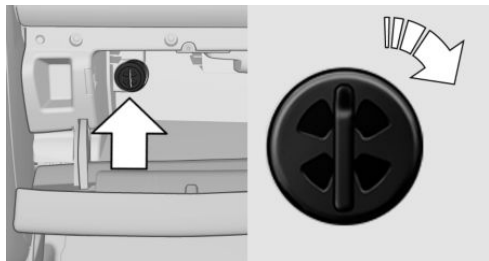

Turn the switch in the direction of the arrow.

Closing

Move the switch to the vertical position by turning it in the opposite direction of the arrow.

Depending on the temperature setting of the air conditioning or automatic climate control, high temperatures may occur in the glove compartment.

USB interface for data transfer

Updating the navigation data, refer to page 132, from the USB medium via the USB interface in the glove compartment.

Observe the following when connecting:

- ▶ Do not use force when plugging the connector into the USB interface.
- ▶ Do not connect devices such as fans or lights to the USB interface.
- ▶ Do not connect USB hard drives.
- ▶ Do not use the USB interface to recharge external devices.

CENTER ARMREST

The center armrest between the front seats contains a storage compartment or a cover for

the snap-in adapter, refer to page 198, depending on the equipment.

Do not position tall accessory parts directly on the center rail of the center armrest; otherwise, they may be damaged when the center armrest is opened or closed.

Center armrest front

Opening

Press the button, arrow, and pull up the lid.

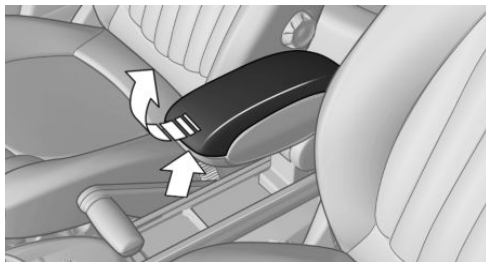

CENTER RAIL

Rail segment

The rail segment can be used to secure various objects that are placed into the rail against slipping, such as a ball point pen or smartphone.

In addition, the connection cable of the smartphone can be secured using the rail segment.

1. Twist the rail segment, arrow 1, to remove it.
2. Insert the connection cable centrally into the recess, arrow 2.

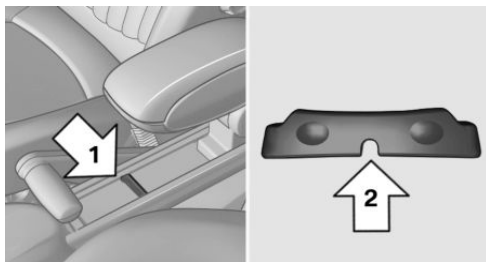

3. Fix the rail segment in the rail.

CLOTHES HOOKS

Clothes hooks are located on the grab handles in the rear.

WARNING

Clothing articles on the clothes hooks can obstruct the view while driving. There is risk of an accident. When suspending clothing articles from the hooks, ensure that they will not obstruct the driver's view. ◀

WARNING

Improper use of the clothes hooks can lead to a danger of objects flying about during braking and evasive maneuvers. There is risk of injuries and risk of property damage. Only hang lightweight objects, e.g. clothing articles, from the clothes hooks. ◀

CONNECTION FOR AN EXTERNAL AUDIO DEVICE

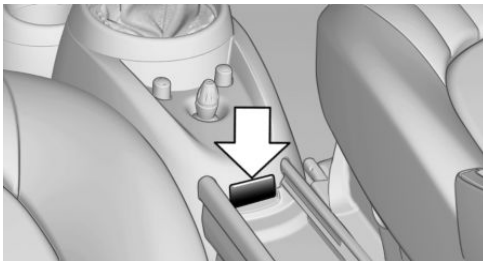

This can be used to connect an external audio device, refer to page 167, such as a CD or MP3 player.



DRIVE ME.

AT A GLANCE

CONTROLS

DRIVING TIPS

NAVIGATION

ENTERTAINMENT

COMMUNICATION

MOBILITY

REFERENCE

THINGS TO REMEMBER WHEN DRIVING

VEHICLE FEATURES AND OPTIONS

This chapter describes all standard, country-specific and optional features offered with the series. It also describes features that are not necessarily available in your car, e. g., due to the selected options or country versions. This also applies to safety-related functions and systems.

When using the features and systems described here, adhere to local regulations.

BREAKING-IN PERIOD

General information

Moving parts need to be broken in to adjust to each other.

The following instructions will help achieve a long vehicle life and good economy.

Engine and differential

Always obey all official speed limits.

Up to 1,200 miles/2,000 km

Drive at various engine and vehicle speeds, but do not exceed:

- ▷ For a gasoline engine, 4,500 rpm and 100 mph/160 km/h.

Avoid full-throttle operation and use of the transmission's kickdown mode for the initial miles.

From 1,200 miles/2,000 km

The engine and vehicle speed can gradually be increased.

Tires

Due to technical factors associated with their manufacture, tires do not achieve their full traction potential until after an initial breaking-in period.

Drive conservatively for the first 200 miles/300 km.

Brake system

Brakes require an initial break-in period of approx. 300 miles/500 km to achieve optimized contact and wear patterns between brake pads and discs. Drive cautiously during this break-in period.

Clutch

The clutch requires an initial break-in period of approx. 300 miles/500 km to function at an optimal level.

During this break-in period, engage the clutch gently.

Following part replacement

The same breaking in procedures should be observed if any of the components mentioned above have to be renewed in the course of the vehicle's operating life.

GENERAL DRIVING NOTES

Ground clearance



CAUTION

If ground clearance is insufficient, there might be contact with the front or rear spoiler e.g. when driving over curbs or entering into underground car parking garages. There is risk of property damage. Ensure that there is sufficient ground clearance available. ◀

Closing the tailgate



WARNING

An open tailgate protrudes from the vehicle and can endanger occupants and other traffic participants or damage the vehicle in the event of an accident, braking or evasive maneuvers. In addition, exhaust fumes may enter the vehicle interior. There is risk of injuries or risk of property damage. Do not drive with the tailgate open. ◀

If, despite this, the vehicle must be driven with the tailgate open:

- ▷ Drive moderately.
- ▷ Close all windows and the glass sunroof.
- ▷ Switch off recirculated air mode and greatly increase the blower speed.

Hot exhaust system



WARNING

During driving operation, high temperatures can occur underneath the body, e.g. caused by the exhaust gas system. If combustible materials, such as leaves or grass, come in contact with hot parts of the exhaust gas system, these materials can ignite. There is risk of injuries or risk of property damage.

Do not remove the heat shields installed and never apply undercoating to them. Make sure that no combustible materials can come in contact with hot vehicle parts in driving operation, idle or during parking. Do not touch the hot exhaust system. ◀

Mobile communication devices in the vehicle



WARNING

The vehicle's performance may be affected by interference from high frequency radio signals. These signals are emitted by a series of transmission systems, such as from air traffic beacons or relay stations for mobile telecommunications.

If you have problems of this nature, we recommend that you consult your dealer's service center or another qualified service center or repair shop. ◀

Hydroplaning

On wet or slushy roads, a wedge of water can form between the tires and road surface.

This phenomenon is referred to as hydroplaning. It is characterized by a partial or complete loss of contact between the tires and the road surface, ultimately undermining your ability to steer and brake the vehicle.

The risk of hydroplaning increases as the tire tread depth decreases. Minimum tread depth, refer to page 224.

Driving through water

Drive through calm water only if it is not deeper than 12 inches/30 cm and at this height, no faster than walking speed, up to 6 mph/10 km/h.

Using the parking brake on inclines

On inclines, do not hold the vehicle stationary with a slipping clutch for extended period; use the parking brake instead. Otherwise, the clutch will be subject to increased wear.

Support from the hill drive-off assistant, refer to page 95.

Braking safely

The vehicle is equipped with ABS as a standard feature.

Applying the brakes fully is the most effective way of braking in situations when this is necessary.

The vehicle maintains steering responsiveness. You can still avoid any obstacles with a minimum of steering effort.

Pulsation of the brake pedal and sounds from the hydraulic circuits indicate that ABS is in its active mode.

Objects in the area around the pedals



WARNING

Objects in the driver's floor area can limit the pedal distance or block a depressed pedal. There is risk of an accident. Stow objects in the vehicle such that they are secured and cannot enter into the driver's floor area. Use floor mats that are suitable for the vehicle and can be safely attached to the floor. Do not use loose floor mats and do not layer several floor mats. Make sure that there is sufficient clearance for the pedals. Ensure that the floor mats are securely fastened again after they were removed, e.g. for cleaning. ◀

Driving in wet conditions

When roads are wet or there is heavy rain, briefly exert gentle pressure on the brake pedal every few miles.

Ensure that this action does not endanger other road users.

The heat generated in this process helps dry the brake discs and pads.

In this way braking efficiency will be available when you need it.

Hills

Drive long or steep downhill gradients in the gear in which the least braking is required. Otherwise, the brake system may overheat, resulting in a reduction in the brake system efficiency.

You can increase the engine's braking effect by shifting down, going all the way to first gear, if necessary.

Downshifting in manual mode of the Steptronic transmission, refer to page 66.



WARNING

Light but consistent brake pressure can lead to high temperatures, brakes wearing out and possibly even brake failure. There is risk of

an accident. Avoid placing excessive load on the brake system. ◀



WARNING

In idle or with the engine switched off, safety-relevant functions are restricted or not available anymore, e.g. braking effect of the engine or braking force and steering support. There is risk of an accident. Do not drive in idle or with the engine switched off. ◀

Brake disc corrosion

Corrosion on the brake discs and contamination on the brake pads are furthered by:

- ▷ Low mileage.
- ▷ Extended periods when the vehicle is not used at all.
- ▷ Infrequent use of the brakes.

Corrosion occurs when the minimum pressure that must be exerted by the pads during brake applications to clean the discs is not reached.

Should corrosion form on the brake discs, the brakes will tend to respond with a pulsating effect that generally cannot be corrected.

When the vehicle is parked

When using the automatic climate control, condensation water develops that exits underneath the vehicle.

Therefore, traces of condensed water under the vehicle are normal.

After the engine is switched off, the coolant pump may continue running for some time in the MINI Cooper S. This causes noises in the engine compartment.

Driving on poor roads

Your MINI with ALL4 all-wheel drive feels comfortable on all streets and roads. It combines an all-wheel drive system with the advantages of a normal passenger car.

**CAUTION**

Objects in unpaved areas, e.g. stones or branches, can damage the vehicle. There is risk of property damage. Do not drive on unpaved terrain. ◀

For your own safety and the safety of passengers and the vehicle, adhere to the following points:

- ▷ Familiarize yourself with the vehicle before driving; never take risks.
- ▷ Adjust speeds according to road conditions. The steeper and rougher the road surface is, the lower the speed should be.
- ▷ When driving on steep uphill and downhill grades: the engine oil and coolant should be filled nearly to the MAX mark.
- ▷ Watch for stones, holes, and other obstacles and drive around these where possible.
- ▷ On bumps and rough roads, avoid contact between the vehicle body and the ground. The maximum ground clearance is 6 inches/15 cm and may vary with the loaded cargo.
- ▷ When driving through water, do not exceed the maximum water height of 12 inches/30 cm and drive at walking speed.
- ▷ After driving through water, press on the brake pedal several times at low speeds to dry the brakes.
- ▷ Depending on the prevailing terrain, activate Dynamic Traction Control DTC briefly, refer to page 94.
- ▷ When the wheels spin, accelerate to enable the driving stability control systems to distribute the drive force to the individual wheels.

After driving on poor roads

Adhere to the following points to ensure vehicle safety:

- ▷ Remove excessive accumulations of dirt and mud from the vehicle body.

- ▷ Clear mud, snow, ice, etc., from the wheels and tires and check for damage.

LOADING

VEHICLE FEATURES AND OPTIONS

This chapter describes all standard, country-specific and optional features offered with the series. It also describes features that are not necessarily available in your car, e. g., due to the selected options or country versions. This also applies to safety-related functions and systems.

When using the features and systems described here, adhere to local regulations.

GENERAL INFORMATION

WARNING

High gross weight can overheat the tires, damage them internally, and cause a sudden drop in tire inflation pressure. There is risk of an accident. Pay attention to the permitted load capacity of the tires and never exceed the permitted gross weight. ◀

CAUTION

Fluids in the cargo area can cause damage. There is risk of property damage. Make sure that no fluids leak in the cargo area. ◀

WARNING

Loose objects in the car's interior can be thrown into the car's interior while driving, e.g. in the event of an accident or during braking and evasive maneuvers. There is risk of injuries. Secure loose objects in the car's interior. ◀

DETERMINING THE LOAD LIMIT

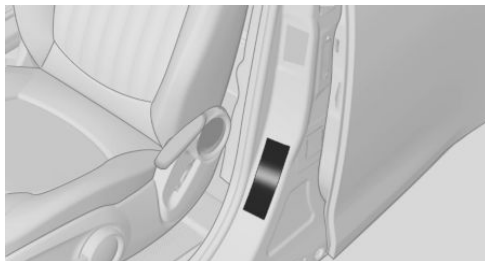

1. Locate the following statement on your vehicle's placard:
 - ▷ The combined weight of occupants and cargo should never exceed XXX kg or YYY lbs. Otherwise, damage to the vehicle and unstable driving situations may result.
2. Determine the combined weight of the driver and passengers that will be riding in your vehicle.
3. Subtract the combined weight of the driver and passengers from XXX kilograms or YYY pounds.
4. The resulting figure equals the available amount of cargo and luggage load capacity.

For example, if the YYY amount equals 1,000 lbs and there will be four 150 lbs passengers in your vehicle, the amount of available cargo and luggage load capacity is 400 lbs: 1,000 lbs minus 600 lbs = 400 lbs.
5. Determine the combined weight of luggage and cargo being loaded on the vehicle. That weight may not safely exceed the

available cargo and luggage load capacity calculated in Step 4.

6. If your vehicle will be towing a trailer, load from your trailer will be transferred to your vehicle. Consult the manual for transporting a trailer to determine how this may reduce the available cargo and luggage load capacity of your vehicle.

LOAD

4-seater:

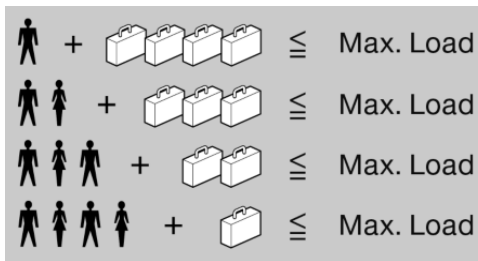

5-seater:

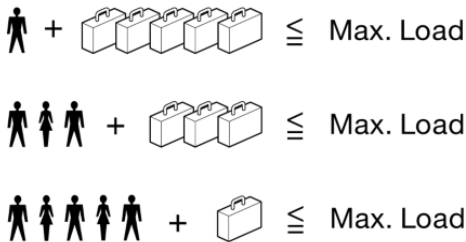

The maximum load is the sum of the weight of the occupants and the cargo.

The greater the weight of the occupants, the less cargo that can be transported.

STOWING CARGO

- ▶ Very heavy cargo: when the rear seat is not occupied, secure each of the outer safety belts in the opposite buckle.

- ▶ Heavy cargo: stow as far forward and as low as possible, ideally directly behind the backrests.
- ▶ Cover sharp edges and corners.
- ▶ Do not stack cargo above the top edge of the backrests.
- ▶ If necessary, fold down the rear backrests to stow cargo.
- ▶ Use the partition net, refer to page 113, to protect passengers. Make sure that objects cannot penetrate the partition net.
- ▶ Place protective material around any sharp-edged or pointed objects that could bump against the rear window while the vehicle is in motion.

MINI Countryman

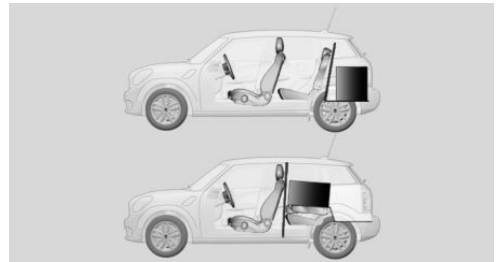

MINI Paceman

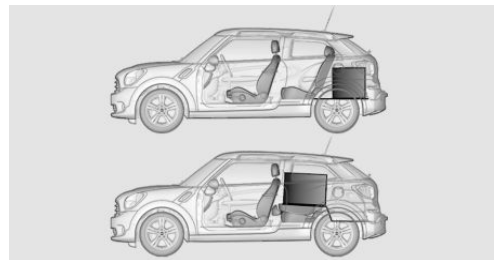

SECURING CARGO

Lashing eyes in the cargo area

MINI Countryman

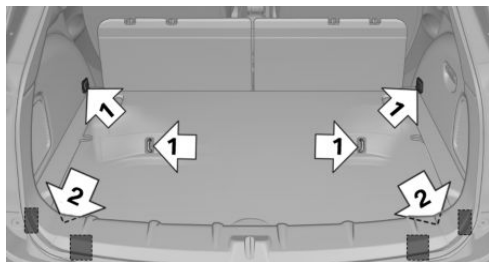

MINI Paceman

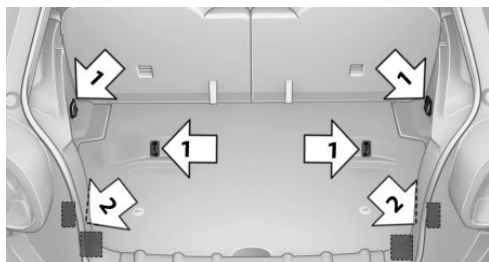

Securing cargo

- ▷ Secure smaller and lighter pieces with tightening belts or straps.
- ▷ Secure larger and heavier pieces with cargo straps.

Adhere to the information included with the cargo straps.

- ▷ Eight mounting eyes are available for fastening the cargo straps.

Two of them are located on the side wall of the cargo area, arrows 1, and two are located on the rear wall of the cargo area, arrows 2.



WARNING

Improperly stowed objects can shift and be thrown into the car's interior, e.g. in the event of an accident or during braking and eva-

sive maneuvers. Vehicle occupants can be hit and injured. There is risk of injuries. Stow and secure objects and cargo properly.

Do not secure cargo using the upper LATCH mounting points, refer to page 56; otherwise, these may become damaged. ◀

ROOF-MOUNTED LUGGAGE RACK

Information

A special rack system is available as an optional accessory.

Securing

Follow the installation instructions of the roof rack.

Ensure that adequate clearance is available for the movement of the glass sunroof.

Loading

Because roof racks raise the vehicle's center of gravity when loaded, they have a major effect on vehicle handling and steering response.

Therefore, note the following when loading and driving:

- ▷ Do not exceed the approved roof/axle loads and the approved gross vehicle weight.
- ▷ Distribute the roof load uniformly.
- ▷ The roof load should not extend past the loading area.
- ▷ Always load the heaviest pieces on the bottom.
- ▷ Secure the roof luggage firmly, e.g., tie with ratchet straps.
- ▷ Do not let objects project into the opening path of the tailgate.
- ▷ Drive smoothly. Avoid sudden acceleration and braking maneuvers. Take corners gently.

REAR LUGGAGE RACK

Information

A special rear rack is available as an optional accessory. It does not require a trailer hitch.

Follow the installation instructions for the rear rack.

Anchorage points

MINI Countryman:



MINI Paceman:

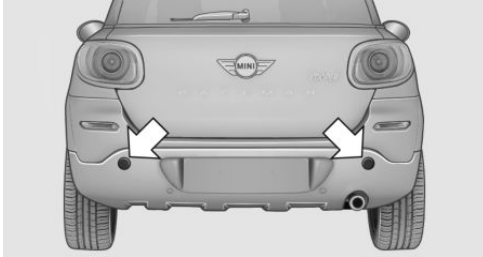

The anchorage points are under the covers in the bumper.

Push out the covers on the corresponding cut-outs.

Loading

When loading the vehicle, ensure that the approved gross vehicle weight and the axle loads are not exceeded. Adhere to the weight specifications in the technical data.

SAVING FUEL

VEHICLE FEATURES AND OPTIONS

This chapter describes all standard, country-specific and optional features offered with the series. It also describes features that are not necessarily available in your car, e. g., due to the selected options or country versions. This also applies to safety-related functions and systems.

When using the features and systems described here, adhere to local regulations.

GENERAL INFORMATION

Your vehicle contains advanced technology for the reduction of fuel consumption and emissions.

Fuel consumption depends on a number of different factors. The implementation of certain measures, driving style and regular maintenance can have an influence on fuel consumption and on the environmental impact.

REMOVE UNNECESSARY CARGO

Additional weight increases fuel consumption.

REMOVE ATTACHED PARTS FOLLOWING USE

Remove unneeded auxiliary mirrors, roof or rear luggage racks after use.

Attached parts on the vehicle impair the aerodynamics and increase the fuel consumption.

CLOSE BOTH WINDOWS

Open windows causes higher air resistance and thus increases fuel consumption.

CHECK THE TIRE INFLATION PRESSURE REGULARLY

Check and, if necessary, correct the tire inflation pressure, refer to page 218, at least twice a month and before starting on a long trip.

Low tire inflation pressure increases rolling resistance and thus raises fuel consumption and tire wear.

DRIVE AWAY WITHOUT DELAY

Do not wait for the engine to warm-up while the vehicle remains stationary. Start driving right away, but at moderate engine speeds. This is the fastest way for the cold engine to reach its operating temperature.

LOOK WELL AHEAD WHEN DRIVING

Avoid unnecessary acceleration and braking. To achieve this, maintain a suitable distance to the vehicle driving ahead of you.

Driving smoothly and looking ahead reduces fuel consumption.

AVOID HIGH ENGINE SPEEDS

Use 1st gear to get the vehicle in motion. Beginning with 2nd gear, accelerate rapidly. When

accelerating, shift up before reaching high engine speeds.

When you reach the desired speed, shift into the highest applicable gear and drive with the engine speed as low as possible and at a constant speed.

As a rule: driving at low engine speeds lowers fuel consumption and reduces wear.

USE COASTING CONDITIONS

When approaching a red light, take your foot off the accelerator and coast to a halt in the highest applicable gear.

On a downhill slope, take your foot off the accelerator and coast in a suitable gear.

The flow of fuel is interrupted while coasting.

SWITCH OFF THE ENGINE DURING LONGER STOPS

Switch off the engine during longer stops, e.g., at traffic lights, railroad crossings or in traffic congestion.

Fuel savings are already achieved after the engine is turned off for as little as 4 seconds.

SWITCH OFF ANY FUNCTIONS THAT ARE NOT CURRENTLY NEEDED

Functions such as seat heating and the rear window defroster require a lot of energy and consume additional fuel, especially in city and stop-and-go traffic.

Therefore, switch off these functions if they are not actually needed.

HAVE MAINTENANCE CARRIED OUT

Have vehicles maintained regularly to achieve optimal vehicle efficiency and service life. MINI recommends that maintenance work be performed by a MINI dealer's service center.

For information on the MINI Maintenance System, refer to page [236](#).



FOLLOW ME.

AT A GLANCE

CONTROLS

DRIVING TIPS

NAVIGATION

ENTERTAINMENT

COMMUNICATION

MOBILITY

REFERENCE

NAVIGATION SYSTEM

VEHICLE FEATURES AND OPTIONS

This chapter describes all standard, country-specific and optional features offered with the series. It also describes features that are not necessarily available in your car, e. g., due to the selected options or country versions. This also applies to safety-related functions and systems.

When using the features and systems described here, adhere to local regulations.

GENERAL INFORMATION

The navigation system can determine the precise position of the vehicle, with the aid of satellites and vehicle sensors, and can reliably guide you to every entered destination.



WARNING

Operating the integrated information system and communication devices while driving can distract from traffic. It is possible to lose control of the vehicle. There is risk of an accident. Only use the systems or devices when the traffic situation allows. If necessary stop and use the systems and devices while the vehicle is stationary. ◀

Opening the navigation system

1. "Navigation"

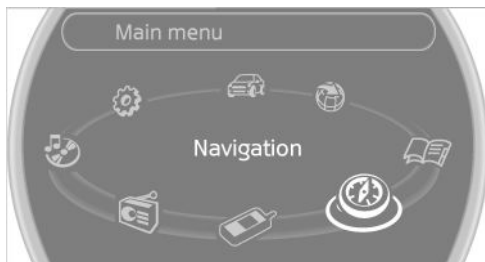

During destination guidance, the arrow or map view appears on the Control Display.

NAVIGATION DATA

Information on navigation data

1. "Navigation"
2. Open "Options".
3. "Navigation system version"

Information is displayed on the data version.

Updating the navigation data

General information

Navigation data are stored in the vehicle and can be updated.

Current navigation data and the authorization code can be obtained from a dealer's service center or another qualified service center or repair shop.

- ▷ Depending on the data volume, a data update may take several hours.
- ▷ Update during the trip to preserve battery.
- ▷ The status of the update can be viewed.
- ▷ The data are stored in the vehicle.

- ▷ After the updating process is complete, the system restarts.
- ▷ Remove the medium with the navigation data after the update.

Performing the update

1. Depending on the equipment: insert the USB device with the navigation data into the USB interface in the glove compartment or in the USB audio interface.
2. Follow the instructions on the Control Display.
3. Enter the authorization code of the USB device with the navigation data.
4. Drive off.

The update starts after the authorization code is entered.

When the update is completed, the system restarts.

DESTINATION ENTRY

VEHICLE FEATURES AND OPTIONS

This chapter describes all standard, country-specific and optional features offered with the series. It also describes features that are not necessarily available in your car, e. g., due to the selected options or country versions. This also applies to safety-related functions and systems.

When using the features and systems described here, adhere to local regulations.

OVERVIEW

In entering your destination, it is possible to select from the following options:

- ▷ Enter the destination manually, see below.
- ▷ Select the destination from the address book, refer to page 136.
- ▷ Last destinations, refer to page 137.
- ▷ Special destinations, refer to page 138.
- ▷ Destination entry via map, refer to page 139.
- ▷ Using the home address as the destination, refer to page 137.
- ▷ Destination entry by voice, refer to page 140.

MANUAL DESTINATION ENTRY

General information

The system supports you in entering street names and house numbers by automatically completing the entry and providing entry comparisons, refer to page 23.

Stored town/city and street names can be called up quickly.

- ▷ If the existing entries should not be changed, the entries for the state/province and town/city can be skipped.
- ▷ Destination guidance is started to the town/city center if no street is entered.

Entering a state/province

1. "Navigation"
2. "Enter address"

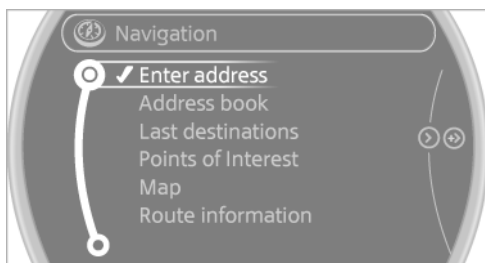

3. Select "State/Province" or the displayed state/province.

Entering a town/city

1. Select "Town/City/Postal Code" or the displayed town/city.

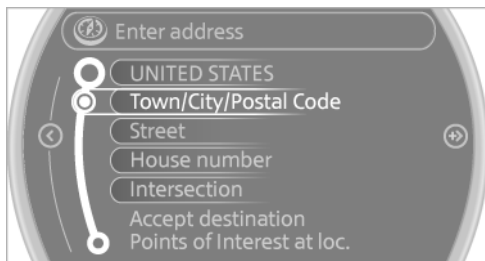

2. Select letters, if necessary.

The list is narrowed down further with each entry.

3. Move the MINI joystick to the right.
4. Select the name of the town/city from the list.

If there are several towns/cities with the same name:

1. Change to the list of town/city names.
2. Highlight the town/city.
3. Select the town/city.

Entering the postal code

1. Select "Town/City/Postal Code" or the displayed town/city.
2. $\text{+}@$ Select the symbol.
3. Select the digits individually.
4. Change to the list of postal codes and towns/cities.
5. Highlight the entry.
6. Selecting an entry.
The associated destination town/city is displayed.

Entering a street and intersection

1. Select "Street" or the displayed street.
2. Enter a street and intersection in the same way as you would enter a town/city.

If there are several streets with the same name:

1. Change to the list of street names.
2. Highlight the street.
3. Select the street.

Alternative: enter the street address and house number

1. Select "Street" or the displayed street.
2. Enter the street as you would the town/city.
3. "House number"
4. Select the numbers.
5. Change to the list of house numbers.
6. Select a house number or range of house numbers.

Street does not exist in the destination city/town

The desired street does not exist in the specified city/town because it belongs to another part of the city/town.

1. "Navigation"
2. "Enter address"
3. Select "Street" or the displayed street.
4. Change to the list of street names.
5. Select "In" with the state/province currently displayed.

All streets of the selected state/province are offered. The associated town/city is displayed after the street name.

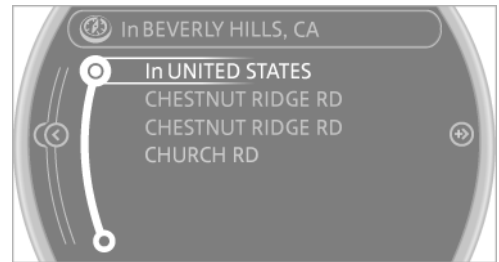

6. Select the letters.
7. Change to the list of street names.
8. Highlight the street.
9. Select the street.

Starting destination guidance after entering the destination

1. "Accept destination"
2. "Start guidance" or "Add as another destination"

Add, refer to page 142, a destination as a further destination.

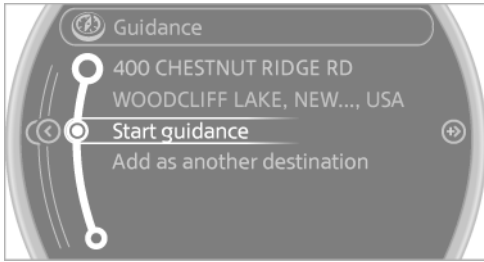

Storing the destination in the address book

After entering the destination, store the destination in the address book.

1. "Navigation"
2. "Map"
3. "Guidance"
4. Open "Options".
5. "Store as new contact" or "Add to existing contact"

ADDRESS BOOK

Create contacts, refer to page 185.

Selecting a destination from the address book

1. "Navigation"
2. "Address book"

Contacts with addresses are displayed if these addresses have been checked as destinations in the contacts.

If the contacts with addresses from the mobile phone are not displayed, they first need to be checked as destinations, refer to page 187.

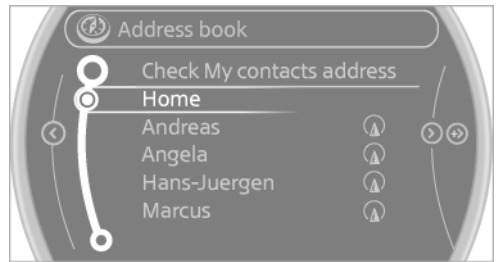

6. Select an existing contact, if available.
7. "Business address" or "Home address"
8. Enter "Last name" and, if necessary, "First name".
9. "Store in vehicle"

Storing the position

The current position can be stored in the address book.

1. "Navigation"
2. Open "Options".

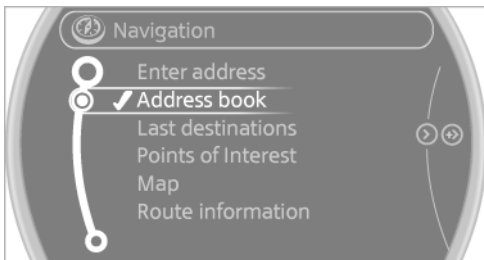

3. Select a contact in the list or, if desired, with "A-Z search".
4. "Business address" or "Home address"

3. "Store position as contact" or "Add position to contact"

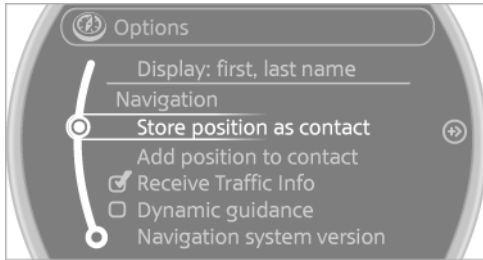

4. Depending on the selection, choose an existing contact from the list. Select the type of address and enter the first and last name.

5. "Store in vehicle"

Editing or deleting an address

1. "Navigation"
2. "Address book"
3. Highlight the entry.
4. Open "Options".
5. "Edit in Contacts" or "Delete entry"

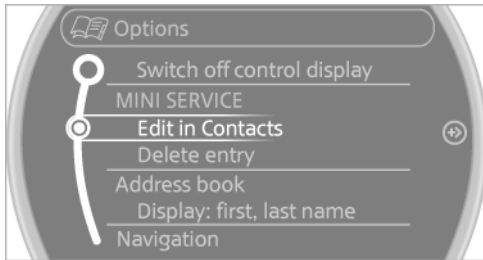

Using the home address as the destination

The home address must be stored. Specify the home address, refer to page 186.

1. "Navigation"
2. "Address book"

3. "Home"

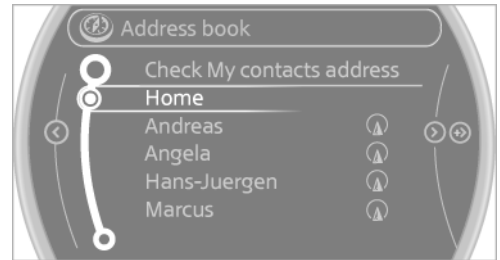

4. "Start guidance"

LAST DESTINATIONS

Overview

The destinations previously entered are stored automatically. These destinations can be called up and used as a destination for destination guidance.

Calling up the last destination

1. "Navigation"
2. "Last destinations"

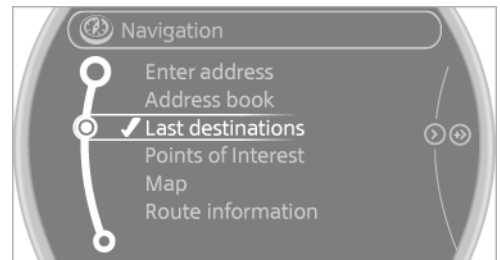

Starting destination guidance

1. "Navigation"
2. "Last destinations"
3. Select the destination.
4. "Start guidance"

Editing the destination

Destinations can be edited, for example to change the house number of an existing entry.

1. "Navigation"
2. "Last destinations"
3. Highlight the destination.
4. Open "Options".
5. "Edit destination"

Deleting the last destinations

1. "Navigation"
2. "Last destinations"
3. Highlight the destination.
4. Open "Options".
5. "Delete entry" or "Delete all last destinations"

SPECIAL DESTINATIONS

General information

Even with the latest navigation data, information on individual Points of Interest may have changed; for example, gas stations might not be in operation.

Opening the search for Points of Interest

Selection of Points of Interest, such as hotels or tourist attractions.

1. "Navigation"
2. "Points of Interest"
3. Select the search function.

A-Z search

1. "A-Z search"
2. "Town/City"
3. Select or enter the town/city.
4. "Category"

5. Select the category.

6. "Category details"

For some Points of Interest, it may be possible to select multiple category details.

Move the MINI joystick to the left to leave the category details.

7. "Keyword"

8. Enter the keyword.

A list of the Points of Interest is displayed.

9. Select a special destination.

Details are displayed.

If multiple details are stored, you can leaf through the pages.

If a phone number is available, a connection can be established if necessary.

10.  Select the symbol.

11. "Start guidance" or "Add as another destination"

Add a destination as a further destination, refer to page [142](#).

Category search

1. "Category search"
2. "Search destination"
3. Select or enter the town/city.
4. "Category"
5. Select the category.
6. "Category details"

For some Points of Interest, it may be possible to select multiple category details.

Move the MINI joystick to the left to leave the category details.

7. "Start search"

A list of the Points of Interest is displayed.

8. Select a special destination.

Details are displayed.

If multiple details are stored, you can leaf through the pages.

If a phone number is available, a connection can be established if necessary.

9.  Select the symbol.
10. "Start guidance" or "Add as another destination"

Add a destination as a further destination, refer to page 142.

Position of Points of Interest

When entering the search location, various options can be selected.

- ▷ "At current location"
- ▷ "At destination"
- ▷ "At different location"
- ▷ If destination guidance is active: "Along route"

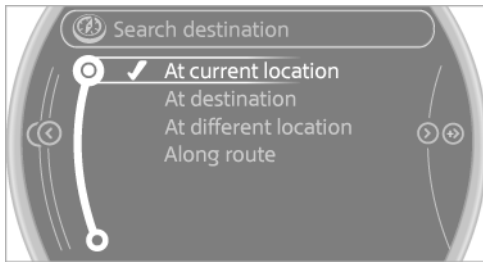

Starting the search for Points of Interest

1. "Start search"
2. A list of the Points of Interest is displayed.
 - ▷ "At current location"

The Points of Interest are listed according to their distance and are displayed with a directional arrow pointing to the destination.
 - ▷ "At destination", "At different location", "Along route"

Special destinations are listed according to their distance from the location where the search is being performed.

- ▷ Destinations of the selected category are displayed in the map view as sym-

bols. The display depends on the map scale and the category.

3. Highlight the special destination.
4. Select a special destination.
5.  Select the symbol.
6. "Start guidance" or "Add as another destination"

The direct distance to destination is displayed.

Displaying Points of Interest in the map

To display symbols of the Points of Interest in the map view:

1. "Navigation"
2. "Map"
3. Open "Options".
4. "Display Points of Interest"

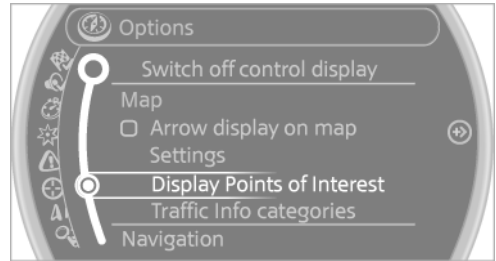

5. Select the setting.

DESTINATION ENTRY BY MAP

General information

If only the location of the destination town/city or street is known, the destination can be entered using the map.

Selecting the destination

1. "Navigation"
2. "Map"

The current position of the vehicle is displayed on the map.

3.  "Interactive map"

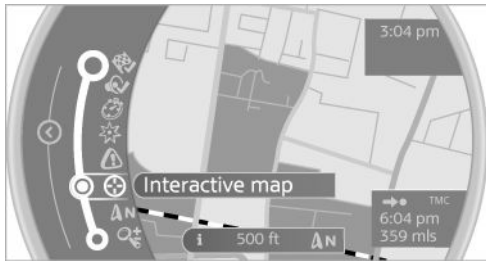

4. Select the destination with crosshairs.
 - ▷ To change the scale: turn the MINI joystick.
 - ▷ To shift the map: move the MINI joystick in the required direction.
 - ▷ To shift the map diagonally: move the MINI joystick in the required direction and turn the MINI joystick.
5. Press the MINI joystick to display additional menu items.
 - ▷  Select the symbol: "Start guidance" or "Add as another destination".
 - ▷ "Find points of interest": the search for Points of Interest is started.

Specifying the street

If the system does not recognize the street, one of the following pieces of information is displayed:

- ▷ A street name in the vicinity.
- ▷ The coordinates of the destination.

Additional functions

On the interactive map, the scale can be adjusted and the map section can be shifted.

Pressing the MINI joysticks makes additional functions available:

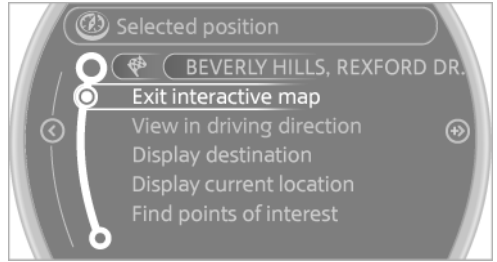

- ▷  Select the symbol. "Start guidance" or "Add as another destination"
- ▷ "Exit interactive map": return to the map view.
- ▷ Map view
- ▷ "Display destination": the map section around the destination is displayed.
- ▷ "Display current location": the map section around your current location is displayed.
- ▷ "Find points of interest": the search for Points of Interest is started.

DESTINATION ENTRY BY VOICE

General information

- ▷ Instructions for voice activation system, refer to page 24.
- ▷ When making a destination entry by voice, you can change between voice activation and the onboard monitor.
- ▷ To have the available spoken instructions read out loud: >Voice commands<.

Saying the entries

- ▷ Countries, towns and cities, streets, and intersections can be said as whole words or spelled in the language of the system, refer to page 73.

Example: to enter a town/city in a US states as a whole word, the language of the system must be English.

- ▷ Spell the entry if the spoken language and the language of the system differ.
- ▷ Say the letters smoothly, and avoid exaggerating the pronunciation and inserting lengthy pauses between the letters.
- ▷ The methods of entry depend on the navigation data in use and the country and language settings.

Entering a town/city separately

The town/city can be said as a complete word.

1.  Press the button on the steering wheel.
2. ›City‹ or ›Spell city‹
3. Wait for the system to prompt you for the town/city.
4. Say the name of the town/city, or name at least the first three letters.
5. Select a location:
 - ▷ Select a recommended town/city: ›Yes‹.
 - ▷ Select a different town/city: ›New entry‹.
 - ▷ Select an entry: ›Entry ...‹, for instance, entry 2.
 - ▷ Spell an entry: ›Spell city‹.
6. Continue making the entry as prompted by the system.

If there are several towns/cities with the same name:

Towns/cities of the same name are grouped in a list and displayed as one location followed by an ellipsis.

1. Select an entry: ›Yes‹ or ›Entry ...‹, e. g., Entry 2.
2. Select the desired town/city.

The town/city can also be selected from the list on the onboard monitor:

Turn the MINI joystick until the destination town/city is selected and press the MINI joystick.

Entering a street or intersection separately

Enter a street and intersection in the same way as you would enter a town/city.

Entering a house number separately

Depending on the data in the navigation system, house numbers up to number 2,000 can be entered.

1. ›House number‹
2. Say the house number.
3. ›Yes‹ to confirm the house number.
4. ›Accept destination‹

Starting destination guidance

›Start guidance‹

Adding further intermediate destinations

›Add as another destination‹

Further intermediate destinations can be added.

Storing a destination

The destination is automatically added to the list of last destinations.

PLANNING A TRIP WITH INTERMEDIATE DESTINATIONS

New trip

Various intermediate destinations can be entered for a trip. The trip destination needs to be entered first, destination entry, refer to page 134.

Entering intermediate destinations

A maximum of 30 intermediate destinations can be entered for a trip.

1. "Navigation"
2. Select the type of destination entry and enter the intermediate destination.

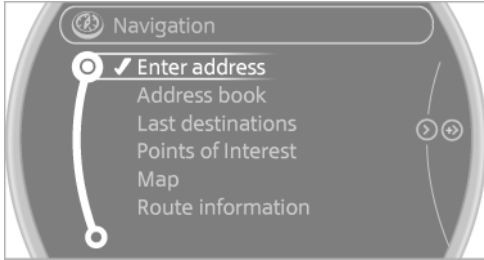

3. "Add as another destination"

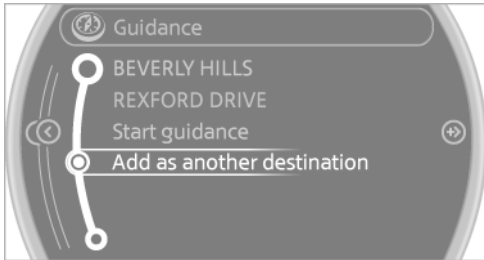

4. Select the position where the intermediate destination is to be inserted.

Starting the trip

After all intermediate destinations have been entered:

"Start guidance"

DESTINATION GUIDANCE

VEHICLE FEATURES AND OPTIONS

This chapter describes all standard, country-specific and optional features offered with the series. It also describes features that are not necessarily available in your car, e. g., due to the selected options or country versions. This also applies to safety-related functions and systems.

When using the features and systems described here, adhere to local regulations.

STARTING DESTINATION GUIDANCE

1. "Navigation"
2. Make a destination entry, refer to page 134.
3. "Accept destination"
4. "Start guidance"

The route is shown on the Control Display.

The distance to the destination/intermediate destination and the estimated time of arrival are displayed in the map view.

The arrow view may appear on the Control Display.

TERMINATING DESTINATION GUIDANCE

1. "Navigation"
2. "Map"
3.  Select the symbol.
4. "Stop guidance"

CONTINUING DESTINATION GUIDANCE

If the destination was not reached during the last trip, destination guidance can be resumed.





"Resume guidance"

ROUTE CRITERIA

General information

- ▷ The route calculated can be influenced by selecting certain criteria.
- ▷ The route criteria can be changed when the destination is entered and during destination guidance.
- ▷ Road types are part of the navigation data and are taken into consideration when planning a route, e.g., avoid highways.
- ▷ The recommended route may differ from the route you would take based on personal experience.
- ▷ The settings are stored for the remote control currently in use.
- ▷ Destination guidance with traffic bulletins, refer to page 149.

Changing the route criteria

1. "Navigation"
2. "Map"
3.    "Route preference"
4. Select the criterion:
 - ▷  "Fast route": time-optimized route, being a combination of the shortest possible route and the fastest roads.
 - ▷  "Efficient route": optimized combination of the fastest and shortest route.

- ▷  "Short route": short distance, irrespective of how fast or slow progress will be.
- ▷ "Alternative routes": if available, alternative routes are suggested during active destination guidance.

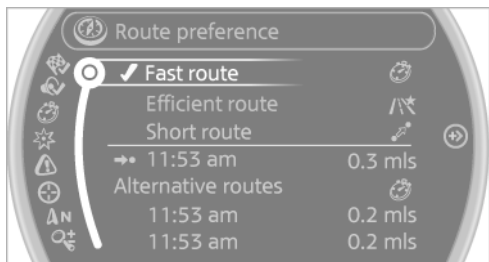

5. Select additional criteria for the route, if necessary. Where possible, the selected criteria are avoided on the route.
 - ▷ "Avoid highways": highways are avoided wherever possible.
 - ▷ "Avoid toll roads": toll roads are avoided wherever possible.
 - ▷ "Avoid ferries": ferries are avoided where possible.

ROUTE

Different views of the route are available during destination guidance:

- ▷ Arrow view.
- ▷ List of route sections.
- ▷ Map view, refer to page 146.

Arrow view

The following information is displayed during destination guidance:

- ▷ Large arrow: indicates the current direction of travel.
- ▷ Street name of the currently traveled street.
- ▷ Small arrow: indicates the next change in direction.

- ▷ Intersection view.
- ▷ Lane information.
- ▷ Traffic bulletins.
- ▷ Distance to the next change in direction.
- ▷ Street name at the next change in direction.

Lane information

On multilane roads, the recommended lanes are marked in the arrow view by a triangle.

- ▷ Solid triangle: best lane.
- ▷ Empty triangle: possible lane. However, another lane change may be needed shortly.

Displaying list of route sections

When destination guidance is activated, a list of route sections can be displayed. The driving distance and traffic bulletins are displayed for each route section.

1. "Navigation"
2. "Route information"

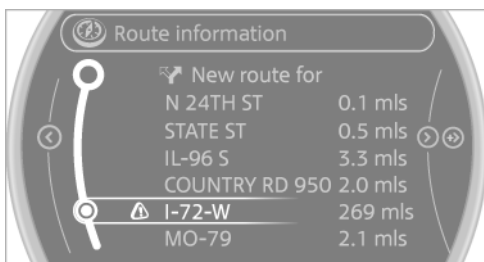

3. Highlight route section.

BYPASSING A SECTION OF THE ROUTE

Calculate a new route for a route section.

1. "Navigation"
2. "Route information"

3. "New route for"

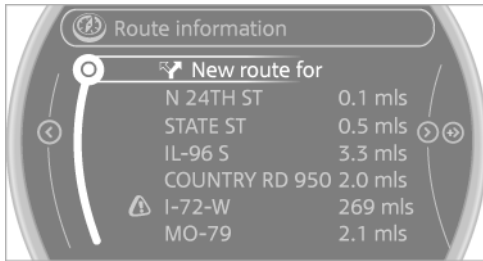

4. Turn the MINI joystick. Enter the number of kilometers within which you would like to return to the original route.
5. Press the MINI joystick.

Resuming the original route

If the route section should no longer be bypassed:

1. "Navigation"
2. "Route information"
3. "New route for:"
4. "Remove blocking"

GAS STATION RECOMMENDATION

The remaining range is calculated, and if needed gas stations along the route are displayed.

Even with the latest navigation data, information on individual Points of Interest may have changed; for example, gas stations might not be in operation.

1. "Navigation"
2. "Route information"
3. "Recommended refuel"
A list of the gas stations is displayed.
4. Highlight a gas station.
5. Select the gas station.

6. Select the symbol.
7. "Start guidance": destination guidance to the selected gas station is started.
"Add as another destination": the gas station is added to the route.

DESTINATION GUIDANCE THROUGH VOICE INSTRUCTIONS

Switching spoken instructions on/off

The spoken instructions can be switched on or off during destination guidance.

Settings are stored for the remote control currently in use.

1. "Navigation"
2. "Map"
3. Select the symbol.

Symbol	Function
	The spoken instructions are switched on.
	Spoken instructions are switched off.

Repeating a spoken instruction

1. "Navigation"
2. "Map"
3. Highlight the symbol.
4. Press the MINI joystick twice.

Volume of spoken instructions

Turn the volume button during the spoken instructions until the desired volume is set.



This volume is independent of the volume of the audio sources.

Settings are stored for the remote control currently in use.

MAP VIEW

Selecting the map view

1. "Navigation"
2. "Map"

Overview

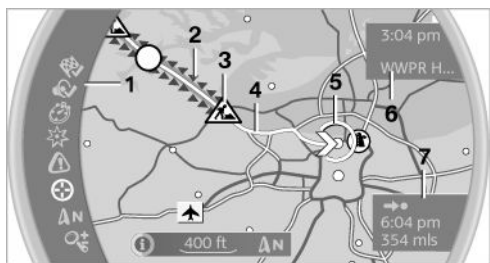

- 1 Function bar
- 2 Route section with traffic obstruction
- 3 Traffic sign for traffic obstruction
- 4 Planned route
- 5 Current location
- 6 Upper status field
- 7 Lower status field

Lines in the map

Streets and routes are displayed in different colors and styles depending on their classifica-

tion. Dashed lines represent railways and ferry connections. Country borders are indicated by thin lines.

Traffic obstructions

Small triangles along the planned route indicate route sections with traffic obstructions, depending on the map scale. The direction of the triangles indicates the direction of the obstruction.

The traffic signs indicate the significance of the obstruction.

- ▷ Red traffic sign: the obstruction affects the planned route or direction.
- ▷ Gray traffic sign: the obstruction does not affect the planned route or direction.

Traffic bulletins, refer to page 147.

Planned route

After destination guidance is started, the planned route is displayed on the map.

Status fields







To show/hide: press the MINI joystick.

- ▷ Upper status field: time, telephone, and entertainment details.
- ▷ Lower status field: symbol for active destination guidance, status of traffic bulletins, time of arrival, and distance to destination.

Function bar

The following functions are available in the function bar:

Symbol	Function
	Start/end destination guidance.
	Switch spoken instructions on/off.
	Change the route criteria.
	Search for a special destination.

Symbol	Function
	Display traffic bulletins.
	Open the interactive map.
  	Adjust the map views.
	Adjust the arrow view.
	Change the scale.

Changing the map section

"Interactive map"

- ▷ To shift the map: move the MINI joystick in the required direction.
- ▷ To shift the map diagonally: move the MINI joystick in the required direction and turn the MINI joystick.

Changing the scale

1.  Select the symbol.
2. To change the scale: turn the MINI joystick.

Automatically scaled map scale

In the map view facing north, turn the MINI joystick in any direction until the AUTO is displayed for the scale. The entire route between the current location and the destination is displayed on the map.

Settings for the map view

The settings are stored for the remote control currently in use.

1. "Navigation"
2. "Map"
3. Open "Options".
4. "Settings"
5. To set the map view:
 - ▷ "Day/night mode"

Select and create the necessary settings depending on the light conditions.

"Traffic conditions/gray map" active: the setting is disregarded.

▷ "Traffic conditions/gray map"

The map is optimized for displaying traffic bulletins.

Symbols for the Points of Interest are no longer displayed.

Arrow view

When destination guidance is activated, the arrow view can additionally be displayed in the map view on the right side of the display.

1. "Navigation"
2. Open "Options".
3. "Arrow display on map"

The arrow view is shown on the map.



TRAFFIC BULLETINS

Overview

- ▷ Display the traffic bulletins from radio stations that broadcast the TI Traffic Information of a traffic information service. Information on traffic obstructions and hazards is updated continuously.
- ▷ The traffic bulletins are indicated on the map by symbols.
 -  The symbol in the function bar of the map view turns red if there are traffic bulletins that affect the calculated route.

Real Time Traffic Information End-User Provisions

Certain MINI models equipped with navigation have the capability to display real-time traffic information. If your system has this capability the following additional terms and conditions apply:

An End-User shall no longer have the right to use the Traffic Data in the event that the End-User is in material breach of the terms and conditions contained herein.

A. Total Traffic Network, a division of Clear Channel Broadcasting, Inc. ("Total Traffic Network") holds the rights to the traffic incident data and RDS-TMC network through which it is delivered. You may not modify, copy, scan or use any other method to reproduce, duplicate, republish, transmit or distribute in any way any portion of traffic incident data. You agree to indemnify, defend and hold harmless MINI of North America, LLC. ("MINI NA") and Total Traffic Network, Inrix, Inc (and their affiliates) against any and all claims, damages, costs or other expenses that arise directly or indirectly out of (a) your unauthorized use of the traffic incident data or the RDS-TMC network, (b) your violation of this directive and/or (c) any unauthorized or unlawful activities by you in connection herewith.

B. Total Traffic Network traffic data is informational only. User assumes all risk of use. Total Traffic Network, MINI NA, and their suppliers make no representations about content, traffic and road conditions, route usability, or speed.

C. The licensed material is provided to license "as is," and "where is". Total Traffic Network, including, but not limited to, any and all third party providers of any of the licensed material, expressly disclaims, to the fullest extent permitted by law, all warranties or representations with respect to the licensed material (including, without limitation, that the licensed material will be error-free, will operate without interruption or that the traffic data will be accurate), express, implied or statutory, including, without



limitation, the implied warranties of merchantability, non-infringement fitness for a particular purpose, or those arising from a course of dealing or usage of trade.

D. Neither Total Traffic Network, Inrix, Inc. or MINI NA will be liable to you for any indirect, special, consequential, exemplary, or incidental damages (including, without limitation, lost revenues, anticipated revenues, or profits relating to the same) arising from any claim relating directly or indirectly to use of the traffic data, and even if Total Traffic Network, Inrix, Inc., or MINI NA are aware of the possibility of such damages. These limitations apply to all claims, including, without limitation, claims in contract and tort (such as negligence, product liability and strict liability). Some states do not allow the exclusion or limitation of incidental or consequential damages, so those particular limitations may not apply to you.

Switching the reception on/off

1. "Navigation"
2. Open "Options".
3. "Receive Traffic Info"

Open the traffic bulletins

1. "Navigation"
2. "Map"
3.  "Traffic Info"
First, traffic bulletins for the calculated route are displayed.
The traffic bulletins are sorted by their distance from the current position of the vehicle.
4. Select a traffic bulletin.
 "More information": display additional information.
5. Scroll to the next or previous traffic bulletin if required.

Traffic bulletins on the map

"Traffic conditions/gray map" active:

The Control Display changes to a black and white display. This enables a better view of the traffic bulletins. The day/night mode is disregarded in this setting. Symbols and Points of Interest are not displayed.

1. "Navigation"
2. "Map"
3. Open "Options".
4. "Settings"
5. "Traffic conditions/gray map"

Symbols in the map view

Depending on the scale of the map and the location of the traffic obstruction along the route, the symbols for the traffic obstructions are displayed.

Additional information in the map view

Depending on the map scale, a traffic obstruction's length, direction, and impact are displayed in the map using triangles or gray bars along the calculated route.

- ▷ Red: traffic congestion.
- ▷ Orange: stop-and-go traffic.
- ▷ Yellow: heavy traffic.
- ▷ Green: clear roads.
- ▷ Gray: general traffic bulletins such as road construction.

The displayed information depends on the particular traffic information service.

Filtering traffic bulletins

You can set which traffic bulletins appear on the map.

1. "Navigation"
2. "Map"
3. Open "Options".

4. "Traffic Info categories"
5. Select the desired category.

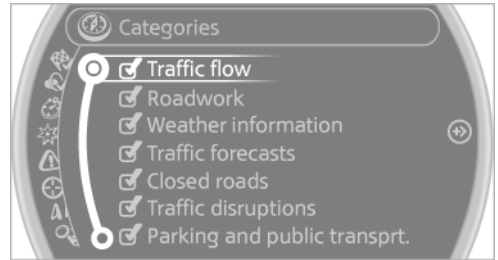

Traffic bulletins of the selected category are displayed on the map.

- ▷ Traffic bulletins that are relevant to the route are always shown.
- ▷ For your own safety, traffic bulletins that notify you of potentially dangerous situations cannot be hidden.

Destination guidance with traffic bulletins

General information

Detour suggestions from the navigation system can be manually accepted in the semi-dynamic destination guidance. In the dynamic destination guidance, they are automatically accepted in the route guidance.

Semi-dynamic destination guidance

When traffic bulletin reception is switched on, semi-dynamic destination guidance is active.



The destination guidance system takes the available traffic information into account. A message is displayed depending on the route, the traffic bulletins, and the possible detour routes. When there is a traffic obstruction, if possible, a detour is offered. In addition, distance and time differences between the original route and the detour are displayed.

Accepting the detour

- 📍 "Detour"

In the event of special hazards, e. g., objects on the road, a message is displayed without a detour suggestion.

Detours can also be accepted if the traffic messages are called up in the list.

1. "Navigation"
2. "Map"
3.  "Traffic Info"
4. "Detour information"
5.  "Detour"

Dynamic destination guidance

The route is automatically changed in the event of traffic obstructions.

- ▷ The system does not point out traffic obstructions along the original route.
- ▷ Traffic bulletins continue to be displayed on the map.
- ▷ Depending on road type and the kind and extent of the traffic obstruction, the calculated route may lead through the traffic obstruction.
- ▷ Dangerous situations are displayed regardless of the setting.

Activating dynamic destination guidance

1. "Navigation"
2. Open "Options".
3. "Dynamic guidance"

WHAT TO DO IF...

WHAT TO DO IF...

- ▶ The current transmission position cannot be displayed?

The vehicle is located in an unrecognized region, is in a poor reception area, or the system is currently determining the position. Reception is usually best when you have an unobstructed view of the sky.

- ▶ The destination without street information is not used for route guidance?

When city has been input, no downtown can be determined. Input any street in the selected city and start destination guidance.

- ▶ The destination is not used for route guidance?

The destination data is not contained in the navigation data. Select a destination that is as close as possible to the original.

- ▶ Letters for destination input cannot be selected?

The stored data do not contain the data of the destination. Select a destination that is as close as possible to the original.

- ▶ Is the map displayed in shades of gray?

"Traffic conditions/gray map" active:

The Control Display changes to a black and white display. This enables a better view of the traffic bulletins.

- ▶ Spoken instructions are no longer output during route guidance in front of intersections?

The area has not yet been fully recorded, or you have left the recommended route and the system requires a few seconds to calculate a new route suggestion.

- ▶ Does the navigation system fail to react to entries?

If the battery was disconnected, it takes up to 10 minutes for the system to becoming functional again.



ROCK ME.

AT A GLANCE

CONTROLS

DRIVING TIPS

NAVIGATION

ENTERTAINMENT

COMMUNICATION

MOBILITY

REFERENCE

TONE

VEHICLE FEATURES AND OPTIONS

This chapter describes all standard, country-specific and optional features offered with the series. It also describes features that are not necessarily available in your car, e. g., due to the selected options or country versions. This also applies to safety-related functions and systems.

When using the features and systems described here, adhere to local regulations.

GENERAL INFORMATION

The sound settings are stored for the remote control currently in use.

TREBLE, BASS, BALANCE, AND FADER

- ▷ "Treble": treble adjustment.
- ▷ "Bass": depth adjustment.
- ▷ "Balance": left/right volume distribution.
- ▷ "Fader": front/rear volume distribution.

Setting treble, bass, balance, and fader

1. "CD/Multimedia", "Radio" or "Settings"
2. "Tone"



3. Select the desired tone settings.

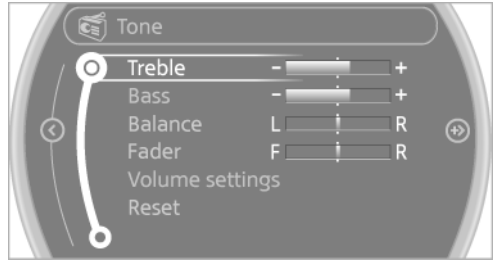

4. To set: turn the MINI joystick.
5. To save: press the MINI joystick.

VOLUME

- ▷ "Speed volume": speed-dependent volume control.
- ▷ "PDC": volume of the PDC signal compared to the entertainment sound output.
- ▷ "Gong": volume of the signal, such as the safety belt reminder, compared to the entertainment sound output.

Bluetooth mobile phone preparation package

- ▷ "Microphone": volume of the microphone during a phone call.
- ▷ "Loudspeak.": volume of the loudspeakers during a phone call.

The following volumes are only stored for the respective paired telephone: "Microphone", "Loudspeak.".

Adjusting the volume

1. "CD/Multimedia", "Radio" or "Settings"
2. "Tone"
3. "Volume settings"

4. Select the desired volume setting.

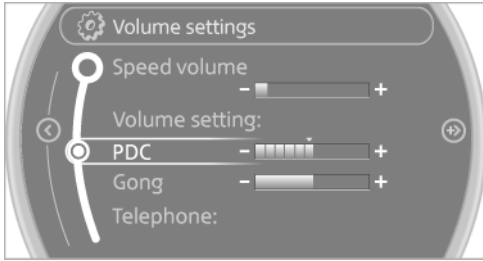

5. To set: turn the MINI joystick.
6. To save: press the MINI joystick.

RESETTING THE TONE SETTINGS

All tone settings can be reset to the default setting.

1. "CD/Multimedia", "Radio" or "Settings"
2. "Tone"
3. "Reset"

RADIO

VEHICLE FEATURES AND OPTIONS

This chapter describes all standard, country-specific and optional features offered with the series. It also describes features that are not necessarily available in your car, e. g., due to the selected options or country versions. This also applies to safety-related functions and systems.

When using the features and systems described here, adhere to local regulations.

CONTROL ELEMENTS



- 1 CD drive
- 2 Changing the waveband
- 3 Changing the audio source
- 4 Volume, on/off
- 5 Change station/track
- 6 Ejecting the CD

SOUND OUTPUT

Switching on/off



When the ignition is switched off: press ON/OFF button on the radio.

Muting

When the ignition is switched on or the engine is running: press the ON/OFF button on the radio.

☒ This symbol at the upper edge of the Control Display indicates that the sound is switched off.

AM/FM STATION

Selecting a station

On the onboard monitor:

1. "Radio"
2. "FM" or "AM"

3. Select the desired station.

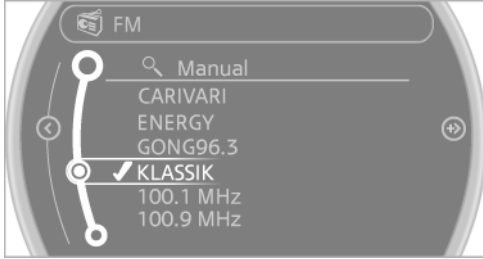

Selecting the waveband using the button on the radio

FM/AM Press the button repeatedly until the desired waveband is displayed.

Changing the station

Turn and press the MINI joystick

or



Press the button

or

Press the buttons on the steering wheel.

All saved stations are stored for the remote control currently in use.

Storing a station

1. "Radio"
2. "FM" or "AM"
3. Highlight the desired station.

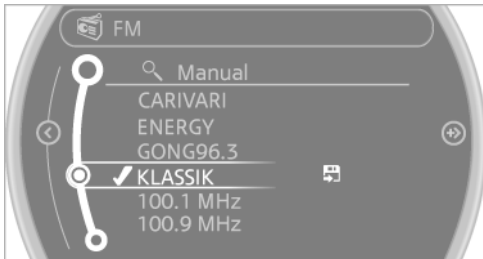

4. Press the MINI joystick.
5. Select the desired memory location.

Press and hold the MINI joystick to store a station that is displayed in the station list but is not being played.

The stations are stored for the remote control currently in use.

Selecting a station manually

Station selection via the frequency.

1. "Radio"
2. "FM" or "AM"
3. "Manual"
4. To select a frequency: turn the MINI joystick.

To save a station: press and hold the MINI joystick.



RDS

RDS broadcasts additional information, such as the station name, in the FM wave band.

Switching the RDS on/off

1. "Radio"
2. "FM"

3. Open "Options".
4. "RDS"

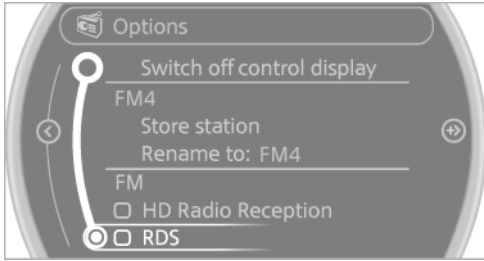

Settings are stored for the remote control currently in use.

HD Radio™ reception

Many stations broadcast both analog and digital signals.

License conditions

HD Radio Technology manufactured under license from iBiquity Digital Corporation. U.S. and Foreign Patents. HD Radio™ and the HD, HD Radio, and Arc logos are proprietary trademarks of iBiquity Digital Corp.

Activating/deactivating digital radio reception

1. "Radio"
2. "FM" or "AM"
3. Open "Options".
4. "HD Radio Reception"

Settings are stored for the remote control currently in use.

 This symbol is displayed in the status line when the audio signal is digital.

When tuning to a station with a digital signal, it may take several seconds for the station to be played back in digital quality.

Note on HD stations whose station name ends in ...HD or HD1:

In areas in which the station is not continuously received in digital mode, the playback switches

between analog and digital reception. In this case, switch off digital radio reception.

Note on HD multicast stations whose station name ends in ...HD2, ...HD3, ...:

In areas in which the station is not continuously received in digital mode, the audible signal may be interrupted for several seconds. This is reception related.

Displaying additional information

Some stations broadcast additional information on the current track, such as the name of the artist.

1. Select the desired station.
2. Open "Options".
3. "Station info"

Selecting a substation

 This symbol indicates that a main station also broadcasts additional substations. The station name of the main station ends in HD1. Station names of the substations end in HD2, HD3, etc.

1. Select the desired station.
2. Press the controller.
3. Select the substation.









When reception is poor, the substation is muted.

SATELLITE RADIO

General information

The channels are offered in predefined packages. The packages must be enabled by telephone.

Navigation bar overview

Symbol	Function
	Change the list view.
	Select the category.
	Direct channel entry
	Timeshift
 	Open the My Favorites category/ open a favorite.
	Manage the favorites.
	Traffic Jump

Managing a subscription

To be able to enable or unsubscribe from the channels, you must have reception. It is usually at its best when you have an unobstructed view of the sky. The channel name is displayed in the status line.

Enabling channels

The Unsubscribed Channels category contains all disabled channels.

1. "Radio"
2. "Satellite radio"
3.  "Category"



4. Select the Unsubscribed Channels category.
5. Select the desired channel.

The phone number and an electronic serial number, ESN, are displayed.

6. Select the phone number to have the channel enabled.

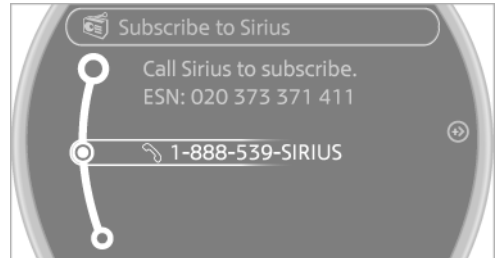

You can unsubscribe from the channels again via this phone number.

Unsubscribing from channels

1. "Radio"
2. "Satellite radio"
3. Open "Options".
4. "Manage subscription"

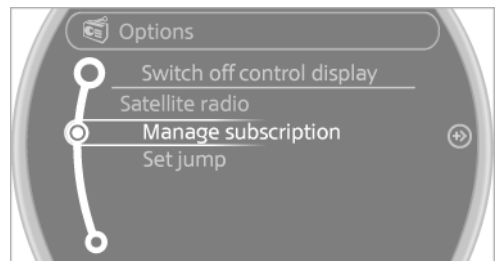

5. The phone number and an electronic serial number, ESN, are displayed.
6. Call Sirius to unsubscribe from the channels.

Selecting channels

You can only listen to enabled channels.

The selected channel is stored for the remote control currently in use.

Via the onboard monitor

1. "Radio"
2. "Satellite radio"
3. Select "All channels" or the desired category.
4. Select the desired channel.



Via the buttons in the area of the CD player



Press the button.

The next channel is selected.

Via direct channel entry

1. "Radio"
2. "Satellite radio"
3. "Set channel"
4. Turn the MINI joystick until the desired channel is reached and press the MINI joystick.

Storing a channel

1. "Radio"
2. "Satellite radio"
3. If necessary, open "All channels" or the desired category.
4. Select the desired channel.
5. Press the MINI joystick again.

6. Press the MINI joystick again to confirm the highlighted channel.



7. Select the desired memory location.

The channels are stored for the remote control currently in use.

Changing the list view

The list view changes every time the first symbol on the navigation bar is pressed.

Information on the channel is displayed.

Symbol	Meaning
	Channel name
	Artist
	Track

Selecting a category

1. "Radio"
2. "Satellite radio"
3. "Category"
4. Select the desired category.

Timeshift

Approx. one hour of the program being broadcast on the channel currently being listened to is stored in a buffer. Prerequisite: the signal must be available.

The stored audio track can be played with a delay following the live broadcast. When the buffer is full, the older tracks are overwritten. The buffer is cleared when a new channel is selected.







Opening the timeshift function

1. "Radio"
2. "Satellite radio"
3.  "Replay - Time shift"



- ▷ The red arrow shows the current playback position.
- ▷ The time difference to the live broadcast is displayed next to the buffer bar.
- ▷ For live transmissions "live".

Timeshift menu

Symbol	Function
	Go to the live broadcast
	Playback/pause
	Next track
	Previous track
	Fast forward
	Reverse
	Automatic timeshift deactivated/activated



Automatic timeshift

When the function is activated, audio playback is stopped automatically in the event of:

- ▷ Incoming and outgoing telephone calls.
- ▷ Activation of the voice activation system.
- ▷ Muting.

The audio playback then continues with a time delay.

Activating

1. "Radio"
2. "Satellite radio"
3.  "Replay - Time shift"
4.  "Automatic time shift"

Deactivating

-  "Automatic time shift"

Storing favorites

Up to 30 favorites can be stored in the favorites list. Available favorites are artist, track, game, league, and team.

Storing the artist, track, or game

It is only possible to store favorites that are currently being broadcast. The channel information must be available.

1. "Radio"
2. "Satellite radio"
3. If necessary, open "All channels" or the desired category.
4. Select the desired channel.
5. Press the MINI joystick again.
6. Select the artist, track, or game.

Storing the league or team

Leagues or teams can be added to the favorites from a selection list.

1. "Radio"
2. "Satellite radio"
3.  "Manage favorites"

4. "Add sports information"



5. Select the league.
6. Select "Add all teams" or the desired team.

Opening the favorites

If an activated favorite is played back, the following message appears for approx. 20 seconds "Favorite alert!".

☆☆ "Favorites"

Select the symbol while the message is shown.

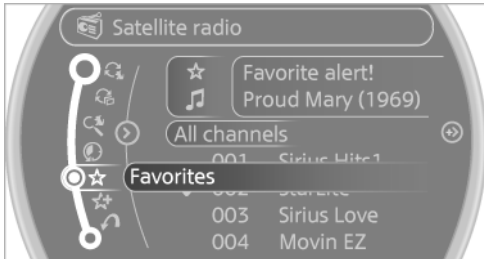

The displayed favorite is played.

If there is no message, the system changes to the My Favorites category. All favorites currently being broadcast can be selected from a list.

Managing the favorites

Activating/deactivating the favorites

Favorites can be activated and deactivated globally and individually.

1. "Satellite radio"
2. ☆+ "Manage favorites"

3. Select "Activate alert" or the desired favorites.

Settings are stored for the remote control currently in use.

Deleting favorites

1. "Satellite radio"
2. ☆+ "Manage favorites"
3. Highlight the desired favorite.
4. Open "Options".
5. "Delete entry"

Traffic Jump

Traffic and weather information for a selected region is broadcast every few minutes.

Selecting a region

1. "Radio"
2. "Satellite radio"
3. Open "Options".
4. "Set jump"
5. Select the desired region.

The region is stored for the remote control currently in use.

Activating/deactivating the jump

1. "Radio"
2. "Satellite radio"
3. ↻ "Jump to:"

Information for the selected region is broadcast as soon as it is available.

A new panel opens.

Canceling the Traffic Jump: "Cancel".

Symbol	Meaning
↻	Information will be broadcast shortly.
↻	Information is currently being broadcast.

Select one of the symbols to deactivate Traffic Jump.

Automatic update

About twice a year, Sirius performs an update of the channel names and positions. The update takes place automatically and may take several minutes.

Information

- ▷ Reception may not be available in some situations, such as under certain environmental or topographic conditions. The satellite radio has no influence on this.
- ▷ The signal may not be available in tunnels or underground garages; next to tall buildings; or near trees, mountains or other powerful sources of radio interference.

STORED STATIONS

General information

It is possible to store up to 40 stations.

Calling up a station

1. "Radio"
2. "Presets"
3. Select the desired station.

Storing a station

The station currently selected is stored.

1. "Radio"
2. "Presets"

3. "Store station"



4. Select the desired memory location.
The list of stored stations is stored for the remote control currently in use.

Deleting a station

1. "Radio"
2. "Presets"
3. Select the desired station.
4. Open "Options".
5. "Delete entry"

CD/MULTIMEDIA

VEHICLE FEATURES AND OPTIONS

This chapter describes all standard, country-specific and optional features offered with the series. It also describes features that are not necessarily available in your car, e. g., due to the selected options or country versions. This also applies to safety-related functions and systems.

When using the features and systems described here, adhere to local regulations.

SOUND OUTPUT

Switching on/off



When the ignition is switched off: press ON/OFF button on the radio.

Muting

When the ignition is switched on or the engine is running: press the ON/OFF button on the radio.

🔇 This symbol at the upper edge of the Control Display indicates that the sound is switched off.

CD PLAYER

Playback

Inserting the CD

Insert the CD with the printed side facing up. Playback begins automatically.

Reading can take a few minutes with compressed audio files.

Starting playback

A CD is contained in the CD player.

1. "CD/Multimedia"
2. "CD"
3. Select the desired track. Press the MINI joystick to start playback.

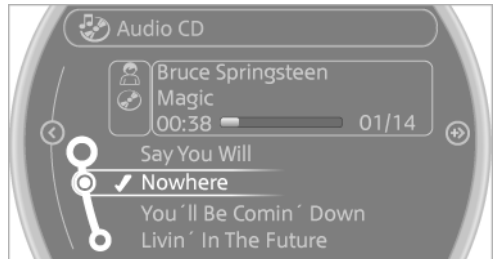

Playable formats

- ▷ CD: CD-ROM, CD-R, CD-RW, CD-DA.
- ▷ Compressed audio files: MP3, WMA, AAC.

Ejecting the CD



Press the button on the CD player.

The CD emerges slightly from the drive.

Audio playback

Selecting the track using the button



Press the button for the appropriate direction as often as necessary until the desired track is played back.

Selecting the track on the onboard monitor

Audio CDs

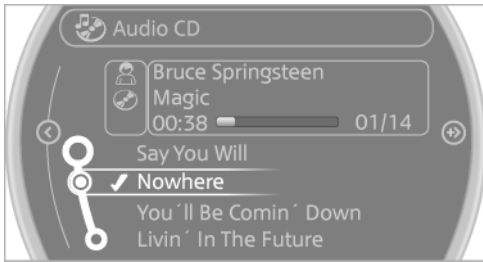

Select the desired track to begin playback.

CDs with compressed audio files

Depending on the data, some letters and numbers of the CD may not be displayed correctly.

1. Select the directory if necessary.

To change to a higher level directory: move the MINI joystick to the left.

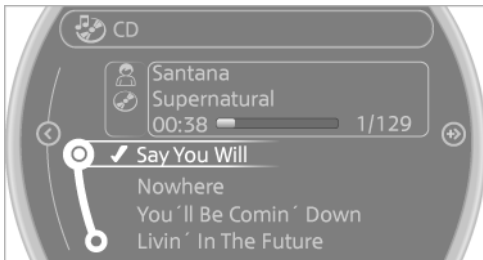

2. Select the desired track to begin playback.

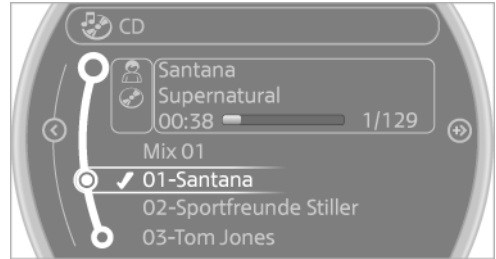

Displaying information on the track

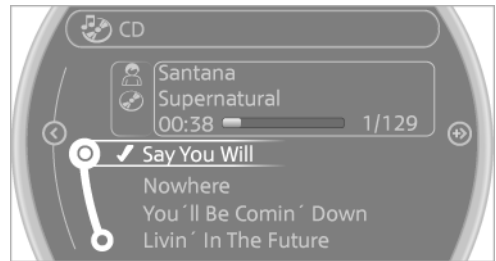

If information about a track has been stored, it is displayed automatically:

- ▷ Artist.
- ▷ Album track.
- ▷ Number of tracks on the CD.
- ▷ File name of track.

Random playback

1. "CD/Multimedia"
2. "CD"
3. Select the desired CD.

4. Open "Options".
5. "Random"

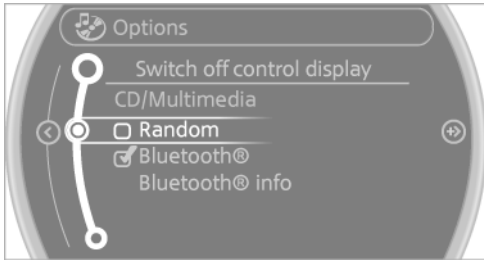

To switch off random playback: press the MINI joystick.

Fast forward/reverse



Press and hold the button for the corresponding direction.

Automatic repeat

The selected track, directories, or CDs are repeated automatically.

Information

CD player



WARNING

CD/DVD players and changers are officially designated Class 1 laser products. Lasers can damage the retina of the eye. There is risk of injuries. Do not use the CD/DVD player or changer, if the cover is damaged. ◀

CDs



CAUTION

With use of non-compatible CD sizes, the CD can get jammed and it may not be possible to pull it out again. Labels applied after the fact can loosen during playback. There is risk of property damage.

- ▷ Do not use any CDs with labels applied after the fact.

- ▷ Only use round CDs with a standard diameter of 4.7 inches/12 cm and do not play back any CDs with adapters, e.g. single CDs.
- ▷ Do not use any combined CD/DVDs, e. g. DVD Plus. ◀

General malfunctions

- ▷ The CD players have been optimized for performance in vehicles. In some instances they may be more sensitive to faulty CDs than stationary devices would be.
- ▷ If a CD cannot be played, first check if it has been inserted correctly.

Humidity

High levels of humidity can lead to condensation on the CD or the laser's scan lens, and temporarily prevent playback.

Malfunctions with particular CDs

If malfunctions occur only with particular CDs, this can be due to one of the following causes:

Self-recorded CDs

- ▷ Possible reasons for malfunctions with self-recorded CDs are inconsistent data creation or recording processes, or poor quality or old age of the blank CD.
- ▷ Only label CDs on the upper side with a pen intended for this purpose.

Damage

- ▷ Avoid fingerprints, dust, scratches and moisture.
- ▷ Store CDs in a sleeve.
- ▷ Do not subject CDs to temperatures over 50 °C/122 °F, high humidity, or direct sunlight.

CDs with copy protection

CDs are often provided with a copy protection feature by the manufacturer. This can mean

that some CDs cannot be played or can only be played to a limited extent.





MACROVISION

This product contains copyrighted technology that is based on multiple registered US patents and the intellectual property of the Macrovision Corporation and other manufacturers. The use of this copy protection must be approved by Macrovision. Media protected by this product - unless otherwise agreed with Macrovision - may only be used for private purposes. Copying of this technology is prohibited.

EXTERNAL DEVICES

Overview

Various external devices can be connected with the vehicle. Depending on how the device is connected to the vehicle, it may be possible to operate it using the MINI joystick.

Symbol	Meaning
	AUX-IN port
	USB audio interface
	Music interface for smartphones
	Bluetooth audio

AUX-IN port

Overview

- ▶ For connecting audio devices, e.g., MP3 player. The sound is output on the vehicle loudspeakers.
- ▶ Recommendation: use medium tone and volume settings on the audio device. The tone depends on the quality of the audio files.

Connecting



The AUX-IN port is in the center console.

Connect the headphone connector or line-out connector of the device to the AUX-IN port.

Ensure that the connector is inserted all the way into the AUX-IN port.

Playback

1. Connect the audio device, switch it on and select a track on the audio device.
2. "CD/Multimedia"
3. If necessary, "External devices"

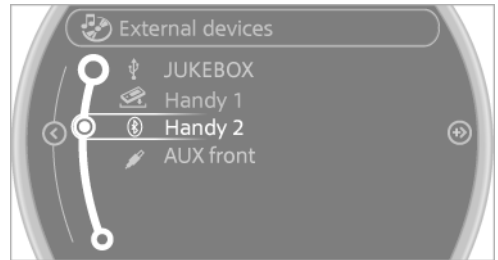

4.  "AUX front"

Sound is output on the vehicle loudspeakers.

Volume

The volume of the sound output is dependent on the audio device. If this volume differs markedly from the volume of the other audio sources, it is advisable to adjust the volumes.

Adjusting the volume

1. "CD/Multimedia"
2. If necessary, "External devices"
3.  "AUX front"

4. "Volume"

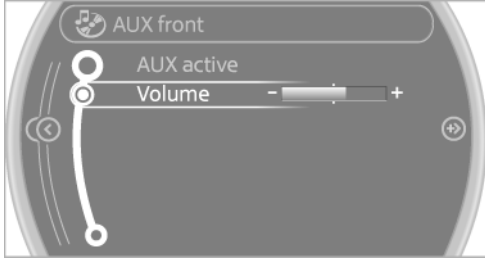

5. Turn the MINI joystick until the desired volume is set and press the MINI joystick.

USB audio interface/music interface for smartphones

Overview

It is possible to connect external audio devices. They are operated via the onboard monitor. The sound is output on the vehicle loudspeakers.

Connectors for external devices

- ▷ Connection via USB audio interface: Apple iPod/iPhone, USB devices, e.g., MP3 players, USB flash drives, or mobile phones that are supported by the USB audio interface.
- ▷ Connection via snap-in adapter, when equipped with the music interface for smartphones: Apple iPhone or mobile phones.

Playback is only possible if no audio device is connected to the analog AUX-IN port.

Due to the large number of different audio devices available on the market, it cannot be ensured that every audio device/mobile phone is operable on the vehicle.

Ask a dealer's service center or another qualified service center or repair shop about compatible audio devices/mobile phones.

Audio files

Standard audio files can be played back:

- ▷ MP3.
- ▷ WMA.
- ▷ WAV (PCM).
- ▷ AAC, M4A.
- ▷ Without the voice activation system: playback lists: M3U
- ▷ With the voice activation system: playback lists: M3U, WPL, PLS

Video files

Standard video files can be played back with a compatible Apple device:

- ▷ MPEG4
- ▷ H.264

File system

Standard file systems for USB devices are supported. The FAT 32 format is recommended.

Connecting



The USB audio interface is in the center console.

Connection of Apple iPod/iPhone via USB audio interface

To connect the iPod, use the special cable adapter for the Apple iPod. Further information is available from a dealer's service center or another qualified service center or repair shop or on the Internet: www.mini.com/connectivity
Connect the Apple iPod/iPhone with the AUX-IN port and USB interface.

The Apple iPod/iPhone menu structure is supported by the USB audio interface.

Connection of a USB device via the USB audio interface

Connect using a flexible adapter cable to protect the USB audio interface and the USB device against physical damage.

Connect the USB device to the USB interface.

After connecting for the first time

Information on all music tracks, e.g. artist or type of music, as well as playback lists are transmitted into the vehicle. This may take some time, depending on the USB device and the number of tracks.

During transmission, the tracks can be called up via the file directory.



Number of tracks

Information from up to four USB devices or for approx. 26,000 tracks can be stored in the vehicle. If a fifth device is connected or if more than 26,000 tracks are stored, information on existing tracks may be deleted.

Copy protection

Music tracks with integrated Digital Rights Management (DRM) cannot be played.

Audio playback

1. "CD/Multimedia"
2. "External devices"
3. Select the  or  symbol.

The playback starts with the first track.

The CD cover belonging to the track may appear on the Control Display after several seconds.

Track search



Selection is possible via:

- ▶ Playback lists.
- ▶ Information: type of music, artist, and, if available, composer, album, track.

- ▶ Additionally for USB devices: file directory, composer.

Tracks are displayed if they have been saved in the Latin alphabet.

Starting the track search

1. "CD/Multimedia"
2. "External devices"
3. Select the  or  symbol.

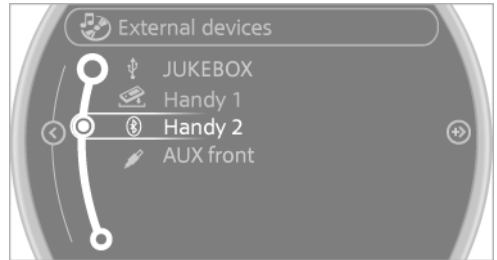

4. "Search"
5. Select the desired category, e.g., "Genre" or "Artist".

All entries are displayed in a list.

- ▶ Open "A-Z search" and input the desired entry.

When a letter is entered, the results are filtered using this letter as the first letter. If multiple letters are entered, all results that contain that sequence are displayed.

- ▶ Select the desired entry from the list.



6. Select other categories if you wish.

Not all categories need to be selected. For example, if all of the tracks by a certain artist are to be displayed, call up that artist only. All of the tracks by that artist are then displayed.



7. "Play"

Restarting a track search

"New search"



Playback lists

Calling up playback lists.

1. "CD/Multimedia"
2. "External devices"
3. Select the  or  symbol.
4. "Playlists"

Current playback

List of tracks currently being played.

1. "CD/Multimedia"
2. "External devices"
3. Select the  or  symbol.
4. "Current playback"

Random playback

The current list of tracks is played back in random order.

1. "CD/Multimedia"
2. "External devices"
3. Open "Options".
4. "Random"

Fast forward/reverse

Buttons on the steering wheel or on the CD player:



Press and hold the button for the corresponding direction.



Video playback

Overview

Video playback is only possible with a compatible iPod/iPhone. Connect using a video-capable adapter cable or, if applicable, a snap-in adapter.

Playback

The video image on the Control Display is displayed while the vehicle is stationary; in some countries, the parking brake must be set or P must be engaged.

1. "CD/Multimedia"
2. "External devices"
3. Select the  or  symbol.
4. "Video"



5. Select the desired file.
Select the category in the file directory.

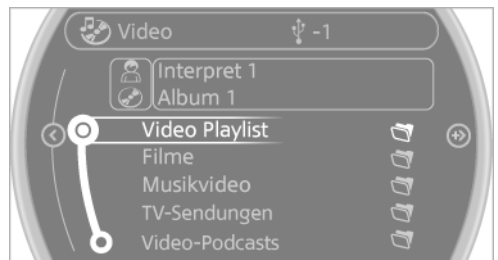

6. Press the MINI joystick.
Playback of the selected video file starts.

Information

Do not expose the audio device to extreme environmental conditions, such as very high temperatures; refer to the audio device operating instructions.

Depending on the configuration of the audio files, e.g., bit rates greater than 256 kbit/s, the files may not play back correctly in each case.

Audio and video playback from the snap-in adapter is only possible if no cable is connected to the AV-IN port.

Information on connection

- ▷ The connected audio device is supplied with a max. power of 500 mA if supported by the device. Therefore, do not additionally connect the device to a socket in the vehicle; otherwise, playback may be compromised.
- ▷ Do not use force when plugging the connector into the USB interface.
- ▷ Do not connect devices such as fans or lamps to the USB audio interface.
- ▷ Do not connect USB hard drives.
- ▷ Do not use the USB audio interface to recharge external devices.

Bluetooth audio

Overview

- ▷ Music files on external devices such as audio devices or mobile phones can be played back via Bluetooth.
Use of a mobile phone as an audio source, refer to page 190.
- ▷ Bluetooth® is a registered trademark of Bluetooth® SIG, Inc.
- ▷ The sound is output on the vehicle loudspeakers.
- ▷ The volume of the sound output is dependent on the device. If necessary, adjust the volume on the device.

- ▷ Up to four external devices can be paired with the vehicle.

Requirements

- ▷ The device is compatible. Information under www.mini.com/connectivity.
- ▷ The device is ready for operation.
- ▷ The ignition is switched on.
- ▷ Bluetooth is activated on the vehicle, refer to page 189, and on the device.
- ▷ Bluetooth presettings must be made on the device, such as for a connection without confirmation or visibility; refer to the device operating instructions.
- ▷ A number with at least four and a maximum of 16 digits is defined as the Bluetooth passkey. It is only required once for pairing.

Pairing and connecting



WARNING

Operating the integrated information systems and communication devices while driving can distract from traffic. It is possible to lose control of the vehicle. There is risk of an accident. Only use the systems or devices when the traffic situation allows. If necessary stop and use the systems and devices while the vehicle is stationary. ◀

1. "CD/Multimedia"
2. "Bluetooth® (audio)"
3. If necessary, "Bluetooth® audio"
4. "Add new phone"

The Bluetooth name of the vehicle is displayed.



5. Perform additional steps on the device, refer to the device operating instructions: for instance, search for or connect the Bluetooth device or a new device.

The Bluetooth name of the vehicle appears on the device display.

6. Select the Bluetooth name of the vehicle on the device display.

You are prompted by the onboard monitor or device to enter the same Bluetooth passkey.

7. Enter the passkey and confirm.

or

Compare the control number on the vehicle display with the control number on the mobile phone display. Confirm the control number on the mobile phone and in the vehicle.

"OK"

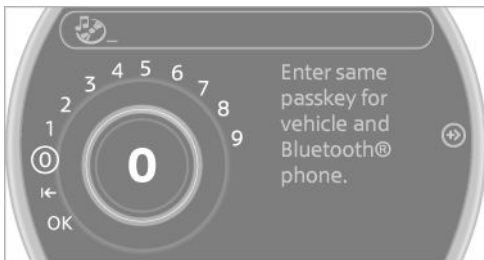

8. Select the desired functions with which the device is to be connected, for instance "Audio".

9. "OK"

If pairing was successful, the device is displayed as connected.

White symbol  : the device is active as an audio source.

If pairing was unsuccessful: What to do if..., refer to page 174.

Connecting a specific device

A device that has already been paired can be connected as an active audio source.

Connecting is not possible when data is exchanged via a mobile phone connected via Bluetooth.

Requirements

If necessary, activate the audio connection of the desired device from the list of paired devices.

1. "CD/Multimedia"
2. "Bluetooth® (audio)"
3. If necessary, "Bluetooth® audio"
4. Select the desired device from the list of paired devices.
5. Open "Options".
6. "Configure phone"
7. Activate "Audio".
8. "OK"

Connecting the device

1. "CD/Multimedia"
2. "Bluetooth® (audio)"

3. If necessary, "Bluetooth® audio"
4. Select the desired device from the list of paired devices.



White symbol  : the device is active as an audio source.

Playback

General information

- ▷ The display of music track information depends on the device.
- ▷ Operation can take place on the device or onboard monitor.
- ▷ Playback is interrupted when data is exchanged via a mobile phone connected via Bluetooth.

Starting playback

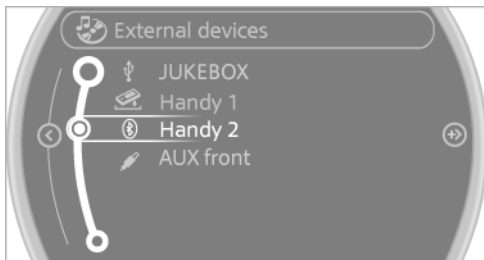

1. Connect the device.
2. "CD/Multimedia"
3. "External devices"
4.  Select the symbol.



5. Select the desired track from the list, if necessary.

Playback menu

Depending on the particular device, some of the functions may not be available.

Symbol	Function
	Next track Fast forward: press and hold the symbol.
	Previous music track Reverse: press and hold the symbol.

Track search

Music track search is possible depending on the device.

1. "CD/Multimedia"
2. "External devices"
3.  Select the symbol.
4. "Search device content"
5. "A-Z search"
6. Select the desired entry or directory.

Playback mode

Depending on the device, different programs for playing back music files might be available.

1. "CD/Multimedia"
2. "External devices"
3.  Select the symbol.
4. Open "Options".
5. Open "Select player".
6. Select the desired channel.

Disconnecting the audio connection

1. "CD/Multimedia"
2. "Bluetooth® (audio)"
3. Highlight the desired device.
4. Open "Options".
5. "Configure phone"

6. "Audio"
7. "OK"

In the case of a mobile phone, only the audio connection is disconnected. All other connections are retained.

Unpairing a device

1. "CD/Multimedia"
2. "Bluetooth® (audio)"
3. If necessary, "Bluetooth® audio"
4. Highlight the device that is to be unpaired.
5. Open "Options".
6. "Remove phone from list"

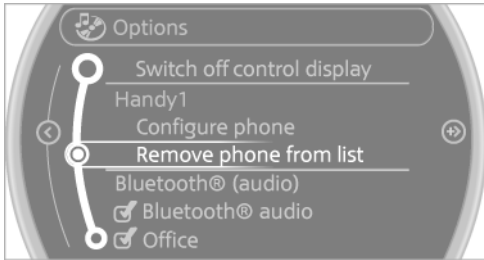

What to do if...

Information on compatible devices can be found at www.mini.com/connectivity.

Compatible mobile phones, refer to page 188.

The device is not supported by the vehicle.

- ▷ Perform a software update, refer to page 175, if needed.

The device could not be paired or connected.

- ▷ Do the Bluetooth passkeys on the device and the vehicle match? Enter the same passkey on the device and via the onboard monitor.
- ▷ A multi-character passkey may be needed.
- ▷ Did it take longer than 30 seconds to enter the passkey? Repeat the pairing procedure.
- ▷ Are too many Bluetooth devices connected to the device or vehicle? Delete connections with other devices if necessary.

- ▷ Is the mobile phone in power-save mode or does it have only a limited remaining battery life? Charge the mobile phone in the snap-in adapter or via a charging cable.

- ▷ Depending on the mobile phone, it is possible that only one device can be connected to the vehicle. Unpair the connected device from the vehicle and pair and connect only one device.

- ▷ The device no longer reacts? Switch the device off and on again.

- ▷ Repeat the pairing procedure.

Music cannot be played back.

- ▷ Start the program for playing back music data on the device and select a track on the device if necessary.

- ▷ Switch the radio on and off again.

Music files can only be played back softly.

- ▷ Adjust the volume settings on the device.

Videos can only be played back without audio or with delayed audio.

- ▷ Check the compatibility of the devices. Information under www.mini.com/connectivity.

Playback is disturbed when buttons are pressed or by other messages on the device.

- ▷ Switch off the button tones and other signal tones on the device.

Playback is interrupted by a telephone call or traffic bulletin and is not resumed automatically.

- ▷ Switch the radio on and off again.

Playback is not possible if the mobile phone is connected via Bluetooth Audio while it is also connected via the music interface for smartphones in the snap-in adapter.

- ▷ Disconnect one of the two connections; for example, disconnect the audio connection, refer to page 173, and restart playback.

If all points in this list have been checked and the required function is still not available, please contact the hotline or a dealer's service

center or another qualified service center or repair shop.

Software Update

The vehicle supports various external devices depending on the current software version. With a software update, the vehicle can support new mobile phones or new external device, for example.

Software updates and related current information is available at www.mini.com/connectivity.

Displaying the current version

The currently installed software is displayed.

1. "Settings"
2. "Software update"
3. "Show current version"

Updating the software

The software may only be updated when the vehicle is stationary.

1. Store the file for the software-update in the main director of a USB flash drive.
2. Insert the USB flash drive into the USB audio interface in the center console. An update via the USB interface in the glove compartment is not possible.
3. "Settings"
4. "Software update"
5. "Update software"

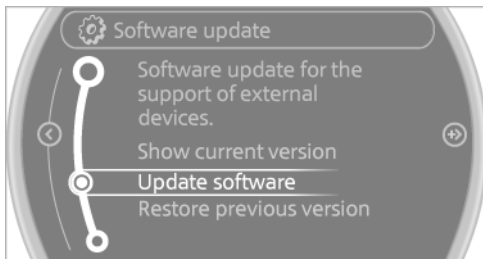

6. "Start update"
7. "OK"

All listed software updates are installed.

Restoring the previous version

The software version prior to the last software update can be restored.

The previous version can only be restored when the vehicle is stationary.

1. "Settings"
2. "Software update"
3. "Restore previous version"
4. "OK" Double-click.

All listed software updates are removed.

Note

While the software is being updated or a previous version is being restored, MINI Connected, Office functions, and the connected devices are temporarily unavailable. Wait several minutes for the functions to become available again.



CONNECT ME.

AT A GLANCE

CONTROLS

DRIVING TIPS

NAVIGATION

ENTERTAINMENT

COMMUNICATION

MOBILITY

REFERENCE

BLUETOOTH HANDS-FREE SYSTEM

VEHICLE FEATURES AND OPTIONS

This chapter describes all standard, country-specific and optional features offered with the series. It also describes features that are not necessarily available in your car, e. g., due to the selected options or country versions. This also applies to safety-related functions and systems.

When using the features and systems described here, adhere to local regulations.

OVERVIEW

The concept

Mobile phones can be connected with the vehicle via Bluetooth.

Bluetooth® is a registered trademark of Bluetooth® SIG, Inc.

After these devices are paired once, they are recognized automatically when the ignition is switched on as soon as they are in the vehicle and can then be operated via the onboard monitor, using the buttons on the steering wheel, and via voice activation.

Up to four external devices can be paired.

Certain functions may need to be enabled by the mobile phone provider or service provider.



WARNING

Operating the integrated information system and communication devices while driving can distract from traffic. It is possible to lose control of the vehicle. There is risk of an accident. Only use the systems or devices when the traffic situation allows. If necessary stop and use the systems and devices while the vehicle is stationary. ◀

Compatible mobile phones

Details on which mobile phones are supported by the hands-free system can be obtained at www.mini.com/connectivity.

Displaying the vehicle identification number and software part number

The vehicle identification number and software part number are needed to determine which mobile phones are supported by the mobile phone preparation package. The software version of the mobile phone may also be required.

1. "Telephone"
2. Open "Options".
3. "Bluetooth® info"
4. "Display system information"

These compatible mobile phones, with a certain software version, support the vehicle functions described below.

Malfunctions may occur with other mobile phones or software versions.

Do not operate a mobile phone that is connected to the vehicle on the mobile phone keypad, as this may lead to a malfunction.

Information

At high temperatures, the charging function of the mobile phone may be limited and functions may not be executed.

When using the mobile phone via the vehicle, note the operating instructions of the mobile phone.

PAIRING/UNPAIRING THE MOBILE PHONE

Requirements

- ▶ The mobile phone is compatible, refer to page 178.
- ▶ The mobile phone is ready for operation.
- ▶ Bluetooth is activated in the vehicle and on the mobile phone.
- ▶ Bluetooth presettings may need to be made on the mobile phone, e.g., for a connection without confirmation or visibility, refer to the mobile phone operating instructions.
- ▶ Deactivate Bluetooth audio if necessary.
- ▶ A number with at least four and a maximum of 16 digits was defined as the Bluetooth passkey. It is only required once for pairing.
- ▶ Compare the control number on the Control Display with the control number on the mobile phone display. Confirm the control number on the mobile phone and in the vehicle.
- ▶ The radio ready state is switched on.

Activating/deactivating Bluetooth

Bluetooth is not permitted everywhere. Comply with all safety guidelines and regulations.

1. "Telephone"
2. Open "Options".
3. "Bluetooth®"



Pairing and connecting a mobile phone

WARNING

Operating the integrated information system and communication devices while driving can distract from traffic. It is possible to lose control of the vehicle. There is risk of an accident. Only use the systems or devices when the traffic situation allows. If necessary stop and use the systems and devices while the vehicle is stationary. ◀

1. "Telephone"
2. "Bluetooth® (phone)"
3. "Add new phone"

The Bluetooth name of the vehicle is displayed.



4. To perform additional steps on the mobile phone, refer to the mobile phone operating instructions: for instance, search for or connect the Bluetooth device or a new device. The Bluetooth name of the vehicle appears on the mobile phone display.
 5. Select the Bluetooth name of the vehicle on the mobile phone display.
 6. You are prompted by the onboard monitor or mobile phone to enter the same Bluetooth passkey. Enter the passkey and confirm.
- or

Compare the control number on the vehicle display with the control number on the mobile phone display. Confirm the control number on the mobile phone and in the vehicle.

"OK"

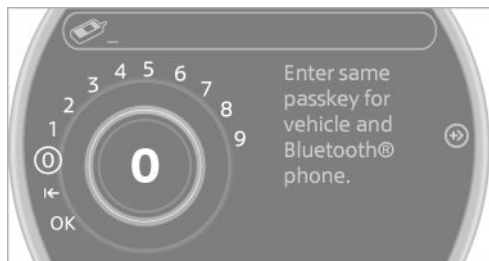

7. Select the functions for which the mobile phone is to be used.
8. "OK"
9. Move the MINI joystick to the left.

If the pairing was successful, the mobile phone appears at the top of the list of mobile phones.

If pairing was unsuccessful: What to do if..., refer to page 180.

Following the initial pairing

- ▷ The mobile phone is detected/connected in the vehicle within a short period of time when the engine is running or the ignition is switched on.
- ▷ The phone book entries of the telephone stored on the SIM card or mobile phone are transmitted to the vehicle after detection, depending on the mobile phone.
- ▷ Four mobile phones can be paired.
- ▷ Specific settings may be necessary in some mobile phones, e.g., authorization or a secure connection; refer to the mobile phone operating instructions.

Connecting a particular mobile phone

1. "Telephone"
2. "Bluetooth® (phone)"
All paired mobile phones are listed.

3. Select the mobile phone that is to be connected.



Unpairing the mobile phone

1. "Telephone"
2. "Bluetooth® (phone)"
All paired mobile phones are listed.
3. Highlight the mobile phone that is to be unpaired.
4. Open "Options".
5. "Remove phone from list"

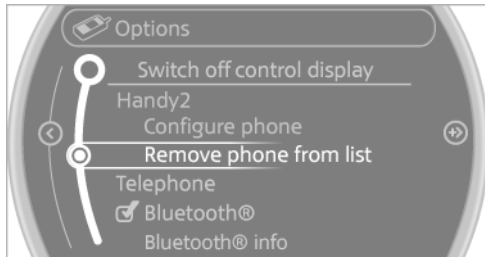

What to do if...

Information on compatible mobile phones, refer to page 178.

The mobile phone could not be paired or connected.

- ▷ Is Bluetooth activated in the vehicle and on the mobile phone? Activate Bluetooth in the vehicle and on the mobile phone.
- ▷ Do the Bluetooth passkeys on the mobile phone and the vehicle match? Enter the same passkey on the mobile phone and via the onboard monitor.

- ▷ A multi-character passkey may be needed.
- ▷ Did it take longer than 30 seconds to enter the passkey? Repeat the pairing procedure.
- ▷ Are too many Bluetooth devices connected to the mobile phone or vehicle? Delete connections with other devices if necessary.
- ▷ The mobile phone is in power-save mode or has only a limited remaining battery life. Charge the mobile phone via the charging cable.
- ▷ Depending on the mobile phone, it is possible that only one mobile phone can be connected to the vehicle. Unpair the connected mobile phone from the vehicle and pair and connect only one mobile phone.

The mobile phone no longer reacts.

- ▷ Switch the mobile phone off and on again.
- ▷ Is the ambient temperature too high or low? Do not expose the mobile phone to extreme environmental conditions.

No phone book entries or only some phone book entries are displayed, or they are incomplete.

- ▷ Transmission of the phone book entries is not yet complete.
- ▷ It is possible that only the phone book entries of the mobile phone or the SIM card are transmitted.
- ▷ It may not be possible to display phone book entries with special characters.
- ▷ The number of phone book entries to be stored is too high.
- ▷ Is the data volume of the contact too large, e. g., due to stored information such as notes? Reduce the data volume of the contact.

The phone connection quality is poor.

- ▷ The strength of the Bluetooth signal on the mobile phone can be adjusted, depending on the mobile phone.
- ▷ Place the mobile phone in the area of the center console.

If all points in this list have been checked and the required function is still not available, contact the hotline or a dealer's service center or another qualified service center or repair shop.

CONTROLS

Adjusting the volume



Turn the knob until the desired volume is selected. Settings are stored for the remote control currently in use.

Incoming call

Receiving calls

If the number of the caller is stored in the phone book and is transmitted by the network, the name of the contact is displayed. Otherwise, only the phone number is displayed.

If more than one phone number is assigned to a contact, only the name of the contact is displayed.

Accepting a call



Press the button on the steering wheel.

or



"Accept"

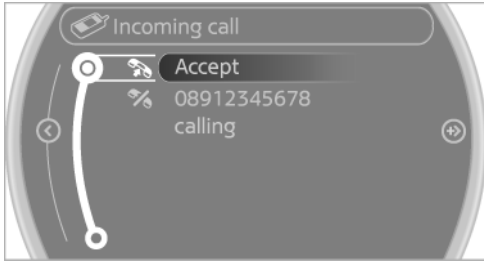

Rejecting a call

 "Reject"

Ending a call

 Press the button on the steering wheel.

or

1. "Telephone"
2.  "End call"

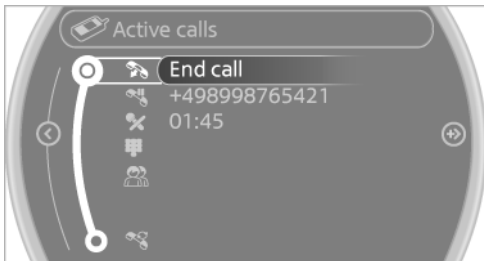

Entering a phone number

Dialing a number

1. "Telephone"
2. "Dial number"

3. Select the digits individually.
4.  Select the symbol.



The phone number can also be entered by voice.

Calls with multiple parties

General information

You can switch between calls or connect two calls to a single conference call. These functions must be supported by the mobile phone and service provider.

Accepting a call while speaking to another party

This function might have to be activated by the service provider and the mobile phone must be adjusted accordingly.

If a second call comes in during an ongoing call, a call waiting signal is sounded.

 "Accept"

The call is accepted and the existing call is put on hold.

Establishing a second call

Establish an additional call during an active call.

1. "Telephone"
2. "Active calls"
3.  "Hold"

The existing call is put on hold.



4. Dial the new phone number or select it from a list.

"Return"

The call on hold is resumed.

Switching between two calls, hold call

Active call: highlighted.

Call on hold identified by: "on hold..."

- Select the symbol to change to the call on hold.

Establishing a conference call

Two calls can be connected to a single telephone conference call.

1. Establish two calls.
2.  "Conference call"

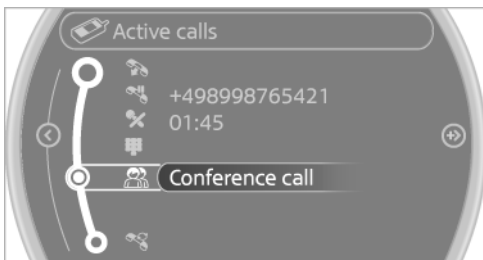

When terminating a conference call, both calls are ended. If one call is terminated by another party, the other call can be continued.

DTMF suffix dialing

DTMF suffix dialing can be used for gaining access to network services or for controlling devices,

e.g., to make a remote inquiry of an answering machine. The DTMF code is needed for this purpose.

1. "Telephone"
2. Select the contact from a list or "Dial number".
3.  "Keypad dialing"

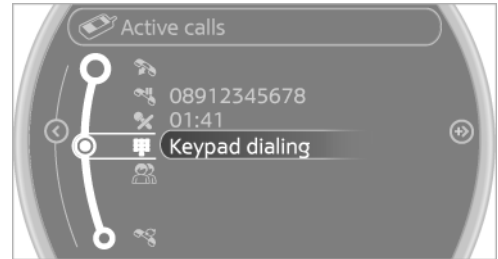

4. Enter the DTMF code on the onboard monitor.

DTMF suffix dialing is not possible during conference calls.

Phone book

Displays



The phone book accesses the contacts and shows all contacts for which a phone number has been stored. The entries can be selected to make a call.

1. "Telephone"
2. "Phone book"

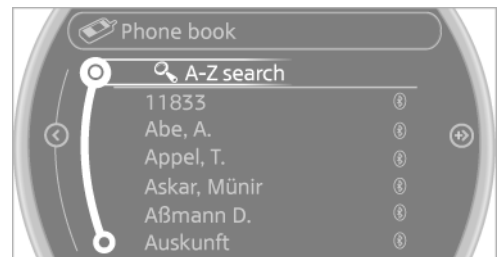
A symbol indicates the storage location of the contacts.



Calling a contact

Symbol	Meaning
	Contact with one stored phone number.
	Contact with more than one stored phone number.
	Call not possible; mobile phone without reception or network.

For contacts with one stored phone number: select the required contact. The connection is being established.

For contacts with more than one stored phone number: select the required contact and the phone number. The connection is being established.

Editing a contact

Changing the entries in "Contacts". When a contact is changed, the changes are not stored on the mobile phone. A copy of the entry is stored in the vehicle.

1. Highlight the contact.
2. Open "Options".
3. "Edit entry"

The contact can be edited.

Redialing

General information

The list of dialed numbers in the mobile phone is transmitted to the vehicle depending on the mobile phone. Possibly only those numbers are displayed that were dialed from the vehicle.

The 20 phone numbers dialed last are displayed. The sorting order of the phone numbers depends on the particular mobile phone.

Dialing a number on the onboard monitor

1. "Telephone"
2. "Redial"

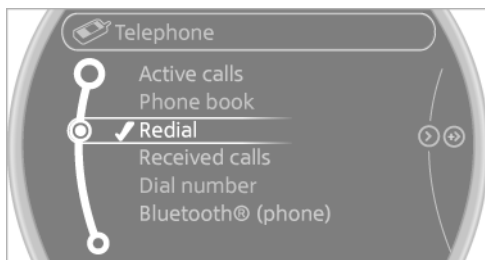

3. Select the desired entry and the phone number if necessary.

The connection is established.

Deleting a single entry or all entries

The deletion of entries depends on your particular mobile phone.

1. Highlight the entry.
2. Open "Options".
3. "Delete entry" or "Delete list"

Saving an entry in the contacts

1. Highlight the entry.
2. Open "Options".
3. "Store as new contact" or "Add to existing contact"
4. Select the contact if necessary.
5. Select the type of number: "Home", "Business", "Mobile" or "Other"
6. Complete the entries if necessary.
7. "Store contact"

Received calls

Displaying calls

The list of received calls on the mobile phone is transmitted to the vehicle, depending on the particular mobile phone. It is possible that only

those calls are displayed that were received in the vehicle.

The 20 telephone calls that were last received are displayed. The sorting order and display of the phone numbers depends on the particular mobile phone.

1. "Telephone"
2. "Received calls"

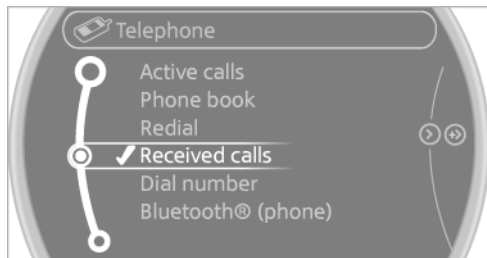

Calling a number from the list

Selecting an entry.

The connection is established.

Deleting a single entry or all entries

The deletion of entries depends on your particular mobile phone.

1. Highlight the entry.
2. Open "Options".
3. "Delete entry" or "Delete list"

Saving an entry in the contacts

1. Highlight the entry.
2. Open "Options".
3. "Store as new contact" or "Add to existing contact"
4. Select the contact if necessary.
5. Select the type of number: "Home", "Business", "Mobile" or "Other"
6. Complete the entries if necessary.
7. "Store contact"

Hands-free system

General information

Calls that are being made on the hands-free system can be continued on the mobile phone and vice versa.

From the mobile phone to the hands-free system

Calls that were begun outside of the Bluetooth range of the vehicle can be continued on the hands-free system with the ignition switched on.

Depending on the mobile phone, the system automatically switches to the hands-free system.

If the system does not switch over automatically, follow the instructions on the mobile phone display; refer also to the mobile phone operating instructions.

From the hands-free system to the mobile phone

Calls that are made on the hands-free system can in some cases be continued on the mobile phone; this depends on the mobile phone.

Follow the instructions on the mobile phone display; refer also to the mobile phone operating instructions.

CONTACTS

General information

Contacts can be created and edited.

Contacts can be created and edited and the addresses can be adopted as destinations for navigation.

New contact

1. "Contacts"
2. "New contact"

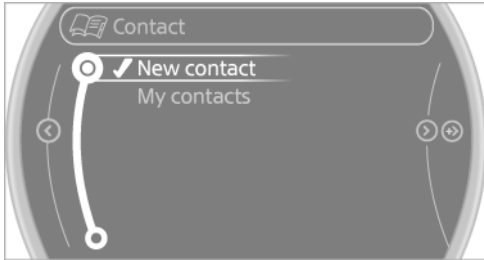

3. The entry fields are still filled with the previous entries: "Delete input fields"
4. Fill in the entry fields: select the symbol next to the entry field.



5. Enter the text, refer to page 22.
If the vehicle is equipped with a navigation system: enter the address. Only addresses contained in the navigation data in the vehicle can be entered. This ensures that destination guidance is possible for all addresses.
6. If necessary, "Store"
7. "Store contact in vehicle"

Specifying the home address

A home address can be stored. It appears at the top of the contact list.

1. "Home"
2. Create a contact.
3. "Store contact in vehicle"

My contacts

General information

List of all contacts stored in the vehicle.

Displaying contacts

1. "Contacts"
2. "My contacts"



All contacts are listed in alphabetical order. Depending on the number of contacts, an A-Z search is offered.

A symbol indicates the storage location of the contacts:

Symbol	Storage location
No symbol	In the vehicle; the address has not been checked as a destination.
	In the vehicle; the address has been checked as a destination.
	Mobile phone

Editing a contact

1. Select the desired contact.
2. "Edit contact"



3. Change the entries.
4. Move the MINI joystick to the left.
5. "Yes"

If a contact from the mobile phone is edited, the changes are not stored on the mobile phone. A copy of the entry is stored in the vehicle, and only this copy is displayed. Under certain circumstances, a contact entry with the same name is created.

Selecting the contact as a navigation destination

1. Select the desired contact.
2. Select the address.
3. "Start guidance" or "Add as another destination"

Checking the address as a destination

An address that is to be used for destination guidance must match the navigation data contained in the vehicle. The address can be checked for this purpose.

1. Select the desired contact and highlight the address.
2. Open "Options".
3. "Check as destination"
4. Correct and store the address if necessary.

Selecting the sorting order of the names

Names can be displayed in a different order.

1. "My contacts"
2. Open "Options".
3. "Display: last, first name" or "Display: first, last name"

Depending on how the contacts are stored on the mobile phone, the sorting order of the names may differ from the selected sorting order.

Deleting contacts

1. "My contacts"
2. Highlight the contact.
3. Open "Options".
4. "Delete contact" or "Delete all contacts"

BLUETOOTH MOBILE PHONE PREPARATION PACKAGE

VEHICLE FEATURES AND OPTIONS

This chapter describes all standard, country-specific and optional features offered with the series. It also describes features that are not necessarily available in your car, e. g., due to the selected options or country versions. This also applies to safety-related functions and systems.

When using the features and systems described here, adhere to local regulations.

OVERVIEW

The concept

Mobile phones or other external devices such as audio players can be connected to the vehicle via Bluetooth.

Bluetooth® is a registered trademark of Bluetooth® SIG, Inc.

After these devices are paired once, they are recognized automatically when the ignition is switched on as soon as they are in the vehicle and can then be operated via the onboard monitor, using the buttons on the steering wheel, and via voice activation.

Depending on their functionality, external devices can be used via the vehicle as a telephone or as an audio source. The telephone functions are described in the following. Operating the audio functions, refer to page 171.

Up to four external devices can be paired.

Certain functions may need to be enabled by the mobile phone provider or service provider.



WARNING

Operating the integrated information system and communication devices while driving can distract from traffic. It is possible to lose control of the vehicle. There is risk of an accident. Only use the systems or devices when the traffic situation allows. If necessary stop and use the systems and devices while the vehicle is stationary. ◀

Snap-in adapter

The snap-in adapter is used to:

- ▷ Hold the mobile phone.
- ▷ Recharge the battery.
- ▷ Connect the mobile phone to an outside antenna of the vehicle.

This provides for better network reception and consistent sound quality.

Compatible mobile phones

Displaying the vehicle identification number and software part number

The vehicle identification number and software part number are needed to determine which mobile phones are supported by the mobile phone preparation package. The software version of the mobile phone may also be required.

1. "Telephone"
2. Open "Options".
3. "Bluetooth® info"
4. "Display system information"

These compatible mobile phones, with a certain software version, support the vehicle functions described below.

Malfunctions may occur with other mobile phones or software versions.

Do not operate a mobile phone that is connected to the vehicle on the mobile phone keypad, as this may lead to a malfunction.

Information

At high temperatures, the charging function of the mobile phone may be limited and functions may not be executed.

When using the mobile phone via the vehicle, note the operating instructions of the mobile phone.

PAIRING/UNPAIRING THE MOBILE PHONE

General information

The following functions are available:

- ▷ Use of a mobile phone as a telephone.
- ▷ Use of a mobile phone as an additional telephone.
- ▷ Use of a mobile phone as an audio source.
- ▷ Use of an audio device as an audio source, refer to page 171.

Requirements

- ▷ The mobile phone is compatible, refer to page 188.
- ▷ The mobile phone is ready for operation.
- ▷ Bluetooth is activated in the vehicle and on the mobile phone.
- ▷ Bluetooth presettings may need to be made on the mobile phone, e.g., for a connection without confirmation or visibility, refer to the mobile phone operating instructions.
- ▷ Deactivate Bluetooth audio if necessary.
- ▷ Compare the control number on the Control Display with the control number on the mobile phone display. Confirm the control number on the mobile phone and in the vehicle.

- ▷ A number with at least four and a maximum of 16 digits was defined as the Bluetooth passkey. It is only required once for pairing.
- ▷ The radio ready state is switched on.

Activating/deactivating Bluetooth

Bluetooth is not permitted everywhere. Comply with all safety guidelines and regulations.

1. "Telephone"
2. Open "Options".
3. "Bluetooth@"

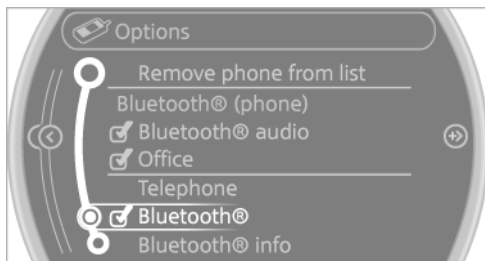

Additional functions

Activating/deactivating the additional functions

Activate the functions before pairing to be able to use them in the vehicle. Information on compatible mobile phones, refer to page 188, that support this function.

1. "Telephone"
2. "Bluetooth@ (phone)"
3. Open "Options".
4. "Configure Bluetooth@"
5. Select the desired additional function.
 - ▷ "Additional telephone"
 - ▷ "Office"
 - ▷ "Bluetooth@ audio"
6. "OK"

An additional function cannot be assigned to a telephone while it is deactivated.

Additional telephone

A mobile phone can be used as an additional telephone.

The additional telephone can be used to accept incoming calls, refer to page 194. While a call is active on the additional telephone, received calls are displayed on the Control Display.

Office

Contacts, appointments, tasks, notes, text messages, and e-mails from the mobile phone are transferred to the vehicle.

Bluetooth audio

A mobile phone can be used as an audio source.

"Bluetooth® audio"

To use a mobile phone in the vehicle as a telephone only, deactivate the function and reconnect the mobile phone.

Pairing and connecting a mobile phone



WARNING

Operating the integrated information system and communication devices while driving can distract from traffic. It is possible to lose control of the vehicle. There is risk of an accident. Only use the systems or devices when the traffic situation allows. If necessary stop and use the systems and devices while the vehicle is stationary. ◀

1. "Telephone"
2. "Bluetooth® (phone)"
3. "Add new phone"

The Bluetooth name of the vehicle is displayed.



4. To perform additional steps on the mobile phone, refer to the mobile phone operating instructions: for instance, search for or connect the Bluetooth device or a new device.

The Bluetooth name of the vehicle appears on the mobile phone display.

5. Select the Bluetooth name of the vehicle on the mobile phone display.
6. You are prompted by the onboard monitor or mobile phone to enter the same Bluetooth passkey.

Enter the passkey and confirm.

or

Compare the control number on the vehicle display with the control number on the mobile phone display. Confirm the control number on the mobile phone and in the vehicle.

"OK"



7. Select the functions for which the mobile phone is to be used.

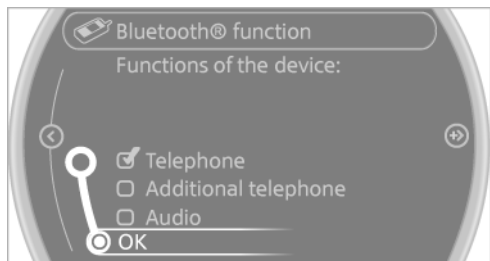

8. "OK"

9. Move the MINI joystick to the left.

If the pairing was successful, the mobile phone appears at the top of the list of mobile phones.

The functions supported by the mobile phone and audio device are displayed as symbols when paired.

White symbol: the function is active.

Gray symbol: the function is inactive.

Symbol	Function
	Telephone.
	Additional telephone.
	Audio source.

Four mobile phones can be paired with the vehicle at once. Three mobile phones can be connected with the vehicle at once.

If pairing was unsuccessful: What to do if..., refer to page 192.

Following the initial pairing

- ▷ The mobile phone is detected/connected in the vehicle within a short period of time when the engine is running or the ignition is switched on.
- ▷ The phone book entries of the telephone stored on the SIM card or mobile phone are transmitted to the vehicle after detection, depending on the mobile phone.

- ▷ Specific settings may be necessary in some mobile phones, e.g., authorization or a secure connection; refer to the mobile phone operating instructions.

Connecting a particular mobile phone

1. "Telephone"
2. "Bluetooth® (phone)"
All paired mobile phones are listed.
3. Select the mobile phone that is to be connected.



The functions assigned to the mobile phone before unpairing are assigned to the mobile phone when it is reconnected. These functions are deactivated in a mobile phone that is already connected.

Device options

Device options can be activated or deactivated for paired and connected devices.

Configuring the mobile phone

Additional functions can be activated or deactivated for paired and connected mobile phones.

1. "Telephone"
2. "Bluetooth® (phone)"
3. Highlight the mobile phone to be configured.
4. Open "Options".

5. "Configure phone"

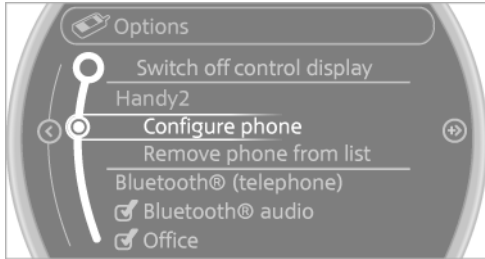

6. At least one function must be selected.

- ▷ "Telephone"
- ▷ "Additional telephone"
- ▷ "Audio"

7. "OK"

If a function has already been assigned to another connected mobile phone, the function is deactivated in that mobile phone and the mobile phone is unpaired when the function is assigned to a new mobile phone.

Swapping the telephone and additional telephone

If a phone and additional phone are connected to the vehicle, the function can be swapped between the two devices.

1. "Telephone"
2. "Bluetooth® (phone)"
3. "Swap phone/addit. phone"

Using a mobile phone as an audio source

An audio-capable mobile phone can be used as an audio source. Activate Bluetooth audio, refer to page 190.

Pair the mobile phone with the vehicle and connect it, refer to page 190.

The mobile phone is used as the audio source, provided that another device has not been connected as the audio source.

If another device has already been connected as the audio source:

1. Pair the mobile phone with the vehicle and connect it, refer to page 190.

2. "Use for audio"

The mobile phone is connected as an audio source. The previous audio source is no longer connected to the vehicle.

Unpairing a device

1. "Telephone"
2. "Bluetooth® (phone)"
All paired devices are listed.
3. Highlight the device that is to be unpaired.
4. Open "Options".
5. "Remove phone from list"

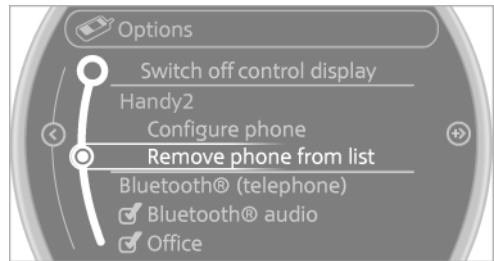

What to do if...

Information on compatible mobile phones, refer to page 188.

The mobile phone could not be paired or connected.

- ▷ Is Bluetooth activated in the vehicle and on the mobile phone? Activate Bluetooth in the vehicle and on the mobile phone.
- ▷ Do the Bluetooth passkeys on the mobile phone and the vehicle match? Enter the same passkey on the mobile phone and via the onboard monitor.
- ▷ A multi-character passkey may be needed.
- ▷ Did it take longer than 30 seconds to enter the passkey? Repeat the pairing procedure.

- ▶ Are too many Bluetooth devices connected to the mobile phone or vehicle? Delete connections with other devices if necessary.
- ▶ Is the audio connection activated? Deactivate the audio connection.
- ▶ Is the mobile phone in power-save mode or does it have only a limited remaining battery life? Charge the mobile phone in the snap-in adapter or via the charging cable.
- ▶ Depending on the mobile phone, it is possible that only one mobile phone can be connected to the vehicle. Unpair the connected mobile phone from the vehicle and pair and connect only one mobile phone.

The mobile phone no longer reacts.

- ▶ Switch the mobile phone off and on again.
- ▶ Is the ambient temperature too high or low? Do not expose the mobile phone to extreme environmental conditions.

The telephone functions are not available.

- ▶ Is the mobile phone paired as an additional telephone and is the additional telephone function deactivated? Activate the function.
- ▶ Is an outgoing call not possible? Connect the mobile phone as a telephone.

No phone book entries or only some phone book entries are displayed, or they are incomplete.

- ▶ Transmission of the phone book entries is not yet complete.
- ▶ It is possible that only the phone book entries of the mobile phone or the SIM card are transmitted.
- ▶ It may not be possible to display phone book entries with special characters.
- ▶ The number of phone book entries to be stored is too high.
- ▶ Is the data volume of the contact too large, e. g., due to stored information such as notes? Reduce the data volume of the contact.

- ▶ Is the mobile phone connected as an audio source or additional telephone? The mobile phone must be connected as a telephone.

The phone connection quality is poor.

- ▶ The strength of the Bluetooth signal on the mobile phone can be adjusted, depending on the mobile phone.
- ▶ Insert the mobile phone into the snap-in adapter or place it in the area of the center console.
- ▶ Adjust the volume of the microphone and loudspeakers separately.

If all points in this list have been checked and the required function is still not available, contact the hotline or a dealer's service center or another qualified service center or repair shop.

CONTROLS

Adjusting the volume



Turn the knob until the desired volume is selected. Settings are stored for the remote control currently in use.

The vehicle automatically adjusts the volume of the microphone on the telephone and the volume of the called party. Depending on the mobile phone, the volumes may need to be adjusted.

The settings can only be created during a call and must be adjusted separately for each tele-

phone. The settings are deleted when the telephone is unpaired.

1. "Settings"
2. "Tone"
3. "Volume settings"
4. Select the desired setting: "Microphone" or "Loudspeak."
5. To set: turn the MINI joystick.
6. To save: press the MINI joystick.

Incoming call

Receiving calls

If the number of the caller is stored in the phone book and is transmitted by the network, the name of the contact is displayed. Otherwise, only the phone number is displayed.

If more than one phone number is assigned to a contact, only the name of the contact is displayed.

For calls on the additional telephone, the number is only displayed if it is transmitted by the network.

An incoming call to one of the telephones is automatically rejected if there is an active call on the other telephone.

Accepting a call

 Press the button on the steering wheel.

or

 "Accept"

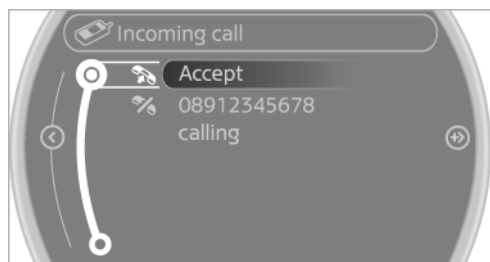

Rejecting a call

 "Reject"

The caller is redirected to the mailbox if the mailbox was activated

Ending a call

 Press the button on the steering wheel.

or

1. "Telephone"
2.  "End call"

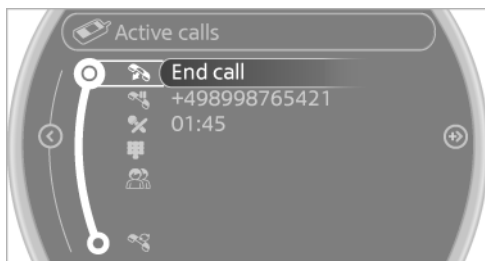

Entering a phone number

Dialing a number

1. "Telephone"
2. "Dial number"
3. Select the digits individually.
4.  Select the symbol.



The phone number can also be entered by voice.

Calls with multiple parties

General information

You can switch between calls or connect two calls to a single conference call. These functions must be supported by the mobile phone and service provider.

Accepting a call while speaking to another party

This function might have to be activated by the service provider and the mobile phone must be adjusted accordingly.

If a second call comes in during an ongoing call, a call waiting signal is sounded.

 "Accept"

The call is accepted and the existing call is put on hold.

Establishing a second call

Establish an additional call during an active call.

1. "Telephone"
2. "Active calls"
3.  "Hold"

The existing call is put on hold.

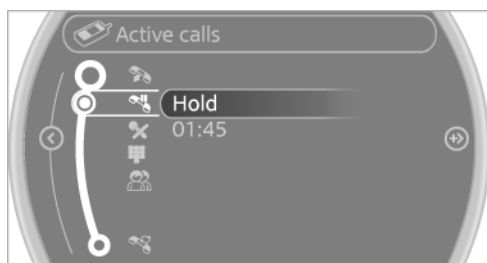

4. Dial the new phone number or select it from a list.

"Return"

The call on hold is resumed.

Switching between two calls, hold call

Active call: highlighted.

Call on hold identified by: "on hold...".

 Select the symbol to change to the call on hold.

Establishing a conference call

Two calls can be connected to a single telephone conference call.

1. Establish two calls.
2.  "Conference call"

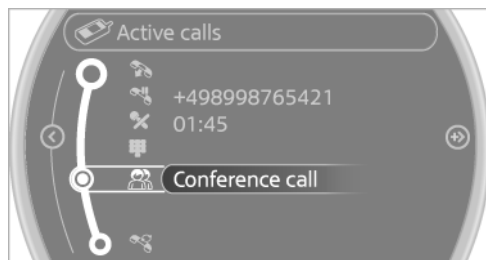

When terminating a conference call, both calls are ended. If one call is terminated by another party, the other call can be continued.

Switching the microphone to mute

When a call is active, the microphone can be muted.

1. "Telephone"
2. "Active calls"
3.  "Microphone mute"

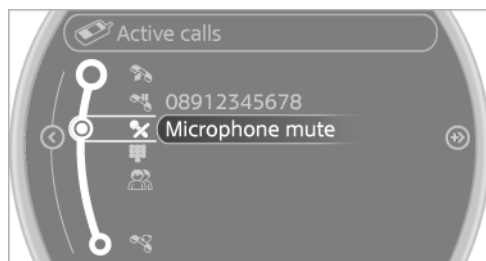

A microphone that has been switched to mute is automatically reactivated:

- ▷ When a new connection is established.
- ▷ When switching between call parties.

DTMF suffix dialing

DTMF suffix dialing can be used for gaining access to network services or for controlling devices, e.g., to make a remote inquiry of an answering machine. The DTMF code is needed for this purpose.

1. "Telephone"
2. Select the contact from a list or "Dial number".
3.  "Keypad dialing"

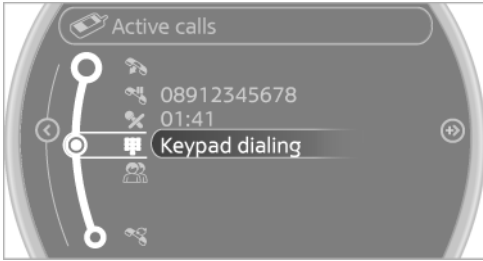

4. Enter the DTMF code on the onboard monitor.

DTMF suffix dialing is not possible during conference calls.

Phone book

Displays



The phone book accesses the contacts and shows all contacts for which a phone number has been stored. The entries can be selected to make a call.

1. "Telephone"
2. "Phone book"

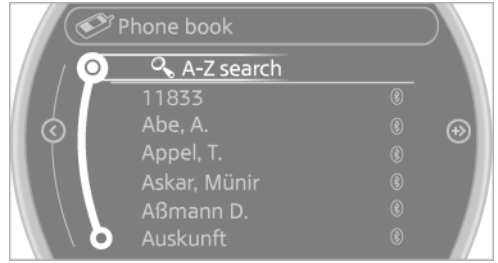
A symbol indicates the storage location of the contacts.



Calling a contact

Symbol	Meaning
	Contact with one stored phone number.
	Contact with more than one stored phone number.
	Call not possible; mobile phone without reception or network.

For contacts with one stored phone number: select the required contact. The connection is being established.

For contacts with more than one stored phone number: select the required contact and the phone number. The connection is being established.

Editing a contact

Changing the entries in "Contacts". When a contact is changed, the changes are not stored on the mobile phone. A copy of the entry is stored in the vehicle.

1. Highlight the contact.
2. Open "Options".
3. "Edit entry"

The contact can be edited.

Redialing

General information

The list of dialed numbers in the mobile phone is transmitted to the vehicle depending on the mobile phone. Possibly only those numbers are displayed that were dialed from the vehicle.

The 20 phone numbers dialed last are displayed. The sorting order of the phone numbers depends on the particular mobile phone.

Dialing a number on the onboard monitor

1. "Telephone"
2. "Redial"

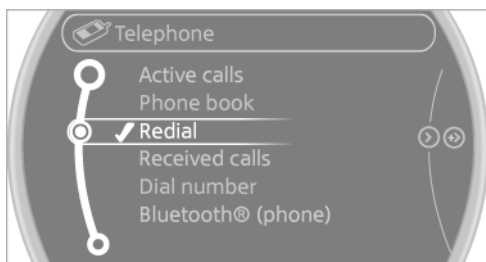

3. Select the desired entry and the phone number if necessary.

The connection is established.

Deleting a single entry or all entries

The deletion of entries depends on your particular mobile phone.

1. Highlight the entry.
2. Open "Options".
3. "Delete entry" or "Delete list"

Saving an entry in the contacts

1. Highlight the entry.
2. Open "Options".
3. "Store as new contact" or "Add to existing contact"
4. Select the contact if necessary.

5. Select the type of number: "Home", "Business", "Mobile" or "Other"
6. Complete the entries if necessary.
7. "Store contact"

Received calls

Displaying calls

The list of received calls on the mobile phone is transmitted to the vehicle, depending on the particular mobile phone. It is possible that only those calls are displayed that were received in the vehicle.

The 20 telephone calls that were last received are displayed. The sorting order and display of the phone numbers depends on the particular mobile phone.

1. "Telephone"
2. "Received calls"

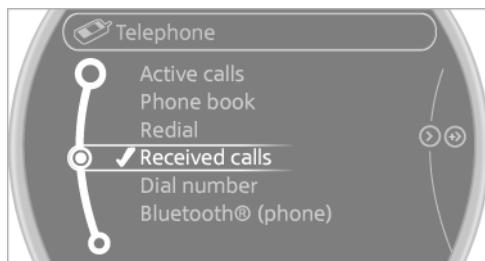

Calling a number from the list

Selecting an entry.

The connection is established.

Deleting a single entry or all entries

The deletion of entries depends on your particular mobile phone.

1. Highlight the entry.
2. Open "Options".
3. "Delete entry" or "Delete list"

Saving an entry in the contacts

1. Highlight the entry.
2. Open "Options".
3. "Store as new contact" or "Add to existing contact"
4. Select the contact if necessary.
5. Select the type of number: "Home", "Business", "Mobile" or "Other"
6. Complete the entries if necessary.
7. "Store contact"

SNAP-IN ADAPTER

General information

For more information about snap-in adapters that support the functions of the mobile phone in a compatible way, contact a dealer's service center or another qualified service center or repair shop.

Information

At high temperatures, the charging function of the mobile phone may be limited and functions may not be executed.

When using the mobile phone via the vehicle, note the operating instructions of the mobile phone.

Installation position

In the center armrest.

Inserting/removing the snap-in adapter

1. Press the button, arrow 1, and remove the cover, arrow 2.

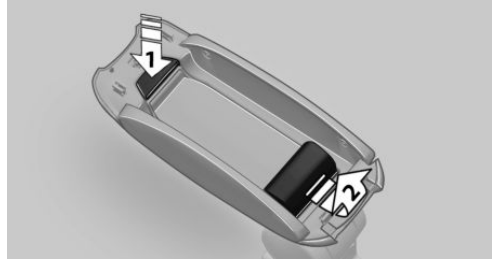

2. Insert the snap-in adapter at the front, arrow 1, and press down, arrow 2, until it engages.

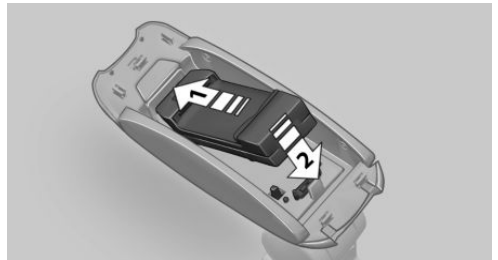

To remove:

To remove the snap-in adapter, press the button.

Inserting the mobile phone

1. Depending on the mobile phone, remove the protective cap from the antenna connector and from the USB connection of the mobile phone.
2. With the buttons facing up, slide the mobile phone up toward the electrical contacts, ar-

row 1, and press it down until it engages, arrow 2.

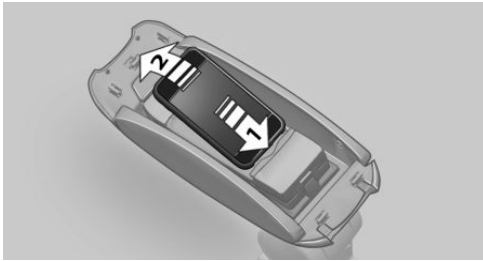

The battery is charged beginning with the radio ready state of the vehicle.

Removing the mobile phone

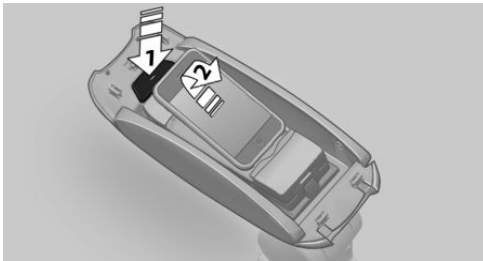

Press the button, arrow 1, and remove the mobile phone, arrow 2.

OFFICE

VEHICLE FEATURES AND OPTIONS

This chapter describes all standard, country-specific and optional features offered with the series. It also describes features that are not necessarily available in your car, e. g., due to the selected options or country versions. This also applies to safety-related functions and systems.

When using the features and systems described here, adhere to local regulations.

OVERVIEW

General information

Contacts, appointments, tasks, notes, text messages, and e-mails from the mobile phone can be displayed on the Control Display if the mobile phone provides compatible support of these functions and the necessary Bluetooth standards.

Information about which mobile phones and functions are available can be found at www.mini.com/connectivity.

Contents are only displayed in full length when the vehicle is stationary.

The mobile phone has read-access only.



WARNING

Operating the integrated information system and communication devices while driving can distract from traffic. It is possible to lose control of the vehicle. There is risk of an accident. Only use the systems or devices when the traffic situation allows. If necessary stop and use the systems and devices while the vehicle is stationary. ◀

Requirements

- ▷ A compatible mobile phone is paired with the vehicle and connected. In some mobile phones, data access must be confirmed on the mobile phone.
- ▷ The time, time zone, and date, refer to page 72, are correctly set on the Control Display and on the mobile phone, for instance to correctly display appointments.

Updating

Data are updated every time the mobile phone is connected to the vehicle. Appointment entries, tasks, notes and reminders can be updated separately.

1. "Office"
2. "Current office", "Calendar", "Tasks", "Notes" or "Reminders"
3. Open "Options".
4. "Update data"

Mobile phone data are transmitted again to the vehicle.

OFFICE INFORMATION

The number of unread messages and active tasks as well as the upcoming appointments are displayed.

1. "Office"
2. "Current office"

3. Select the desired entry to display details.

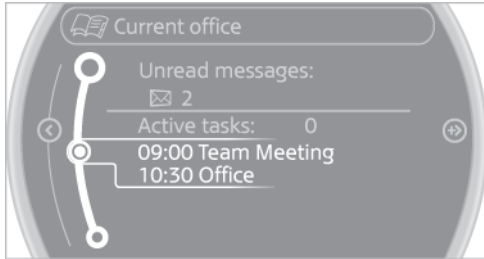

CONTACTS

Overview

Contacts can be created and edited. The contacts from the mobile phone are displayed as well if this function is supported by the mobile phone.

The addresses can be adopted as destinations for navigation and the phone numbers can be dialed.

Displaying contacts

General information

1. "Office"
2. "Contacts"

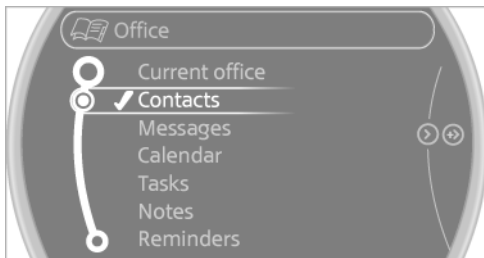

All contacts are listed in alphabetical order. Depending on the number of contacts, an A-Z search is offered.

A symbol indicates the storage location of the contacts.

Symbol	Storage location
No symbol	In the vehicle; the address has not been checked as a destination.
	In the vehicle; the address has been checked as a destination.
	Mobile phone.

Dialing a phone number

1. Select the desired contact.
2. Select the phone number.
The connection is established.

Editing a contact

1. Select the desired contact.
2. "Edit contact"

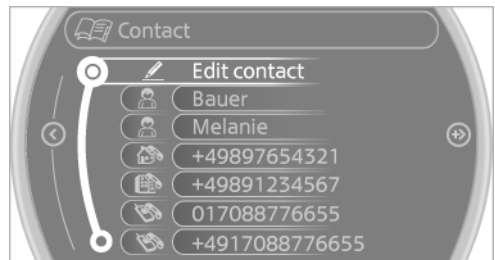

3. Change the entries.
4. "Store contact in vehicle"

When a contact is edited, the changes are not stored on the mobile phone. A copy of the entry is stored in the vehicle.

Selecting the contact as a navigation destination

1. Select the desired contact.
2. Select the address.

When contacts from the mobile phone are used, the address may need to be matched to the navigation data contained in the vehicle. In this case:

Correct the address.



3. "Start guidance" or "Add as another destination"

Checking the address as a destination

An address that is to be used for destination guidance must match the navigation data contained in the vehicle. The address can be checked for this purpose.

1. Select the desired contact and highlight the address.
2. Open "Options".
3. "Check as destination"
4. Correct and store the address if necessary.

If the address is corrected and stored, a copy of it is stored in the vehicle. The address is not changed on the mobile phone.

New contact

General information

A contact can have up to 8 phone numbers, 2 addresses, 3 e-mail addresses and one Internet address.

1. "Office"
2. "Contacts"
3. Open "Options".



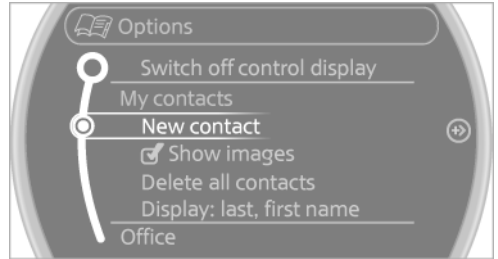



4. "New contact"



5. The entry fields are still filled with the previous entries: "Delete input fields"
6. Fill in the entry fields: select the symbol next to the entry field.
7. Enter the text and assign the contact type.
8. If the vehicle is equipped with a navigation system: enter the address. Only addresses contained in the navigation data in the vehicle can be entered. This ensures that destination guidance is possible for all addresses.
If necessary, "Accept address"
9. "Store contact in vehicle"

Contact types

Various contact types can be assigned to phone numbers and addresses.

Symbol	Meaning
	Home phone number.
	Business phone number.
	Mobile phone number.
	Other phone number.
	Home address.
	Business address.

Specifying the home address

A home address can be stored. It appears at the top of the contact list.

1. "Office"
2. "Contacts"
3. "Home"
4. Create a contact.
5. "Store contact in vehicle"

Selecting the sorting order of the names

Names can be displayed in a different order.

1. "Office"
2. "Contacts"
3. Open "Options".
4. "Display: last, first name" or "Display: first, last name"

Depending on how the contacts were stored on the mobile phone, the sorting order of the names may differ from the selected sorting order.

Show contact pictures

Pictures stored with the contacts are stored in the vehicle when the mobile phone is connected to the vehicle. The number of transmitted pictures depends on the mobile phone. The mobile phone must support this function.

1. "Office"
2. "Contacts"
3. Open "Options".
4. "Configure Bluetooth@"
5. "Show images"

Display of all contact pictures is activated or deactivated.

Deleting contacts

Only contacts that are stored in the vehicle are deleted. The contacts on the mobile phone cannot be deleted.

1. "Office"
2. "Contacts"
3. Highlight the contact.
4. Open "Options".
5. "Delete contact" or "Delete all contacts"

MESSAGES



General information

Whether or not text messages and e-mails from the mobile phone are displayed depends on whether transmission from the mobile phone to the vehicle is supported. Text messages and e-mails may not be supported by the service provider, or the function may need to be enabled separately. After the mobile phone is first paired, transmission may take several minutes. Messages are only displayed in full length when the vehicle is stationary. Messages from the additional telephone are not transmitted.

Displaying messages

1. "Office"
2. "Messages"

A symbol identifies the type of message.

Symbol	Message type
	Text messages.
	E-mail from mobile phone.

Filtering the message list

The message list can be filtered if more than one type of message exists.

1. "Filter:"
2. Select the type of message.
 - ▷ "All"

All messages are displayed.

- ▷ "Text message"
 - Only text messages from the mobile phone are displayed.
- ▷ "E-mail"
 - Only e-mails from the mobile phone are displayed.

Text messages

Calling the sender of a text message

1. Select the desired message.
2.  Select the symbol.

Saving the sender in the contacts

1. Highlight the desired message.
2. Open "Options".
3. "Store as new contact" or "Add to existing contact"

Using contact data

Contact data from appointments, tasks, text messages, e-mails, and notes can be stored or selected, refer to page [206](#).

Reading the text message out loud

Read the text message out loud, refer to page [206](#).

E-mail

Displaying e-mails

1. "Office"
2. "Messages"
3. Select the desired e-mail.

Displaying e-mail contacts

If the sender and recipient of an e-mail are transmitted by the mobile phone, this information is displayed in the e-mail.

 "Sender/Recipient"

If the e-mail addresses are stored in the contacts, the contact is displayed. Select the contact to display details.

If the e-mail addresses are not stored in the contacts, only the e-mail address is displayed.

Using contact data

Contact data from appointments, tasks, text messages, e-mails, and notes can be stored or selected, refer to page [206](#).

Deactivating the full display

When an e-mail is opened in the vehicle, the e-mail is fully transmitted to the vehicle. This may result in charges.

1. "Office"
2. "Messages"
3. Open "Options".
4. "Fully download e-mails"

Only a part of the e-mail from the mobile phone is loaded into the vehicle.

Reading the e-mail out loud

Read the e-mail out loud, refer to page [206](#).

CALENDAR

Display the calendar

Appointments during the last 20 days and the next 50 days can be displayed.

1. "Office"
2. "Calendar"

The appointments on the current day are displayed.

Selecting the calendar day

1. Select the date.

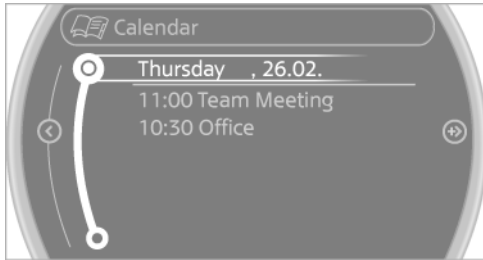

2. Select the desired day or date.
 - ▷ "Next day"
 - ▷ "Date:"
 - ▷ "Previous day"
 - ▷ "Today"

Display the appointment

1. Select the desired appointment.
2. Scroll through the appointment if necessary:
 - ▷ Turn the MINI joystick.
 - ▷ Select the symbol.

Using contact data

Contact data from appointments, tasks, text messages, e-mails, and notes can be stored or selected, refer to page 206.

Reading the appointment out loud

Read the appointment out loud, refer to page 206.

TASKS

Displaying the task list

Display tasks that are due within the next 90 days.

1. "Office"
2. "Tasks"

Sorting the task list

1. Select the header in the task list.

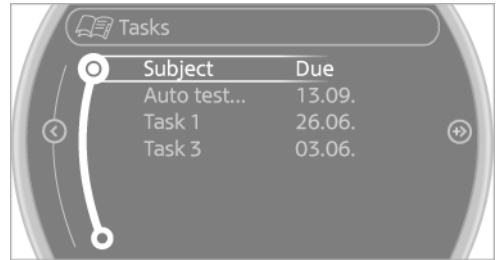

2. Select the sorting criterion:
 - ▷ "Priority (!)"
 - ▷ "Subject"
 - ▷ "Due date"

Displaying the task

1. Select the desired task.
2. Scroll in the task if necessary:
 - ▷ Turn the MINI joystick.
 - ▷ Select the symbol.

Using contact data

Contact data from appointments, tasks, text messages, e-mails, and notes can be stored or selected, refer to page 206.

Reading the task out loud

Read the task out loud, refer to page 206.

NOTES

Displaying notes

1. "Office"
 2. "Notes"
- All notes are displayed.

Displaying the note

1. Select the desired note.

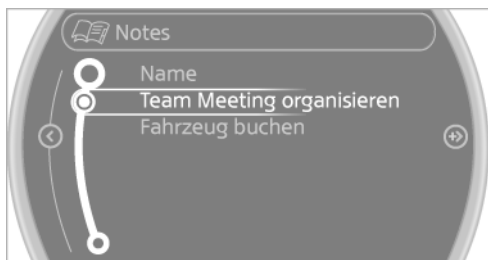

2. Scroll in the note if necessary:
 - ▶ Turn the MINI joystick.
 - ▶ Select the symbol.

Using contact data

Contact data from appointments, tasks, text messages, e-mails, and notes can be stored or selected, refer to page [206](#).

Reading the note out loud

Read the note out loud, refer to page [206](#).

REMINDERS

Displaying reminders

Reminders of pending appointments and tasks are displayed. After an appointment or after a task is due, the reminder is no longer displayed.

1. "Office"
2. "Reminders"
3. Select the desired reminder.

The corresponding appointment or the task are displayed.

USING CONTACT DATA

Overview

Contact data from appointments, tasks, text messages, e-mails, and notes can be stored or selected.

Displaying contact or selecting phone number

1. "Use contact data"

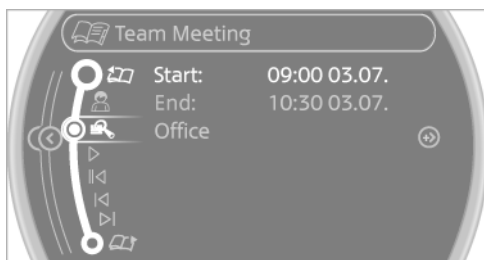

2. Display the contact or select the phone number:
 - ▶ Select the contact to display contact details.
 - ▶ Select the phone number to establish a connection directly.

Storing contact data

1. "Use contact data"
2. Highlight the phone number or e-mail address.
3. Open "Options".
4. "Add to existing contact" or "Store as new contact"

READING OUT LOUD

Text messages, e-mails, appointment entries, tasks, and notes can be read out loud.

1. Select the desired message, appointment, task, or note.
2. Select the symbol.

The following options are available during reading:

- ▷ **||** "Pause"
Interrupt reading. Select again to restart reading.
- ▷ **⏮** "Back to beginning"
Start reading the message again from the beginning.
- ▷ **⏪** Select the symbol.
Go back one paragraph.
- ▷ **⏩** Select the symbol.
Skip a paragraph.
- ▷ To end reading, move the MINI joystick to the left.

WHAT TO DO IF...

Information on compatible mobile phones, refer to page [188](#).

Appointments, tasks, notes, text messages, or e-mails from the mobile phone are not displayed.

- ▷ The mobile phone is not compatible for the missing function or is not connected correctly.
- ▷ The Office function is deactivated.
- ▷ The mobile phone is connected as an additional phone.
- ▷ Appointments are older than 20 days or are more than 50 days in the future.
- ▷ The tasks have been marked as completed or have a due date that lies more than 90 days in the future.
- ▷ Depending on the number of stored appointments, task notes, and messages in the mobile phone, not all are displayed in the vehicle.

Not all appointments and tasks from the mobile phone are displayed at the right time?

- ▷ The time zone, time, or date is incorrectly set on the Control Display and mobile phone.

Entries are not displayed in full length.

- ▷ Text were already transmitted from the mobile phone in a shortened form.
- ▷ Synchronization between the mobile phone and vehicle may take several minutes.

The contact pictures are not being displayed?

- ▷ Up to 200 contact pictures can be stored in the vehicle.

If all points in this list have been checked and the required function is still not available, please contact the hotline or a dealer's service center or another qualified service center or repair shop.

MINI CONNECTED

VEHICLE FEATURES AND OPTIONS

This chapter describes all standard, country-specific and optional features offered with the series. It also describes features that are not necessarily available in your car, e. g., due to the selected options or country versions. This also applies to safety-related functions and systems.

When using the features and systems described here, adhere to local regulations.

OVERVIEW

The concept

Certain software applications of a compatible mobile phone can be integrated in the vehicle. These software applications are displayed on the Control Display.

They are operated via the onboard monitor.

The scope of the software applications may vary by country.

Requirements

- ▷ The mobile phone is compatible.
- ▷ The mobile phone operating system supports the software applications of MINI Connected.
- ▷ Software applications are installed on the mobile phone and ready to use.
- ▷ Corresponding mobile wireless contract.
Any additionally incurred costs are not a part of MINI Connected.

The manufacturer of your vehicle recommends the use of MINI recommended apps; otherwise there may be malfunctions in system operations.

Information about compatible mobile phones, available software applications and their installation can be found at www.mini.com/connectivity or at a dealer's service center or at another qualified service center or repair shop.



WARNING

Operating the integrated information system and communication devices while driving can distract from traffic. It is possible to lose control of the vehicle. There is risk of an accident. Only use the systems or devices when the traffic situation allows. If necessary stop and use the systems and devices while the vehicle is stationary. ◀

CONNECTING THE MOBILE PHONE

Connection via the USB audio interface



The USB audio interface is in the center console.

Connect the mobile phone with a special adapter, available from a dealer's service center or another qualified service center or repair shop, with the USB port and the AV-In port.

To perform additional steps on the mobile phone, refer to the mobile phone operating instructions: for instance, selecting and activating software applications.



Connection via the snap-in adapter

The mobile phone can also be connected, refer to page 198, via the snap-in adapter.

OPERATING MINI CONNECTED

After the mobile phone is successfully connected with the vehicle and MINI Connected is started, the applications are displayed on the Control Display and can be operated using the MINI joystick.

Adjust the volume using the following:

- ▷   Buttons on the steering wheel or
 - ▷ Volume button on the radio, refer to page 156.
1. Connect the mobile phone via the snap-in adapter or via the USB audio interface.

2.  Press the button. The main menu is opened.
3. "MINI Connected"

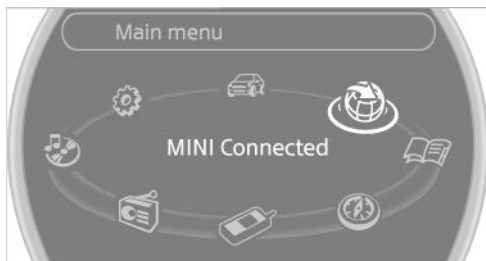

4. Select the desired software application.

Information

- ▷ The scope of MINI Connected that can be displayed on the Control Display depends on the range of software applications installed on the mobile phone.
- ▷ The data transmission of the software applications from the mobile phone to the vehicle can last some time. Some software applications depend on the speed of the available Internet connection of the mobile phone.

- ▷ Some mobile phones cannot simultaneously use MINI Connected and the Bluetooth hands-free system.

If necessary, restart the software application on the mobile phone after a phone conversation.

- ▷ Audio and video playback from the snap-in adapter is only possible if no cable is connected to the AV-IN port.

PLUGIN

The concept

Selected functions of a compatible Apple device can be displayed on the Control Display via a video connection. They are operated using the MINI joystick and the button on the MINI joystick.

Functional requirement

- ▷ Compatible iPhone or iPod: as of iPhone 3GS or iPod with software version iOS 4.1 and higher.
- ▷ The MINI Connected app is not required.

Information on compatible adapters and interfaces is available from a dealer's service center or another qualified service center or repair shop.

Activating

1. Connect the Apple device.
Operation takes place via the MINI joystick with its buttons.
2. "MINI Connected"
3. "PlugIn"
4. Select the connection type: "Activate via AUX connection" or "Activate via Snap-In adapter"

5. "Activate PlugIn"
6. Use the MINI joystick to navigate among the displayed functions and select, for example, a desired category or track.

Controls

The PlugIn is activated to display the graphic output of the connected device on the Control Display. This changes the operating functions of the MINI joystick and the MINI buttons until the PlugIn is deactivated again.

The operation of the PlugIn depends on the iOS version in use, e.g., iOS 4.1.

Home button



Press the button to select the following functions:

- ▷ Press 1x: opens the display menu bar.
- ▷ Press 2x: opens the main menu.
- ▷ Press 1x and move the MINI joystick to the left 1x: opens the MINI Connected menu.
- ▷ Press 1x and move the MINI joystick to the left 2x: opens the main menu.

Toggle button



Press the button to select the following functions.

- ▷ Press 1x: return to the next higher menu level of the iPhones/iPods.

MINI joystick

- ▷ Press: selection/play/pause.
- ▷ Turn: navigate through the lists.
- ▷ Move to the left: jump to the beginning of the current music track or to the previous music track in the playback list.
- ▷ Move the left and hold: reverse.
- ▷ Move to the right: jump to the next music track in the playback list.
- ▷ Move to the right and hold: fast forward.

Deactivating

There are several methods of deactivating the PlugIn and returning to the MINI operating level.

Via the home button

- ▷ Press 1x: returns to activating the PlugIn.
- ▷ Press 2x: opens the main menu.
- ▷ Press 1x and move the MINI joystick to the left 1x: opens the MINI Connected menu.
- ▷ Press 1x and move the MINI joystick to the left 2x: Opens the main menu.

Via the audio source button



Press 1x: changes to the audio source selected last.



MOVE ME.

AT A GLANCE

CONTROLS

DRIVING TIPS

NAVIGATION

ENTERTAINMENT

COMMUNICATION

MOBILITY

REFERENCE

REFUELING

VEHICLE FEATURES AND OPTIONS

This chapter describes all standard, country-specific and optional features offered with the series. It also describes features that are not necessarily available in your car, e. g., due to the selected options or country versions. This also applies to safety-related functions and systems.

When using the features and systems described here, adhere to local regulations.

GENERAL INFORMATION

CAUTION

With a range of less than 30 miles/50 km it is possible that the engine will no longer have sufficient fuel. Engine functions are no longer ensured. There is risk of property damage. Refuel promptly. ◀

FUEL CAP

Opening

1. Open fuel filler flap.
2. Turn the fuel cap counterclockwise.
3. Place the fuel cap in the bracket attached to the fuel filler flap.

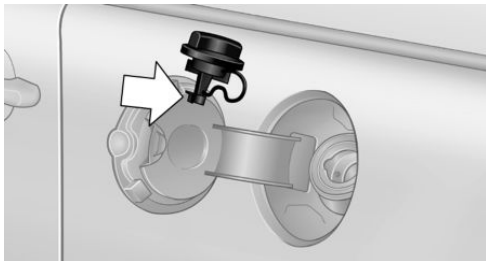

Closing

1. Fit the fuel cap and turn it clockwise until you clearly hear a click.
2. Close the fuel filler flap.

WARNING

The retaining strap of the fuel cap be jammed and crushed during closing. In this case, the lid cannot be correctly closed and fuel vapors or fuel can escape. There is risk of injuries or risk of property damage. Pay attention that the retaining strap is not jammed or crushed when closing the lid. ◀

A message is displayed if the cap is loose or missing.

Manually unlocking fuel filler flap

In the event of a malfunction, the fuel filler flap can be released manually:

MINI Countryman:

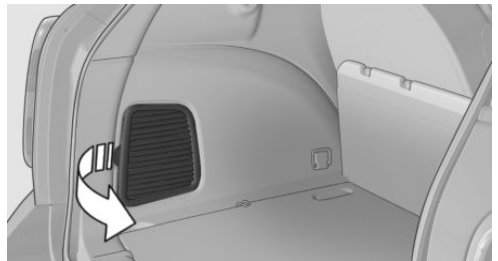

MINI Paceman:

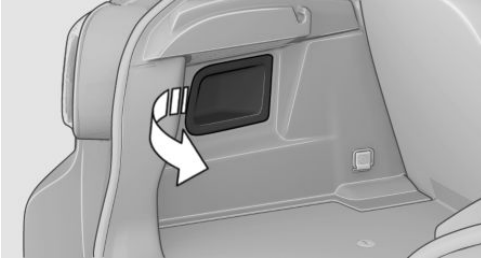

1. Open the cargo area trim, arrow.
2. Pull the green knob with the gas pump symbol.

This opens the fuel filler flap.

OBSERVE THE FOLLOWING WHEN REFUELING

When refueling, insert the filler nozzle completely into the filler pipe. Lifting up the fuel pump nozzle during refueling causes:

- ▷ Premature pump shutoff.
- ▷ Reduced efficiency in the fuel-vapor recovery system.

The fuel tank is full after refueling is resumed twice after the filler nozzle switches off for the first time.



CAUTION

Fuels are toxic and aggressive. Overfilling of the fuel tank can damage the fuel system. On contact with painted surfaces, damage may occur to these surfaces. The environment is polluted. There is risk of property damage. Avoid overfilling. ◀

Obey safety regulations posted at the gas station.

FUEL TANK CAPACITY

Approx. 12.3 US gal/47 liters, including a reserve capacity of 2.1 US gal/8 liters.

FUEL

FUEL RECOMMENDATION

Vehicle features and options

This chapter describes all standard, country-specific and optional features offered with the series. It also describes features that are not necessarily available in your car, e. g., due to the selected options or country versions. This also applies to safety-related functions and systems.

When using the features and systems described here, adhere to local regulations.

Gasoline

For the best fuel economy, the gasoline should be sulfur-free or very low in sulfur content.

Do not use fuels that are labeled at the fuel pump as containing metals.

CAUTION

Even small amounts of wrong fuel or wrong fuel additives can damage the fuel system and the engine. Furthermore, the catalytic converter is permanently damaged. There is risk of property damage. Do not refuel or add the following in the case of gasoline engines:

- ▷ Leaded gasoline.
- ▷ Metallic additives, e.g. manganese or iron.

Do not press the Start/Stop button after refueling the wrong fuel. Contact a dealer's service center or another qualified service center or repair shop.◀

Fuels with a maximum ethanol content of 10 %, i.e., E10, may be used for refueling.

The ethanol should fulfill the following quality standards:

US: ASTM 4806-xx

CAN: CGSB-3.511-xx

xx: comply with the current standard in each case.

CAUTION

Wrong fuels can damage the fuel system and the engine. There is risk of property damage. Do not use a fuel with a higher ethanol percentage than recommended or one with other types of alcohol, e.g. M5 to M100.◀

The engine is knock controlled. Therefore, you can refuel with different recommended fuel grades.

Recommended fuel grade

MINI recommends AKI 91.

John Cooper Works:

MINI recommends AKI 93.

Minimum fuel grade

MINI recommends AKI 89.

CAUTION

Fuel that does not comply with the minimum quality can compromise engine function or cause engine damage. There is risk of property damage. Do not fill with fuel that does not comply with the minimum quality.◀

If you use gasoline with this minimum AKI rating, the engine may produce knocking sounds when starting at high outside temperatures. This has no effect on the engine life.

CAUTION

The use of poor-quality fuels may result in harmful engine deposits or damage. Additionally, problems relating to drivability, starting and stalling, especially under certain environmental conditions such as high ambient temperature and high altitude, may occur.

If drivability problems are encountered, we recommend switching to a high quality gasoline brand and a higher octane grade — AKI number — for a few tank fills. To avoid harmful engine deposits, it is highly recommended to purchase gasoline from Top Tier retailers.

Failure to comply with these recommendations may result in the need for unscheduled maintenance. ◀

WHEELS AND TIRES

VEHICLE FEATURES AND OPTIONS

This chapter describes all standard, country-specific and optional features offered with the series. It also describes features that are not necessarily available in your car, e. g., due to the selected options or country versions. This also applies to safety-related functions and systems.

When using the features and systems described here, adhere to local regulations.

TIRE INFLATION PRESSURE

Safety information

It is not merely the tires' service life, but also driving comfort and, to a great extent, driving safety that depend on the condition of the tires and the maintenance of the specified tire pressure.

Checking the pressure

Tires naturally lose pressure uniformly across all four tires.



WARNING

A tire with low or missing tire inflation pressure impacts handling, such as steering and braking response. There is risk of an accident. Regularly check the tire inflation pressure, and correct it as needed, e.g. twice a month and before a long trip. ◀

Tires heat up while driving, and the tire inflation pressure increases along with the tire's temperature. The tire inflation pressure specifications apply to cold tires or tires at ambient temperature.

Only check the tire inflation pressure when the tires are cold. This means after a maximum of

1.25 miles/2 km driving or when the vehicle has been parked for at least 2 hours. When the tires are warm, the tire inflation pressure is higher.

After correcting the tire inflation pressure, reset the Tire Pressure Monitor, refer to page [88](#) or reinitialize the Flat Tire Monitor, refer to page [86](#).

Pressure specifications

The tire inflation pressure table contains all tire inflation pressure specifications for the specified tire sizes at the ambient temperature. The tire inflation pressure values apply to tire sizes approved by the manufacturer of the vehicle for the vehicle type.

For correct identification of the right tire inflation pressures, observe the following:

- ▷ Tire sizes of your vehicle
- ▷ Maximum allowable driving speed

Tire inflation pressures for driving up to 100 mph or 160 km/h

For normal driving up to 100 mph/160 km/h, adjust pressures to the respective tire inflation pressures listed on the following pages in the column for traveling speeds up to 100 mph/160 km/h to achieve optimum driving comfort.

These tire inflation pressures can also be found on the driver's side door pillar when the driver's door is open.

MINI Countryman:

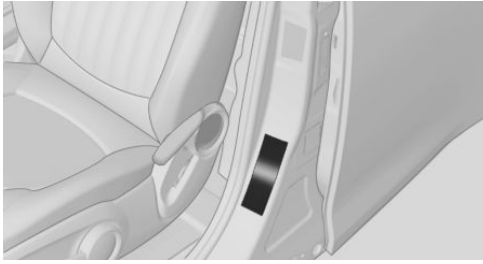

MINI Paceman:

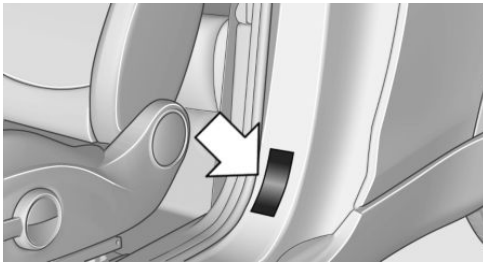

Do not exceed a speed of 100 mph/160 km/h.

Tire inflation pressures for driving above 100 mph or 160 km/h

⚠ WARNING

In order to drive at maximum speeds in excess of 100 mph/160 km/h, please observe, and, if necessary, adjust tire pressures for speeds exceeding 100 mph/160 km/h from the relevant table on the following pages. Otherwise tire damage and accidents could occur. ◀



Observe all national and local maximum speed limits; otherwise, violations of the laws could occur.

Tire inflation pressures for MINI Countryman Cooper

Tire size	Pressure specifications in bar/PSI				
	Traveling speeds of up to 100 mph/160 km/h		Traveling speeds above 100 mph/160 km/h		
All pressure specifications in the table are indicated in bar/PSI with cold tires. Cold = ambient temperature					
	195/60 R 16 89 H M+S Std	2.2/32	2.2/32	2.4/35	2.4/35
	205/55 R 17 91 H M+S RSC				
	205/55 R 17 91 H M+S A/S RSC				
	205/55 R 17 91 V RSC				
	225/45 R 18 91 V RSC				
	225/40 R 19 89 V RSC				



More details on the permissible load and weights, refer to page 261.

Tire inflation pressures for MINI Countryman Cooper S/Countryman Cooper S ALL4

Tire size	Pressure specifications in bar/PSI			
	Traveling speeds of up to 100 mph/160 km/h		Traveling speeds above 100 mph/160 km/h	
All pressure specifications in the table are indicated in bar/PSI with cold tires. Cold = ambient temperature				
195/60 R 16 89 H M+S Std	2.2/32	2.2/32	2.6/38	2.6/38
205/55 R 17 91 H M+S RSC				
205/55 R 17 91 H M+S A/S RSC				
205/55 R 17 91 V RSC				
225/45 R 18 91 V RSC				
225/40 R 19 89 V RSC				

More details on the permissible load and weights, refer to page [261](#).

Tire inflation pressures for MINI Countryman John Cooper Works

Tire size	Pressure specifications in bar/PSI			
	Traveling speeds of up to 100 mph/160 km/h		Traveling speeds above 100 mph/160 km/h	
All pressure specifications in the table are indicated in bar/PSI with cold tires. Cold = ambient temperature				
195/60 R 16 89 H M+S Std	2.4/35	2.4/35	2.6/38	2.6/38
225/45 R 18 91 V RSC				
225/45 R 18 91 V M+S A/S RSC				
225/40 R 19 89 V RSC	2.4/35	2.4/35	2.7/39	2.7/39

More details on the permissible load and weights, refer to page [261](#).

Tire inflation pressures for MINI Paceman Cooper

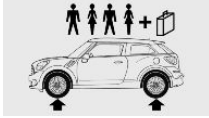
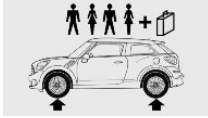
Tire size	Pressure specifications in bar/PSI			
	Traveling speeds of up to 100 mph/160 km/h		Traveling speeds above 100 mph/160 km/h	
All pressure specifications in the table are indicated in bar/PSI with cold tires. Cold = ambient temperature				
	195/60 R 16 89 H M+S Std	2.2/32	2.2/32	2.4/35
205/55 R 17 91 H M+S RSC				
205/55 R 17 91 H M+S A/S RSC				
205/55 R 17 91 V RSC				
225/45 R 18 91 V RSC				
225/40 R 19 89 V RSC				

More details on the permissible load and weights, refer to page [262](#).

Tire inflation pressures for MINI Paceman Cooper S / Paceman Cooper S ALL4

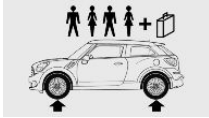
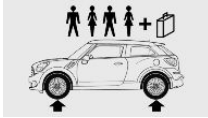
Tire size	Pressure specifications in bar/PSI			
	Traveling speeds of up to 100 mph/160 km/h		Traveling speeds above 100 mph/160 km/h	
All pressure specifications in the table are indicated in bar/PSI with cold tires. Cold = ambient temperature				
	195/60 R 16 89 H M+S Std	2.2/32	2.2/32	2.6/38
205/55 R 17 91 H M+S RSC				
205/55 R 17 91 H M+S A/S RSC				
205/55 R 17 91 V RSC				
225/45 R 18 91 V RSC				
225/40 R 19 89 V RSC				

More details on the permissible load and weights, refer to page [262](#).

Tire inflation pressures for MINI Paceman John Cooper Works

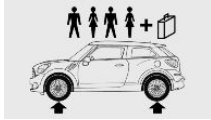
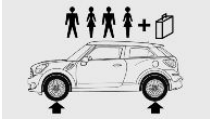
Tire size	Pressure specifications in bar/PSI			
	Traveling speeds of up to 100 mph/160 km/h		Traveling speeds above 100 mph/160 km/h	
All pressure specifications in the table are indicated in bar/PSI with cold tires. Cold = ambient temperature				
195/60 R 16 89 H M+S Std	2.4/35	2.4/35	2.7/39	2.7/39
225/45 R 18 91 V RSC				
225/45 R 18 91 V M+S A/S RSC				
225/40 R 19 89 V RSC				

More details on the permissible load and weights, refer to page [262](#).

TIRE IDENTIFICATION MARKS

Knowledge of the labeling on the side of the tire makes it easier to identify and choose the right tires.

Tire size

Example: 225/45 R 17 91 V

225: nominal width in mm

45: aspect ratio in %

R: radial tire code

17: rim diameter in inches

91: load rating, not for ZR tires

Speed letter

Q = up to 100 mph/160 km/h

T = up to 118 mph/190 km/h

H = up to 131 mph/210 km/h

V = up to 150 mph/240 km/h

W = up to 167 mph/270 km/h

Y = up to 186 mph/300 km/h

Tire Identification Number

Tires with DOT codes meet the guidelines of the U.S. Department of Transportation.

DOT code:

DOT xxxx xxx 2214

xxxx: manufacturer code for the tire brand

xxx: tire size and tire design

2214: tire age

Uniform Tire Quality Grading

Quality grades can be found where applicable on the tire sidewall between tread shoulder and maximum section width. For example:

Treadwear 200 Traction AA

Temperature A

DOT Quality Grades

Treadwear

Traction AA A B C

Temperature A B C

All passenger car tires must conform to Federal Safety Requirements in addition to these grades.

Treadwear

The treadwear grade is a comparative rating based on the wear rate of the tire when tested under controlled conditions on a specified government test course. For example, a tire graded 150 would wear one and one-half (1 1/2) times as well on the government course as a tire graded 100. The relative performance of tires depends upon the actual conditions of their use, however, and may depart significantly from the norm due to variations in driving habits, service practices and differences in road characteristics and climate.

Traction

The traction grades, from highest to lowest, are AA, A, B, and C.

Those grades represent the tire's ability to stop on wet pavement as measured under controlled conditions on specified government test surfaces of asphalt and concrete. A tire marked C may have poor traction performance.

The traction grade assigned to this tire is based on straight-ahead braking traction tests, and does not include acceleration, cornering, hydroplaning, or peak traction characteristics.

Temperature

The temperature grades are A, the highest, B, and C, representing the tire's resistance to the generation of heat and its ability to dissipate heat when tested under controlled conditions on a specified indoor laboratory test wheel. Sustained high temperature can cause the material of the tire to degenerate and reduce tire life, and excessive temperature can lead to sudden tire failure. The grade C corresponds to a level of performance which all passenger car tires must meet under the Federal Motor Vehicle Safety Standard No. 109. Grades B and A represent higher levels of performance on the laboratory test wheel than the minimum required by law.



WARNING

The temperature grade for this tire is established for a tire that is properly inflated and not overloaded. Excessive speed, underinflation, or excessive loading, either separately or in combination, can cause heat buildup and possible tire failure. ◀

RSC – Run-flat tires

The symbol identifying run-flat tires is a circle with the letters RSC on the sidewall, refer to page 226.

M+S

Winter and all-season tires.

These have better winter properties than summer tires.

XL

Designation for specially reinforced tires.

TIRE TREAD

Summer tires

The tread depth should not be less than 0.12 in/3 mm, although European legislation, for example, requires a minimum tread depth of only 0.063 in/1.6 mm. At tread depths less than 0.12 in/3 mm, there is a great danger of hydroplaning even in low water depths and at raised speeds.

Winter tires

The suitability of winter tires for winter driving is reduced noticeably when their tread depth becomes less than 0.16 in/4 mm.

Minimum tread depth



Wear indicators in the tread base are distributed around the circumference of the tire and are marked on the tire sidewall with TWI, Tread Wear Indicator. When the tire tread has been worn down to the wear indicators, a tread has reached a depth of 0.063 in/1.6 mm.

TIRE DAMAGE

General information

Inspect your tires often for damage, foreign objects lodged in the tread, and tread wear.

Information

Driving over rough or damaged road surfaces, as well as debris, curbs and other obstacles can cause serious damage to wheels, tires and suspension parts. This is more likely to occur with low-profile tires, which provide less cushioning between the wheel and the road. Be careful to avoid road hazards and reduce your speed, especially if your vehicle is equipped with low-profile tires.

Indications of tire damage or other vehicle malfunctions:

- ▷ Unusual vibrations during driving.
- ▷ Unusual handling such as a strong tendency to pull to the left or right.

Damage can be caused by driving over curbs, road damage and similar situations.

WARNING

Damaged tires can lose tire inflation pressure, which can lead to loss of vehicle control. There is risk of an accident. If tire damage is suspected while driving, immediately reduce speed and stop. Have wheels and tires checked. For this purpose, drive carefully to the nearest dealer's service center or another qualified service center or repair shop. Have vehicle towed or transported as needed. ◀

WARNING

Damaged tires can lose tire inflation pressure, which can lead to loss of vehicle control. There is risk of an accident. Do not repair damaged tires, but have them replaced. ◀

TIRE AGE

Recommendation

For several reasons, among other things because of beginning brittleness, the manufacturer of your MINI recommends mounting new tires at the latest after six years, regardless of the actual wear.

Manufacture date

The date of manufacture of the tires is specified in the tire label:

DOT ... 2015: the tire was manufactured in week 20 of 2015.

CHANGING WHEELS AND TIRES

Mounting

Have mounting and wheel balancing carried out by a dealer's service center or another qualified service center or repair shop.

Wheel and tire combination

Information on the right wheel/tire combination and wheel rim versions for your vehicle can be obtained from the dealer's service center or another qualified service center or repair shop.

Incorrect wheel and tire combinations impair the function of a variety of systems such as ABS or DSC.

To maintain good handling and vehicle response, use only tires with a single tread configuration from a single manufacturer.

Following tire damage, have the original wheel and tire combination remounted on the vehicle as soon as possible.



WARNING

Wheels and tires which are not suitable for your vehicle can damage parts of the vehicle, e.g. due to contact with the body due to tolerances despite the same official size rating. There is risk of an accident. ◀

Wheels with electronics for TPM Tire Pressure Monitor

When mounting new tires or changing from summer to winter tires or vice versa, only use wheels with TPM electronics; otherwise, the Tire Pressure Monitor will not be able to detect a flat tire, refer to page 87. A dealer's service center will be glad to answer any questions you may have.

Recommended tire brands



For each tire size, the manufacturer of your vehicle recommends certain tire brands. These can be identified by a star on the tire sidewall.

Retreaded tires



WARNING

Retreaded tires can have different tire casing structures. With advanced age the service life can be limited. There is risk of an accident. The manufacturer of your vehicle does not recommend the use of retreaded tires. ◀

Winter tires

The manufacturer of your vehicle recommends winter tires for winter roads or at temperatures below +45 °F/+7 °C.

Although so-called all-season M+S tires do provide better winter traction than summer tires, they do not provide the same level of performance as winter tires.

Maximum speed of winter tires

If the maximum speed of the vehicle is higher than the permissible speed for the winter tires, then display a corresponding sign in the field of vision. The sign is available from the tire dealer or from a dealer's service center or another qualified service center or repair shop.

With mounted winter tires, observe and adhere to the permissible maximum speed.

Run-flat tires

When mounting new tires or changing from summer to winter tires or vice versa, use run-flat tires for your own safety. Also, a compact wheel is not available in case of a flat tire. A dealer's service center will be glad to answer any questions you may have.

Rotating wheels between axles

Different wear patterns occur on the front and rear axles, depending on the individual conditions of use.

To ensure even wear on the tires, the wheels can be rotated between the axles. A dealer's service center will be glad to answer any questions you may have.

After changing the tires, check the tire inflation pressure and correct it if necessary.

Storage

Store wheels and tires in a cool, dry place with as little exposure to light as possible.

Always protect tires against all contact with oil, grease and fuels.

Do not exceed the maximum tire inflation pressure indicated on the side wall of the tire.

RUN-FLAT TIRES

Label



The symbol identifying run-flat tires is a circle with the letters RSC on the sidewall.

Run-flat tires are tires that support themselves for a limited period of time, and they may also come with special rims. The sidewall reinforcement ensures that the tire can continue to be used to a limited extent if it has lost pressure and even if it has become completely depressurized.

For continued driving in the event of a flat tire, refer to page [86](#).

CORRECTING A FLAT TIRE

Safety measures

- ▷ Park the vehicle as far as possible from passing traffic and on solid ground. Switch on the hazard warning system.
- ▷ Let the steering wheel lock engage with the wheels in the straight-ahead position, set the parking brake, and engage first gear or reverse, or engage selector lever position P.
- ▷ Have all vehicle occupants get out of the vehicle and ensure that they remain outside the immediate area in a safe place, such as behind a guardrail.
- ▷ If a warning triangle or portable hazard warning lamp is required, set it up on the roadside at an appropriate distance from the rear of the vehicle. Comply with all safety guidelines and regulations.

The procedure to correct a flat tire depends on the equipment in the vehicle:

- ▷ Run-flat tires, refer to page [226](#).
- ▷ MINI Mobility System, refer to page [226](#).

MINI MOBILITY SYSTEM

Information

- ▷ Follow the instructions on using the Mobility System found on the compressor and sealant bottle.

- ▷ Use of the Mobility System may be ineffective if tire damage is greater than approx. 1/8 in/4 mm in size.
- ▷ Contact a dealer's service center or another qualified service center or repair shop if the tire cannot be made drivable.
- ▷ If possible, do not remove foreign bodies that have penetrated the tire.
- ▷ Pull the speed limit sticker off the sealant bottle and apply it to the steering wheel.

Sealant and compressor



- 1 Sealant bottle and speed limit sticker
- 2 Filling hose

Note the use-by date on the sealant bottle.

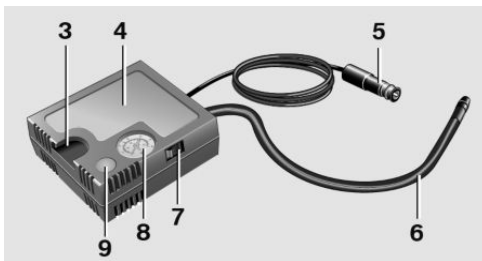

- 3 Holder for the sealant bottle
- 4 Compressor
- 5 Connector and cable for the lighter socket/ socket in passenger compartment 110.
- 6 Connection hose for connecting the compressor and sealant bottle or the compressor and wheel
- 7 On/off switch

- 8 Pressure gauge for displaying the tire inflation pressure
- 9 Release button for reducing the tire inflation pressure

The connector, cable, and connecting hose are stowed in the compressor housing.

Using the Mobility System

To repair a flat tire with the Mobility System, proceed as follows:

- ▷ Filling the tire with sealant
- ▷ Distributing the sealant
- ▷ Correcting the tire inflation pressure

Filling the tire with sealant

1. Shake the sealant bottle.
2. Pull the connection hose 6 fully out of the compressor housing and screw it onto the sealant bottle connection. Ensure that the connection hose is not kinked.
3. Insert the sealant bottle into the compressor housing in a vertical position.
4. Unscrew the dust cap off of the valve of the not working wheel and screw the filling hose 2 of the sealant bottle onto the valve.

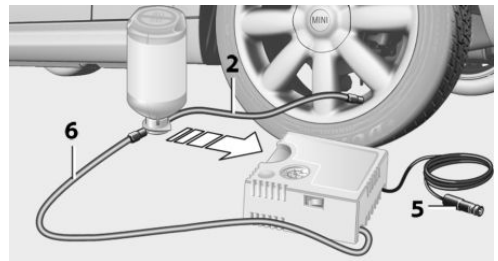

5. Ensure that the compressor is switched off.
6. Insert connector 5 into the lighter socket/ socket in the passenger compartment, refer to page 110.
7. When the engine is running:

Switch on the compressor and let it run for approx. 3 to 8 minutes to fill sealant into the tire and achieve a tire inflation pressure of approx. 1.8 bar/26 psi.

While sealant is being filled, the inflation pressure may intermittently rise to approx. 5 bar/73 psi. Do not switch off the compressor in this phase.

8. Switch off the compressor.



CAUTION

The compressor can overheat during extended operation. There is risk of property damage. Do not run the compressor for more than 10 min. ◀

If an air pressure of 1.8 bar/26 psi is not reached:

1. Unscrew the filling hose 2 from the wheel and drive forward and back approx. 33 ft/10 m to evenly distribute the sealant in the tire.
2. Inflate the tire again using the compressor.

If the inflation pressure of 1.8 bar/26 psi is still not reached, the tire is too heavily damaged. Contact a dealer's service center or another qualified service center or repair shop.

Stowing the Mobility System

1. Unscrew the filling hose 2 of the sealant bottle from the wheel.
2. Unscrew the compressor connection hose 6 from the sealant bottle.
3. Connect the filling hose 2 of the sealant bottle with the free connector on the sealant bottle.

This prevents left-over sealant from escaping from the bottle.

4. Wrap the empty sealant bottle in suitable material to avoid dirtying the cargo area.
5. Stow the Mobility System back in the vehicle.

Distributing the sealant

Drive approx. 3.1 miles/5 km to evenly distribute the sealant.

Do not exceed a speed of 50 mph/80 km/h. If possible, do not drop below a speed of 10 mph/20 km/h.

Correcting the tire inflation pressure

1. After driving approx. 3.1 miles/5 km, or about 10 minutes, stop in a suitable location.
2. Screw the connection hose 6 of the compressor directly onto the tire valve.
3. Insert the connector 5 into the power socket in the passenger compartment.
4. Correct the tire inflation pressure to 1.8 bar/26 psi. When the engine is running:
 - ▷ To increase the inflation pressure: switch on the compressor. To check the currently set inflation pressure, switch off the compressor.
 - ▷ To reduce the inflation pressure: press the release button 9.



CAUTION

The compressor can overheat during extended operation. There is risk of property damage. Do not run the compressor for more than 10 min. ◀

If the inflation pressure is not maintained, take the vehicle on another drive, distributing the sealant, refer to page 228. Then repeat steps 1 to 4 once.

If the inflation pressure of 1.8 bar/26 psi is still not reached, the tire is too heavily damaged. Contact a dealer's service center or another qualified service center or repair shop.

Continuing the trip

Do not exceed the maximum permissible speed of 50 mph/80 km/h.

Replace the not working tire as soon as possible and have the wheel balanced.

Have the Mobility System refilled.

SNOW CHAINS

The manufacturer of your vehicle recommends use of fine-link snow chains. Certain types of fine-link snow chains have been tested by the manufacturer of the vehicle and recommended as road-safe and suitable.

Information regarding suitable snow chains is available from a dealer's service center or another qualified service center or repair shop.

Use only in pairs on the front wheels, equipped with tires of the following size:

195/60 R 16 M+S

With ALL4 all-wheel drive: only mount snow chains on the front wheels.

Observe the manufacturer's instructions when mounting snow chains. Do not exceed a speed of 30 mph or 50 km/h when using snow chains.

Do not initialize the Flat Tire Monitor if snow chains are mounted; otherwise, the instrument might issue an incorrect reading.

Do not initialize the Tire Pressure Monitor if snow chains are mounted; otherwise, the instrument might issue an incorrect reading.

When driving with snow chains, it may be useful to temporarily deactivate DSC or activate DTC, refer to page [93](#).

ENGINE COMPARTMENT

VEHICLE FEATURES AND OPTIONS

This chapter describes all standard, country-specific and optional features offered with the series. It also describes features that are not

necessarily available in your car, e. g., due to the selected options or country versions. This also applies to safety-related functions and systems.

When using the features and systems described here, adhere to local regulations.

IMPORTANT FEATURES IN THE ENGINE COMPARTMENT

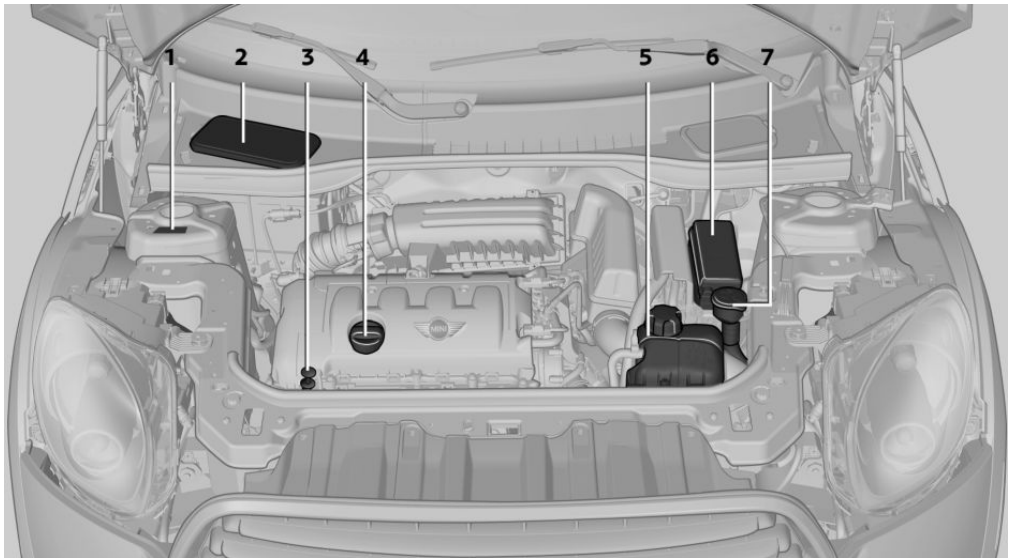

- | | |
|---|---|
| <ul style="list-style-type: none"> 1 Vehicle identification number 2 Battery, under the cover 246 3 Dip stick for engine oil 232 4 Engine oil filler neck 232 | <ul style="list-style-type: none"> 5 Coolant expansion tank 234 6 Engine compartment fuse box 247 7 Reservoir for washer fluid for the headlight and window washer system 64 |
|---|---|

HOOD

Information



WARNING

Improperly executed work in the engine compartment can damage vehicle components and impair vehicle functions. There is a risk of personal and property damage. The manufacturer of your vehicle recommends that, in the effort to avoid such risks, work in the engine compartment be performed by a dealer's service center or another qualified service center or repair shop. ◀



CAUTION

Folded-away wipers can be jammed when the hood is opened. There is risk of property damage. Make sure that the wipers with the wiper blades mounted are folded down onto the windshield before opening the hood. ◀

Unlocking and opening the hood

1. Pull the lever.

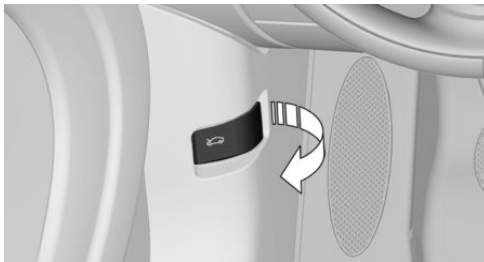

2. Lift the hood all the way.

3. Press the release handle and open the hood.



WARNING

There are protruding parts, e.g. lock hook, on the inside of the hood. There is risk of injuries. If the hood is open, pay attention to protruding parts and keep these areas clear. ◀

Closing the hood



Close the hood from a height of approx. 16 in/40 cm with momentum. It must be clearly heard to engage.



WARNING

An incorrectly locked hood can open while driving and restrict visibility. There is risk of an accident. Stop immediately and correctly close the hood. ◀



WARNING

Body parts can be jammed on opening and closing the hood. There is risk of injuries. Make sure that the area of movement of the hood is clear during opening and closing. ◀

ENGINE OIL

ENGINE OIL

Vehicle features and options

This chapter describes all standard, country-specific and optional features offered with the series. It also describes features that are not necessarily available in your car, e. g., due to the selected options or country versions. This also applies to safety-related functions and systems.

When using the features and systems described here, adhere to local regulations.

General information

Engine oil consumption depends on the driving style and the conditions of use. A highly sporty driving style, for example, results in considerably higher engine oil consumption.

Therefore, regularly check the engine oil level after refueling.

Checking the oil level with a dip stick

1. Park the vehicle on level ground when the engine is at operating temperature, i.e., after driving continuously for at least 6.2 miles/10 km.
2. Switch the engine off.
3. After approx. 5 minutes, pull out the dip stick and wipe it off with a lint-free cloth, paper towel, etc.
4. Carefully insert the dip stick all the way into the measuring tube and pull it out again.

The oil level must be between the two marks on the dip stick.

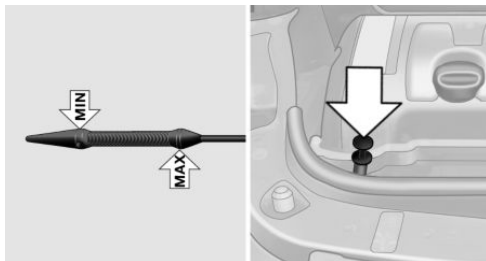

The oil quantity between the two marks on the dip stick equals approx. 1 US quart/1 liter.

Do not exceed the high mark of the dip stick.

Adding engine oil

Filler neck

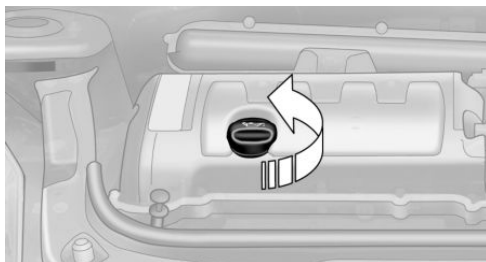

Add a maximum quantity of 1 US quart/1 liter of oil only after the corresponding message appears on the Control Display or, in diesel engines, after the oil level is just above the low mark of the dip stick, refer to page 232.



CAUTION

A too low engine oil level causes engine damage. There is risk of property damage.

Add engine oil within the next 30 miles/50 km. ◀

**CAUTION**

Too much engine oil can damage the engine or the catalytic converter. There is risk of property damage. Do not add too much engine oil. Have excess engine oil suctioned off by a dealer's service center or another qualified service center or repair shop. ◀

**WARNING**

Operating materials, e.g. oils, greases, coolants, fuels, can contain harmful ingredients. There is risk of injuries or danger to life. Observe the instructions on the containers. Avoid the contact of articles of clothing, skin or eyes with operating materials. Do not refill operating materials into different bottles. Store operating materials out of reach of children. ◀

Engine oil types to add**Information****CAUTION**

Oil additives can damage the engine. There is risk of property damage. Do not use oil additives. ◀

**CAUTION**

Incorrect engine oil can cause malfunctions in the engine or damage it. There is risk of property damage. When selecting an engine oil, make sure that the engine oil has the correct viscosity grade. ◀

The engine oil quality is critical for the life of the engine.

Viscosity grades

When selecting an engine oil, ensure that the engine oil belongs to one of the viscosity grades SAE 0W-40, SAE 0W-30, SAE 5W-40, and SAE 5W-30.

Suitable engine oil types

Add engine oils that meet the following oil rating standards:

Gasoline engine

BMW Longlife-01

BMW Longlife-01 FE

Further information regarding suitable engine oil ratings and viscosities can be obtained from a dealer's service center or another qualified service center or repair shop.

Alternative engine oil types

If an engine oil suitable for continuous use is not available, up to 1 US quart/liter of an engine oil with the following oil rating can be added:

Gasoline engine

API SL or superior oil rating

Engine oil change

The vehicle manufacturer recommends that you let the dealer's service center or another qualified service center or repair shop change the engine oil.

**MINI recommends
MINI Original Engine Oil.**

COOLANT

VEHICLE FEATURES AND OPTIONS

This chapter describes all standard, country-specific and optional features offered with the series. It also describes features that are not necessarily available in your car, e. g., due to the selected options or country versions. This also applies to safety-related functions and systems.

When using the features and systems described here, adhere to local regulations.

GENERAL INFORMATION

WARNING

With the engine hot and the cooling system open, coolant can escape and lead to burns. There is risk of injuries. Only open the cooling system with the engine cooled down. ◀

WARNING

Additives are harmful and incorrect additives can damage the engine. There is risk of injuries and risk of property damage. Avoid the contact of articles of clothing, skin or eyes with additives. Do not swallow any additives. Use suitable additives only. ◀

Coolant consists of water and additives.

Not all commercially available additives are suitable for the vehicle. Information regarding suitable additives is available from a dealer's service center or another qualified service center or repair shop.

COOLANT TEMPERATURE

If the coolant and therefore the engine overheats, a warning lamp lights up. A message appears on the Control Display.

COOLANT LEVEL

Checking

1. Do not open the hood until the engine has cooled down.
2. Turn the expansion tank cap counterclockwise slightly to allow any accumulated pressure to escape; then continue turning to open.
3. The coolant level is correct if it is between the markings. The markings are located on the side of the coolant reservoir.

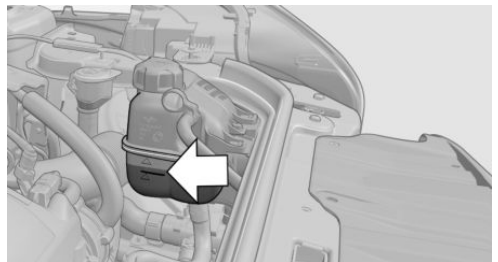

Refilling

1. Do not open the hood until the engine has cooled down.
2. Turn the expansion tank cap counterclockwise slightly to allow any accumulated pressure to escape, then continue turning to open.
3. If the coolant level is low, slowly add coolant up to the specified level; do not overfill.

4. Twist the cap closed.
5. Have the cause of the coolant loss eliminated as soon as possible.

Disposal



Comply with the appropriate environmental protection regulations when disposing of coolant additives.

MAINTENANCE

VEHICLE FEATURES AND OPTIONS

This chapter describes all standard, country-specific and optional features offered with the series. It also describes features that are not necessarily available in your car, e. g., due to the selected options or country versions. This also applies to safety-related functions and systems.

When using the features and systems described here, adhere to local regulations.

MINI MAINTENANCE SYSTEM

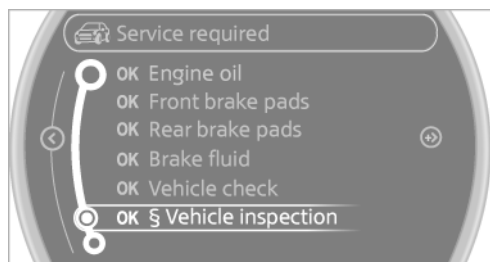

The MINI maintenance system provides information on required maintenance measures and thus provides support in maintaining road safety and the operational reliability of the vehicle.

CONDITION BASED SERVICE CBS

Sensors and special algorithms take into account the various driving conditions of your MINI. Based on this, Condition Based Service determines the current and future maintenance requirements.

The system makes it possible to adapt the amount of maintenance you need to your user profile.

Detailed information on service requirements can be displayed on the Control Display, refer to page 74.

Service data in the remote control

Information on the required maintenance is continuously stored in the remote control. The dealer's service center can read this data out and suggest an optimized maintenance scope for your vehicle.

Therefore, hand the service advisor the remote control with which the vehicle was driven most recently.

Make sure the date is set correctly; otherwise, the effectiveness of CBS Condition Based Service is not ensured.

Storage periods

Storage periods during which the vehicle battery was disconnected are not taken into account.

If this occurs, have a dealer's service center or another qualified service center or repair shop update the time-dependent maintenance procedures, such as checking brake fluid and, if necessary, changing the engine oil and the microfilter/activated-charcoal filter.

SERVICE AND WARRANTY INFORMATION BOOKLET FOR US MODELS AND WARRANTY AND SERVICE GUIDE BOOKLET FOR CANADIAN MODELS

Please consult your Service and Warranty Information Booklet for US models and Warranty

and Service Guide Booklet for Canadian models for additional information on service requirements.

The manufacturer of your vehicle recommends that maintenance and repair be performed by a dealer's service center or another qualified service center or repair shop. Records of regular maintenance and repair work should be retained.

SOCKET FOR OBD ONBOARD DIAGNOSIS



CAUTION

The socket for Onboard Diagnosis is an intricate component intended to be used in conjunction with specialized equipment to check the vehicle's primary emissions system. Improper use of the socket for Onboard Diagnosis, or contact with the socket for Onboard Diagnosis for other than its intended purpose, can cause vehicle malfunctions and creates risks of personal and property damage. Given the foregoing, the manufacture of your vehicle strongly recommends that access to the socket for Onboard Diagnosis be limited to a dealer's service center or another qualified service center or repair shop or other persons that have the specialized training and equipment for purposes of properly utilizing the socket for Onboard Diagnosis. ◀

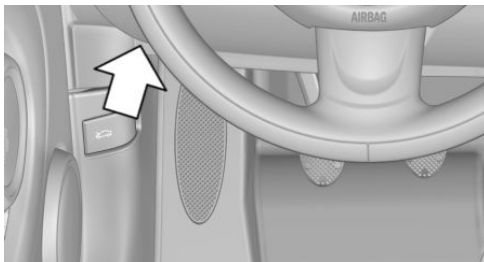

Primary components in the vehicle emissions can be checked via the OBD socket using a device.

Emissions



The warning lamps light up. The vehicle is producing higher emissions. Further driving at a moderate pace is possible.

Have the vehicle checked as soon as possible.

Under certain circumstances, one of the lamps flashes or lights up continuously. This indicates that there is excessive misfiring or a malfunction in the engine. In this situation, decrease the vehicle speed and immediately drive to a dealer's service center or another qualified service center or repair shop. Serious engine misfiring within a brief period can seriously damage emission control components, in particular the catalytic converter. In addition, the mechanical engine components may become damaged.



If the fuel filler cap is not properly tightened, the OBD system may conclude that fuel vapor is escaping; this will cause a display to light up. If the filler cap is then tightened, the display should go out in a few days.

REPLACING COMPONENTS

VEHICLE FEATURES AND OPTIONS

This chapter describes all standard, country-specific and optional features offered with the series. It also describes features that are not necessarily available in your car, e. g., due to the selected options or country versions. This also applies to safety-related functions and systems.

When using the features and systems described here, adhere to local regulations.

WIPER BLADE REPLACEMENT

General information



CAUTION

If the wiper arm falls onto the windshield without the wiper blades installed, the windshield can be damaged. There is risk of property damage. Secure the wiper arm when replacing the wiper blades and do not fold down the wipers without the wiper blades installed. ◀

Replacing the front wiper blades

1. Fold and hold the wiper arm.
2. Squeeze the locking spring, arrows 1, and fold out the wiper blade, arrow 2.



3. Take the wiper blade out of the catch mechanism toward the front.
4. Press the new wiper blade into the fixation until it engages audibly.
5. Fold down the wiper arm.



CAUTION

Folded-away wipers can be jammed when the hood is opened. There is risk of property damage. Make sure that the wipers with the wiper blades mounted are folded down onto the windshield before opening the hood. ◀

Changing the rear wiper blade

MINI Countryman:



MINI Paceman:



1. Fold up and hold the wiper arm.
2. Turn the wiper blade all the way back, arrow.

3. Press the wiper blade against the stop to push it out of the fixation.
4. Press the new wiper blade into the fixation until it engages audibly.
5. Fold down the wiper arm.

LAMP AND BULB REPLACEMENT

Information

Lamps and bulbs

Lamps and bulbs make an essential contribution to vehicle safety. Therefore, exercise caution when handling lights and bulbs.

The vehicle manufacturer recommends that you have the necessary work performed by a dealer's service center or another qualified service center or repair shop if you are unfamiliar with it or it is not described here.

A spare lamp box is available from a dealer's service center or another qualified service center or repair shop.

WARNING

Bulbs can get hot during operation. Contact with the bulbs can cause burns. There is risk of injuries. Only change bulbs after they have cooled off. ◀

WARNING

Work on switched-on lighting systems can cause short circuits. There is risk of injuries or risk of property damage. When working on the lighting system, switch off the lamps in question. If necessary, heed the bulb manufacturer's instructions. ◀

CAUTION

Contaminated bulbs reduce their service life. There is risk of property damage. Do not hold new bulbs with your bare hands. Use a

clean cloth or something similar, or hold the bulb by its base. ◀

Caring for the headlights, refer to page 255.

For bulb replacement procedures that are not described here, contact a dealer's service center or another qualified service center or repair shop.

For checking and adjusting headlamp aim, contact a dealer's service center or another qualified service center or repair shop.

Light-emitting diodes LEDs

In some equipment, the light source is provided by light-emitting diodes behind a cover.

These light-emitting diodes, which operate using a concept similar to that applied in conventional lasers, are designated as Class 1 light-emitting diodes.

WARNING

Too intensive brightness can irritate or damage the retina of the eye. There is risk of injuries. Do not look directly into the headlights or other light sources for an extended period of time. Do not remove the LED covers. ◀

Headlight glass

Condensation can form on the inside of the external lights in cool or humid weather. When you drive with the lights switched on, the condensation evaporates after a short time. The headlight glass does not need to be changed.

If despite driving with the lights switched on, increasing humidity forms, e. g. water droplets in the lamp, the manufacturer of your vehicle recommends having it checked by a dealer's service center or another qualified service center or repair shop.

Bi-xenon headlights

These bulbs have a very long life and the likelihood of failure is very low, provided that they are not switched on and off excessively. If a bulb should nevertheless fail, you can continue

driving cautiously with the front fog lights, provided this is permitted by local laws.

DANGER

There can be high voltage in the lighting system. There is danger to life. The manufacturer of your vehicle recommends that the work on the lighting system including bulb replacement be performed by a dealer's service center or another qualified service center or repair shop. ◀

Front lights, bulb replacement

Overview

Headlights



- 1 Low beams/high-beams
- 2 Turn signal

Lower front lights

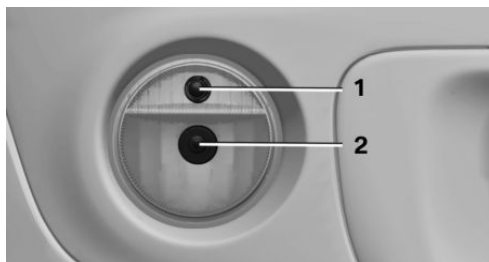

- 1 Parking lights
- 2 Daytime running lights or fog lights

Lower LED front lights

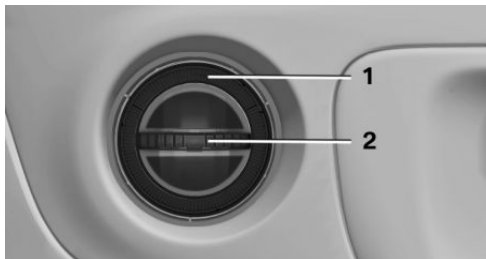

- 1 Parking lights / daytime running lights
- 2 Fog lights

Halogen low beams and high-beams

H13 bulb, 60/55 watt

Access to the bulbs through the engine compartment

Follow the general instructions on lamps and bulbs, refer to page 239.

Low beam/high-beam bulbs can be changed from the engine compartment.

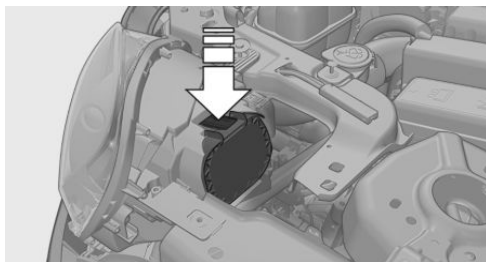

To remove the cover:

1. Press the tab.
2. Fold away the cover and take it out of the holder.

Proceed in reverse order to attach the cover.

Replacing the bulb

1. Turn the bulb counterclockwise, arrow 1, and remove it, arrow 2.

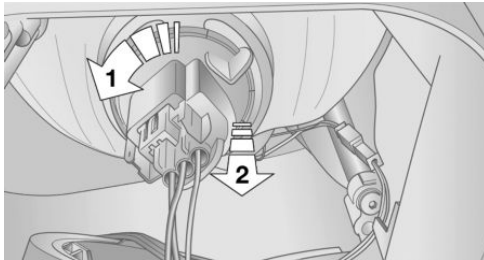

2. Press the release, arrow 1, and pull off the connector, arrow 2.

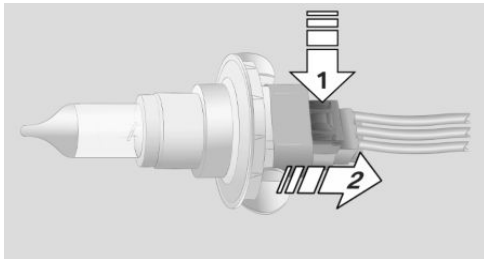

3. Insert the new bulb and attach the cover in reverse order.

LED parking lights/LED fog lights/LED daytime running lights

Follow the general instructions on lamps and bulbs, refer to page 239.

Lights are implemented using LED technology. In case of a malfunction, contact a dealer's service center or another qualified service center or repair shop.

Turn signals/parking lights/roadside parking lights/fog lights/and daytime running lights

Access to the bulbs via the wheel housing

Follow the general instructions on lamps and bulbs, refer to page 239.

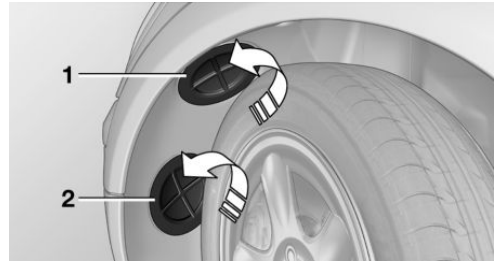

- 1 Turn signal
- 2 Parking lights/roadside parking lights/fog lights/and daytime running lights

Replacing the turn signal bulb

21-watt bulb, P 21 W, or PY 21 W

1. Turn the wheel.
2. Remove cover 1.
To do this, turn the cover counterclockwise.
3. Remove the inside cover. To do this, turn the cover counterclockwise.



4. Turn the bulb counterclockwise and remove it.

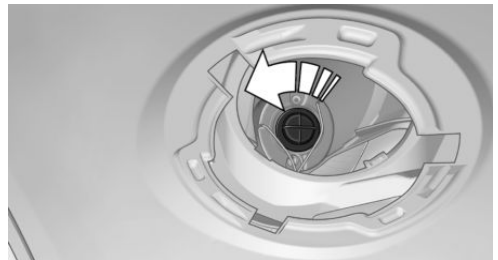

5. Insert the new bulb and attach the covers in reverse order.

Replacing the parking light bulb and roadside parking light bulb

5-watt bulb, W 5 W

1. Turn the wheel.
2. Remove cover 2.
To do this, turn the cover counterclockwise.
3. Turn the upper bulb counterclockwise and remove it.

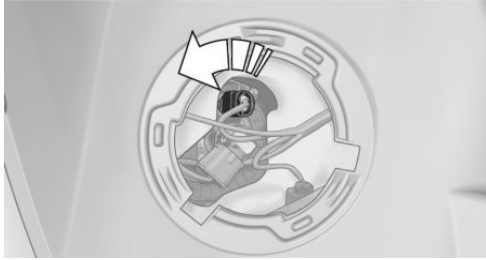

4. Insert the new bulb and attach the cover in reverse order.

Replacing the front fog light bulb

H8 bulb, 35 watt

1. Turn the wheel.
2. Remove cover 2.
To do this, turn the cover counterclockwise.
3. Pull off the plug-in cable connector.
4. Turn the lower bulb counterclockwise and remove it.



5. Insert the new bulb and attach the cover in reverse order.

Replacing the daytime running light bulb

Bulb PSX24W

1. Turn the wheel.
2. Remove cover 2.
To do this, turn the cover counterclockwise.
3. Pull off the plug-in cable connector.
4. Squeeze the lower bulb at both tabs and pull out.

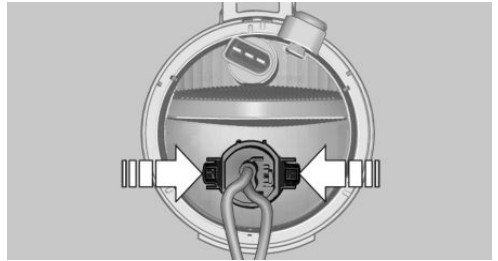

5. Insert the new bulb and attach the cover in reverse order.

Lateral turn signals

5-watt bulb, W 5 W

1. Open the hood.

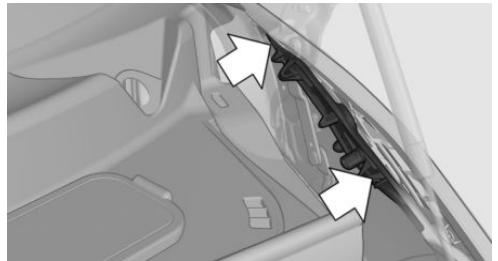

2. Squeeze the clip, arrows, and remove the bulb holder.
3. Remove the bulb by turning it to the left and replace it.
4. Insert the new bulb and attach the cover in reverse order.

Side marker lights

To replace these bulbs, contact a dealer's service center or another qualified service center or repair shop.

Tail lights, bulb replacement

Follow the general instructions on lamps and bulbs, refer to page 239.

Turn signal: 21-watt bulb, PY 21 W

MINI Countryman

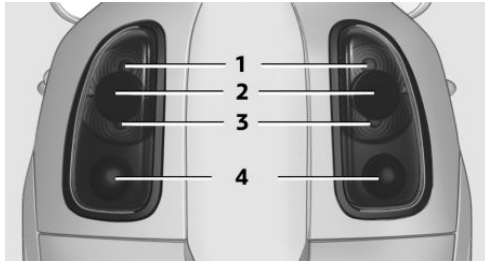

- 1 Brake/tail light
- 2 Turn signal
- 3 Brake/tail light
- 4 Backup light

MINI Paceman

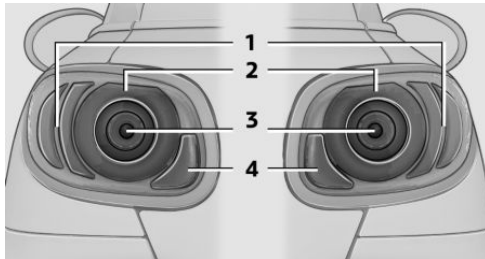

- 1 Brake light
- 2 Tail light
- 3 Turn signal
- 4 Backup light

Replacing

All bulbs are integrated in a central bulb holder.

MINI Countryman

1. Switch off the lights and take the remote control out of the ignition lock.
2. Open the tailgate.
3. Press the cover out of the cargo area side panel at the rear and remove it.



4. Detach the emergency release of the fuel filler flap, refer to page 214, and push it aside with the foam insert. Ensure that the emergency release is not damaged.
5. Disengage the bulb holder by pushing down the clip, arrow 1.

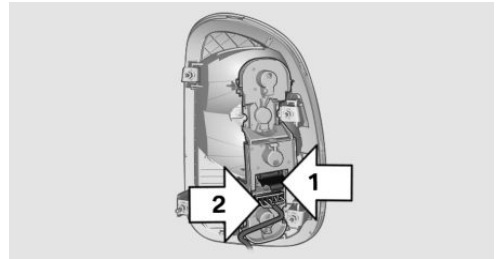

6. Take out the bulb holder and detach the cable, arrow 2.
7. Apply gentle pressure to the bulb while turning it to the left and remove it.
8. Insert the new bulb and mount the bulb holder in reverse order. Ensure that the bulb holder engages in all fasteners.

9. Return the foam insert to its original position and reattach the emergency release of the fuel filler flap.
10. Reattach the cover.

MINI Paceman

1. Switch off the lights and take the remote control out of the ignition lock.
2. Open the tailgate.
3. Remove the cover from the cargo area side trim.

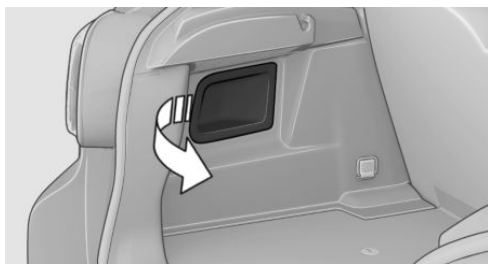

4. Unlock the fastening elements, arrows 1, by turning.

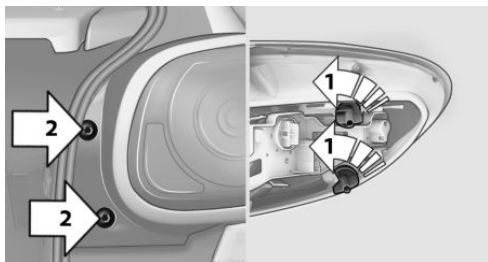

5. Remove the screws, arrows 2, using the hex key from the vehicle document portfolio.
6. Remove the tail light.

7. Disengage the bulb holder by pushing down the clip, arrows 1.

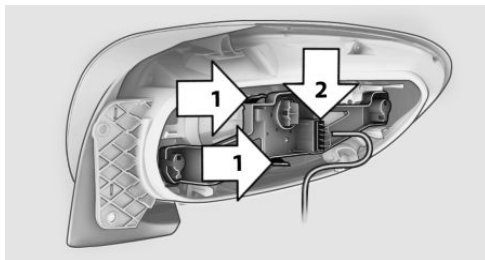

8. Take out the bulb holder and detach the cable, arrow 2.
9. Apply gentle pressure to the bulb while turning it to the left and remove it.
10. Insert the new bulb and mount the bulb holder in reverse order. Ensure that the bulb holder engages in all fasteners.

License plate lights

5-watt bulb, C 5 W

Replacing

MINI Countryman

1. Push the light to the left in the catch of the light housing using the screwdriver, arrow 1.

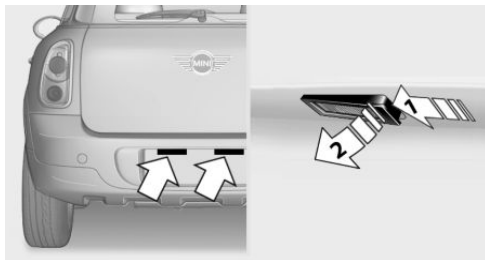

2. Take out the light, arrow 2.
3. Replace the bulb.
4. Insert the light.

MINI Paceman

1. Push the light to the left in the catch of the light housing using the screwdriver, arrow 1.

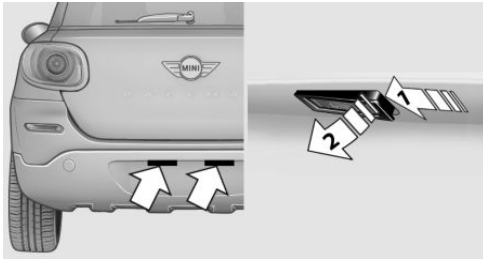

2. Take out the light, arrow 2.
3. Replace the bulb.
4. Insert the light.

Center brake light

This light uses LED technology for operation. In case of a malfunction, contact a dealer's service center or another qualified service center or repair shop.

CHANGING WHEELS

Information

The vehicle may be equipped with conventional tires with the Mobility System, refer to page 226, or with run-flat tires, refer to page 226.

No spare tire is available in the case of a flat tire.

The suitable tools for changing wheels are available as accessories from a dealer's service center or another qualified service center or repair shop.

Safety measures

- ▷ Park the vehicle as far as possible from passing traffic and on solid ground. Switch on the hazard warning system.

- ▷ Set the parking brake and move the selector lever to position P.
- ▷ Have all vehicle occupants get out of the vehicle and ensure that they remain outside the immediate area in a safe place, such as behind a guardrail.
- ▷ If a warning triangle or portable hazard warning lamp is required, set it up on the roadside at an appropriate distance from the rear of the vehicle.
- ▷ Change the wheel only on a level, firm surface which is not slippery. The vehicle or the jack could slip to the side if you attempt to raise the vehicle on a soft or slippery surface such as snow, ice, tiles, etc.
- ▷ Do not use a wooden block or similar object as a support base for the jack, as this would prevent it from extending to its full support height and reduce its load-carrying capacity.
- ▷ To avoid serious or fatal injury: never lie under the vehicle, and never start the engine while it is supported by the jack.

Jacking points for the vehicle jack

MINI Countryman:

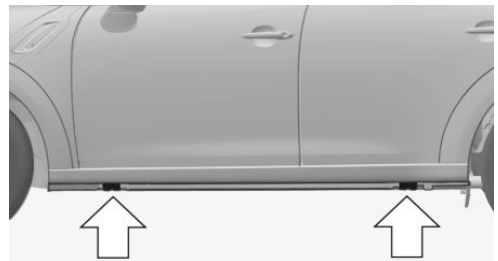

MINI Paceman:

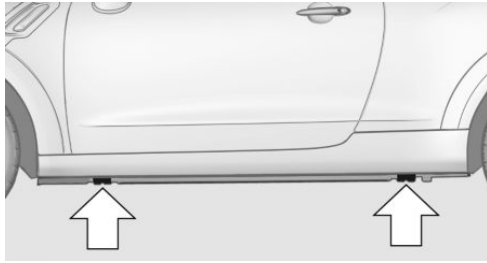

The jacking points for the vehicle jack are located in the positions shown.

VEHICLE BATTERY

Maintenance

The battery is maintenance-free, i.e., the electrolyte will last for the life of the battery in temperate climate conditions.

A dealer's service center will be glad to answer any questions you may have.

Battery replacement



CAUTION

Vehicle batteries that are not compatible can damage vehicle systems and impair vehicle functions. There is a risk of personal and property damage. Only vehicle batteries that are compatible with your vehicle type should be installed in your vehicle. Information on compatible vehicle batteries is available at your dealer's service center. ◀

After a battery replacement, the manufacturer of your vehicle recommends that the vehicle battery be registered on the vehicle by a dealer's service center or another qualified service center or repair shop to ensure that all comfort features are fully available and that any Check Control messages of these comfort features are no longer displayed.

Charging the battery

Information



CAUTION

Battery chargers for the vehicle battery can work with high voltages and currents, which means that the 12V on-board network can be overloaded or damaged. There is risk of property damage. Only connect battery chargers for the vehicle battery to the starting aid terminals in the engine compartment. ◀

Only charge the battery in the vehicle when the engine is switched off. Connections, refer to page 248.

General information

Ensure that the battery is sufficiently charged to achieve the full battery life.

It may be necessary to charge the battery in the following cases:

- ▷ When the vehicle is frequently used to travel short distances.
- ▷ When the vehicle has not been driven for more than one month.

Power failure

After a temporary power failure, some equipment will be restricted in its use and will need to be reinitialized. In addition, certain individual settings will be lost and must be updated:

- ▷ Time and date: the values must be updated, refer to page 72.
- ▷ Radio: the stations need to be stored again, refer to page 157.
- ▷ Onboard monitor: full functionality will be restored after some time.
- ▷ Glass sunroof, electrical: it may only be possible to tilt the roof. The system needs to be initialized. Contact a dealer's service center or another qualified service center or repair shop.

Indicator/warning lights



Lights up red: the vehicle battery is no longer being charged. Alternator malfunction.

Switch off all unnecessary electrical consumers. Have the battery checked immediately.



Lights up yellow: the battery charge level is very low, the battery is old, or it is not securely connected.

Charge the battery by taking a long drive or using an external charger. If the indicators appear again, have the battery checked as soon as possible.

Disposing of old batteries



After they are replaced, have old batteries disposed of by a dealer's service center or another qualified service center or repair shop or take them to a collection point.

Maintain the battery in an upright position for transport and storage. Secure the battery so that it does not tip over during transport.

FUSES



WARNING

Incorrect and repaired fuses can overload electrical lines and components. There is risk of fire. Never attempt to repair a blown fuse and do not replace a nonworking fuse with a substitute of another color or amperage rating. ◀

Have the fuses replaced by a dealer's service center or another qualified service center or repair shop.

Information on the fuses can be found on the inside of the covers.

In the engine compartment

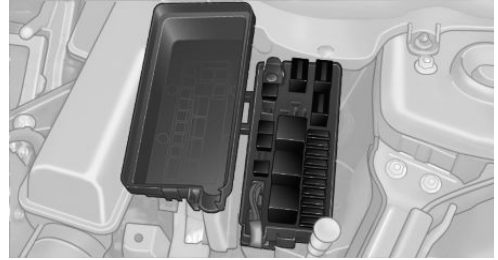

Opening the cover

Press the snap lock.

In interior

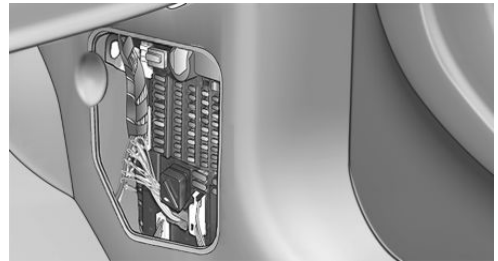

On the right side of the footwell.

Opening the cover

Push out at the recess.

BREAKDOWN ASSISTANCE

VEHICLE FEATURES AND OPTIONS

This chapter describes all standard, country-specific and optional features offered with the series. It also describes features that are not necessarily available in your car, e. g., due to the selected options or country versions. This also applies to safety-related functions and systems.

When using the features and systems described here, adhere to local regulations.

HAZARD WARNING FLASHERS



The button is located on the speedometer.

WARNING TRIANGLE

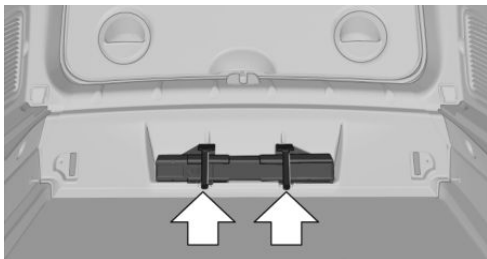

Under the loading edge in the cargo area.

To remove, open the two fasteners.

FIRST AID KIT

Some of the articles contained in the first aid kit have a limited service life. Therefore, check the use-by dates of the contents regularly and replace the items before they expire.

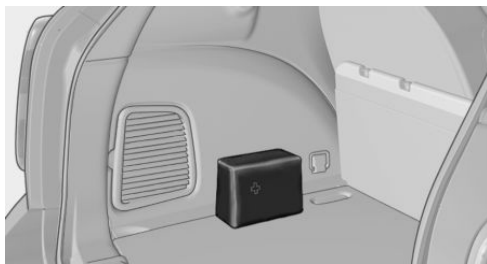

The first aid kit is located in the left side trim on the cargo area floor or under the loading floor.

ROADSIDE ASSISTANCE

Service availability

Roadside Assistance can be reached around the clock in many countries. You can obtain assistance there in the event of a vehicle breakdown.

JUMP-STARTING

Information

If the battery is discharged, the engine can be started using the battery of another vehicle and two jumper cables. In the same way, you can help jump-start another vehicle. Only use jumper cables with fully insulated clamp handles.

To prevent personal injury or damage to both vehicles, adhere strictly to the following procedure.

DANGER

Contact with live components can lead to an electric shock. There is risk of injuries or danger to life. Do not touch any components that are under voltage. ◀

Preparation

1. Check whether the battery of the other vehicle has a voltage of 12 volts and approximately the same capacitance in Ah. This information can be found on the battery.
2. Switch off the engine of the assisting vehicle.
3. Switch off any electronic systems/power consumers in both vehicles.

CAUTION

In the case of body contact between the two vehicles, a short circuit can occur during jump-starting. There is risk of property damage. Make sure that no body contact occurs. ◀

Connecting jumper cables

WARNING

If the jumper cables are connected in the incorrect order, sparks formation can occur. There is risk of injuries. Pay attention to the correct order during connection. ◀

1. Open the battery cover in the engine compartment to access the positive terminal.

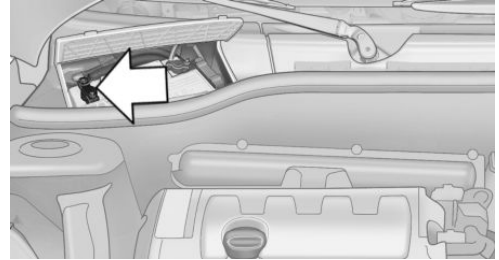

2. Unlock the tabs of the positive terminal cover on the left and right, arrows 1, and raise the cover, arrow 2.

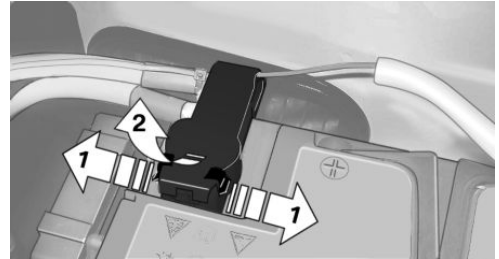

3. Attach one terminal clamp of the positive jumper cable to the positive terminal of the battery or to a starting aid terminal of the vehicle providing assistance.
4. Attach the second clamp of the positive jumper cable to the positive terminal of the battery of the vehicle to be started.
5. Attach one terminal clamp of the negative jumper cable to the negative terminal of the battery, or to the corresponding engine

or body ground of the vehicle providing assistance.

6. Attach the second clamp of the negative jumper cable to the negative terminal of the battery, or to the engine or body ground of the vehicle to be started.

Body ground:

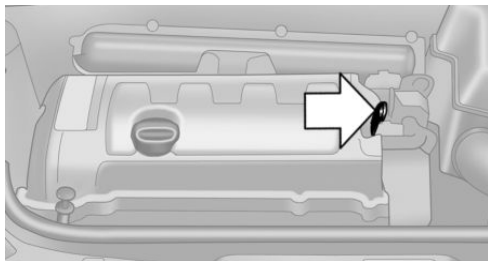

Starting the engine

Never use spray fluids to start the engine.

1. Start the engine of the assisting vehicle and let it run for several minutes at a slightly increased idle speed.
2. Start the engine of the vehicle being started in the usual way.

If the first starting attempt is not successful, wait a few minutes before making another attempt in order to allow the discharged battery to recharge.

3. Let both engines run for several minutes.
4. Disconnect the jumper cables in the reverse order.

Check the battery and recharge if necessary.

TOW-STARTING AND TOWING

Information



Warning

There is an increased danger of accidents when towing vehicles. There is a risk of personal injury. Do not transport any passengers

other than the driver in a vehicle that is being towed. ◀

Using a tow fitting

The screw-in tow fitting must always be carried in the vehicle. It can be screwed in at the front or rear of the MINI.

The tow fitting is stowed in the following location, depending on the equipment:

- ▷ Under the right or left front seat.
- ▷ In the pouch of the wheel change set in the cargo area.



CAUTION

If the tow fitting is not used as intended, there can be damage to the vehicle or to the tow fitting. There is risk of property damage. Observe the notes on using the tow fitting. ◀

Use of the tow fitting:

- ▷ Use only the tow fitting provided with the vehicle and screw it all the way in.
- ▷ Use the tow fitting for towing on paved roads only.
- ▷ Avoid lateral loading of the tow fitting, e.g., do not lift the vehicle by the tow fitting.

Access to the screw thread

Push out the tow fitting cover at the appropriate recess in the bumper.

Front

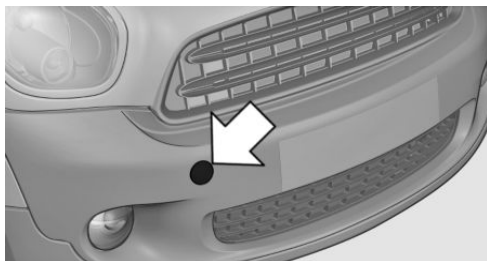

Rear



Being towed

Adhere to the following information:

- ▷ Make sure that the ignition is switched on; otherwise, the low beams, tail lights, turn signals, and windshield wipers may be unavailable.
- ▷ Do not tow the vehicle with the rear axle tilted, as the front wheels could turn.
- ▷ When the engine is stopped, there is no power assist. Consequently, more force needs to be applied when braking and steering.
- ▷ Larger steering wheel movements are required.
- ▷ Switch on the hazard warning system, depending on local regulations.

Manual transmission

Gearshift lever in neutral position.

Steptronic transmission

 **CAUTION**
The vehicle can be damaged when towing the vehicle with a lifted rear axle. There is risk of property damage. Have vehicle transported only with lifted front axle or on a loading platform. ◀

Towing with a tow bar

 **WARNING**
If the approved gross vehicle weight of the towing vehicle is lighter than the vehicle to be towed, the tow fitting can tear off or it will not be possible to control the vehicle's response. There is risk of an accident! Make sure that the gross vehicle weight of the towing vehicle is heavier than the vehicle to be towed. ◀

 **CAUTION**
If the tow bar or tow rope is attached incorrectly, damage to other vehicle parts can occur. There is risk of property damage. Correctly attach the tow bar or tow rope to the tow fitting. ◀

The tow fittings used should be on the same side on both vehicles.

Should it prove impossible to avoid mounting the tow bar at an offset angle, please observe the following:

- ▷ Clearance and maneuvering capability will be sharply limited during cornering.
- ▷ The tow bar will generate lateral forces if it is attached offset.

Towing with a tow rope

When starting to tow the vehicle, make sure that the tow rope is taut.

To avoid jerking and the associated stresses on the vehicle components when towing, always use nylon ropes or nylon straps.

 **CAUTION**
If the tow bar or tow rope is attached incorrectly, damage to other vehicle parts can occur. There is risk of property damage. Correctly attach the tow bar or tow rope to the tow fitting. ◀

With a tow truck: vehicles without ALL4 all-wheel drive



CAUTION

When lifting the vehicle by the tow fitting or body and chassis parts; damage can occur on vehicle parts. There is risk of property damage. Lift vehicle using suitable means. ◀

MINI Countryman:

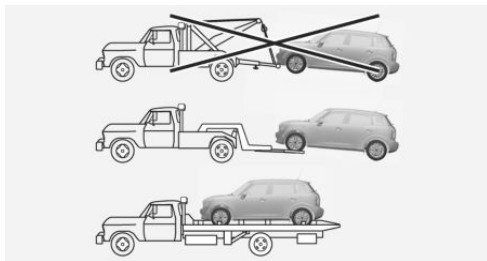

MINI Paceman:

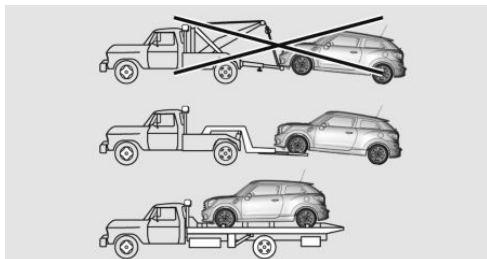

Have the vehicle transported with a tow truck with a so-called lift bar or on a flat bed.

With a tow truck: vehicle with ALL4 all-wheel drive



CAUTION

When lifting the vehicle by the tow fitting or body and chassis parts; damage can occur on vehicle parts. There is risk of property damage. Lift vehicle using suitable means. ◀



CAUTION

The vehicle can be damaged when towing the vehicle with a single lifted axle. There is risk of property damage. Only transport the vehicle on a flat-bed. ◀

MINI Countryman:

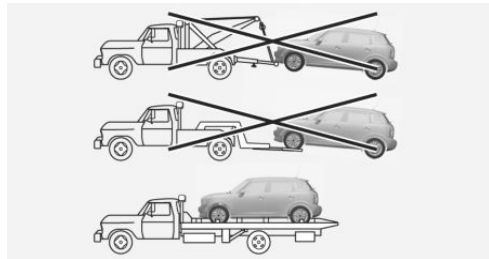

MINI Paceman:

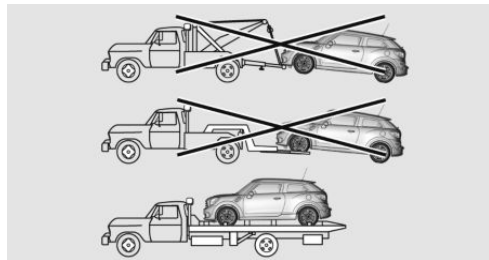

Only transport the vehicle on a flat-bed.

Tow-starting

If possible, start the engine by jump-starting, refer to page 248, it rather than tow-starting the vehicle. Vehicles with a catalytic converter should only be tow-started when the engine is cold; vehicles with an automatic transmission cannot be tow-started.

1. Switch on the hazard warning system and comply with local regulations.
2. Switch on the ignition, refer to page 58.
3. Engage third gear.
4. Have the vehicle tow-started with the clutch is depressed and then slowly release

the clutch. After the engine starts, immediately depress the clutch completely again.

5. Stop at a suitable location, remove the tow bar or rope, and switch off the hazard warning system.
6. Have the vehicle checked.

CARE

VEHICLE FEATURES AND OPTIONS

This chapter describes all standard, country-specific and optional features offered with the series. It also describes features that are not necessarily available in your car, e. g., due to the selected options or country versions. This also applies to safety-related functions and systems.

When using the features and systems described here, adhere to local regulations.

CAR WASHES

General information

Wash your vehicle frequently, particularly in winter. Intense soiling and road salt can damage the vehicle.

Information

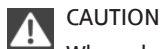

CAUTION When cleaning with high-pressure washers, components can be damaged due to the pressure or temperatures being too high. There is risk of property damage. Maintain sufficient distance and do not spray too long continuously. Follow the operating instructions for the high-pressure washer. ◀

Do not direct steam or high-pressure washers toward the labels applied by the manufacturer; otherwise, damage may result.

Distances and temperature

- ▷ Maximum temperature: 140 °F/60 °C.
- ▷ Minimum distance from sensors, cameras, seals: 12 inches/30 cm.

After washing the vehicle, apply the brakes briefly to dry them; otherwise, braking action can be reduced and corrosion of the brake discs can occur.

Regularly remove foreign bodies, such as leaves, from the area of the windshield when the hood is open.

Washing in automatic car washes

Give preference to cloth car washes or those that use soft brushes in order to avoid paint damage.

Do not use automatic high-pressure washers; otherwise, water may drip into the interior in the area of the windows.

Before driving into the car wash, check whether the system is suitable for your MINI. Note the following points:

- ▷ Vehicle dimensions, refer to page 260.
- ▷ If necessary: fold in the exterior mirrors, refer to page 50.
- ▷ Maximum permissible tire width.



CAUTION Too high guide rails in car washes can damage body parts. There is risk of property damage. Avoid car washes with guide rails higher than 4 in/10 cm. ◀

Preparations before driving into the car wash:

- ▷ Unscrew the road antenna.
- ▷ Deactivate the rain sensor to avoid unintentional wiper activation.
- ▷ Deactivate the rear window wiper and protect it from damage. Ask the car wash operator about any suitable protective measures.
- ▷ Remove additional attachments, for instance a spoiler or telephone antenna, if there is a risk that these may be damaged.

- ▶ Insert the remote control into the ignition lock.

Steptronic transmission

Before driving into the car wash, note the following to ensure that the vehicle can roll:

1. Insert the remote control into the ignition lock, even with Comfort Access.
2. Move the selector lever to position N.
3. Release the parking brake.
4. Switch the engine off.
5. Leave the remote control in the ignition lock so that the vehicle can roll.

Hand car wash

If washing the vehicle by hand, use copious quantities of water and car shampoo if necessary. Clean the vehicle with a sponge or a washing brush by applying gentle pressure.

Before cleaning the windshield, deactivate the rain sensor to avoid unintentional wiper activation or switch off the ignition.



Adhere to the local regulations regarding washing cars by hand.

Headlights

Do not rub dry and do not use abrasive or caustic cleansers. Soak areas that have been soiled, e.g., due to insects, with shampoo and rinse off with copious quantities of water.

Thaw ice with a window deicer; do not use an ice scraper.

Windows

Clean the outside and inside surfaces of the windows and the mirror glasses with window cleaner.

Do not clean mirror glass with cleaners containing quartz.

Wiper blades

Clean with soapy water and replace regularly to avoid streaking.

Wax and preservative residue and soiling on the windows cause streaking during window wiping and lead to premature wear on the wiper blades and malfunctions of the rain sensor.

VEHICLE CARE

Car care products

Regular cleaning and care contributes significantly to vehicle value retention.

The manufacturer of your vehicle recommends using car care and cleaning products from MINI.



WARNING

Cleansers can contain substances that are dangerous and harmful to your health. There is risk of injuries. When cleaning the interior, open the doors or windows. Only use products intended for cleaning vehicles. Follow the instructions on the container. ◀

Vehicle paint

Regular care contributes to vehicle value retention and protects the paintwork against the long-term effects of paint-damaging substances.

Environmental influences in areas with higher air pollution or natural contaminants, such as tree resin or pollen, can have an impact on the vehicle paint. Therefore, it is important to tailor the frequency and extent of your car care to these influences.

Immediately remove especially aggressive substances, such as spilled fuel, oil, grease, or bird droppings, to prevent damage to the paintwork.

Correcting paint damage

Depending on the severity of the damage, repair stone impact damage or scratches immediately to prevent rust formation.

The manufacturer recommends having paint damage corrected with a professional repair paint job according to factory specifications using original MINI paint materials.

Preservation

Preservation is needed when water no longer beads off of the clean paint surfaces. Only use paint preservation products that contain carnauba or synthetic waxes.

Caring for matte finishes

Only use cleaning and care products suitable for vehicles with matte finish. These are available from a dealer's service center or another qualified service center or repair shop.

Leather care

The leather processed by the manufacturer is a high quality natural product. Light graininess is a typical feature of natural leather.

Particles of dust and road grime chafe in pores and folds, and lead to increased wear and premature degradation of the leather surface. Therefore, remove dust from the leather regularly, using a cloth or vacuum cleaner.

Make especially sure that light-colored leather is cleaned regularly as it is more susceptible to soiling.

Twice a year, treat the leather with a leather lotion as dirt and grease will attack the protective layer of the leather.

Upholstery material care

Vacuum regularly with a vacuum cleaner to remove superficial soiling.

In case of heavy soiling, e.g., beverage stains, use a soft sponge or lint-free microfiber cloth in

combination with a suitable interior cleaner. Follow the instructions on the container.

Clean the upholstery material down to the seams using large sweeping motions. Avoid rubbing the material vigorously.



CAUTION

Open Velcro® fasteners on articles of clothing can damage the seat covers. There is risk of property damage. Ensure that any Velcro® fasteners are closed. ◀

Caring for special components

Interior plastic parts

These include:

- ▷ Imitation leather surfaces
- ▷ Lamp lenses
- ▷ Indicator covers
- ▷ Matte components

Clean with water and a solvent-free plastic cleaner if necessary.

Rubber seals

Only treat with water or a rubber care product.

When cleaning rubber seals, do not use silicone sprays or other care products containing silicone; otherwise, noise and damage may result.

Chrome surfaces

Carefully clean components such as the radiator grille or door handles with an ample supply of water, possibly with shampoo added, particularly when they have been exposed to road salt. For additional treatment, use a chrome polish.

Light-alloy wheels

When cleaning the wheels on the vehicle, only use a neutral wheel rim cleaner with a pH value of 5 to 9.

Do not use abrasive cleaners or a steam jet hotter than 140 °F/60 °C; otherwise, damage may result. Adhere to the manufacturer instructions.

Aggressive, acidic, or alkaline cleaners may destroy the protective coating of neighboring components such as the brake disc.

Exterior sensors

The sensors on the outside of the vehicle, such as for Park Distance Control, must be kept clean and free of ice to ensure that they remain fully functional.

Decorative trim

Clean decorative trims and fine wood components with a moist cloth only. Then dry with a soft cloth.

Safety belts

Dirty belt straps impede the reeling action and thus have a negative impact on safety.



WARNING

Chemical cleansers can destroy the safety belt webbing. Missing protective effect of the safety belts. There is risk of injuries or danger to life. Use only a mild soapy solution for cleaning the safety belts. ◀

Carpets/floor mats



WARNING

Objects in the driver's floor area can limit the pedal distance or block a depressed pedal. There is risk of an accident. Stow objects in the vehicle such that they are secured and cannot enter into the driver's floor area. Use floor mats that are suitable for the vehicle and can be safely attached to the floor. Do not use loose floor mats and do not layer several floor mats. Make sure that there is sufficient clearance for the pedals. Ensure that the floor mats are securely fastened again after they were removed, e.g. for cleaning. ◀

Floor mats can be removed for cleaning.

If they are very dirty, clean with a microfiber cloth and water or an interior cleaner. To prevent matting of the carpet, rub back and forth in the direction of travel only.

Displays

To clean the displays, such as the radio or display elements, use an antistatic microfiber cloth.



CAUTION

Chemical cleansers, moisture or fluids of any kind can damage the surface of displays and screens. There is risk of property damage. Clean with a clean, antistatic microfiber cloth. ◀

CD/DVD drives



CAUTION

The use of cleaning CDs may damage parts of the drive. There is risk of property damage. Do not use cleaning CDs. ◀

Long-term vehicle storage

A dealer's service center or another qualified service center or repair shop can advise you on what to consider when storing the vehicle for longer than three months.



FIND ME.

AT A GLANCE

CONTROLS

DRIVING TIPS

NAVIGATION

ENTERTAINMENT

COMMUNICATION

MOBILITY

REFERENCE

TECHNICAL DATA

VEHICLE FEATURES AND OPTIONS

This chapter describes all standard, country-specific and optional features offered with the series. It also describes features that are not

necessarily available in your car, e. g., due to the selected options or country versions. This also applies to safety-related functions and systems.

When using the features and systems described here, adhere to local regulations.

INFORMATION

The technical data and specifications in this Owner's Manual are used as guidance values. The vehicle-specific data can deviate from this, for example, due to the selected special equipment, country version or country-specific measurement method. Detailed values can be

found in the approval documents or on labels on the vehicle, or can be obtained from a dealer's service center or another qualified service center or repair shop.

The information in the vehicle documents always has priority.

DIMENSIONS

The dimensions can vary depending on the model version, equipment or country-specific measurement method.

The specified heights do not take into account attached parts, for example, a roof antenna,

roof racks or spoiler. The heights can deviate, for example, due to the selected special equipment, tires, load and chassis version.

MINI Countryman

MINI Countryman		Cooper	Cooper S	John Cooper Works
Width with mirrors	inches/mm	78.6/1,996	78.6/1,996	78.6/1,996
Width without mirrors	inches/mm	70.4/1,789	70.4/1,789	70.4/1,789
Height	inches/mm	61.7/1,566	61.7/1,566	61.4/1,560
Length	inches/mm	161.7/4,107	162.2/4,119	163.1/4,143
With aerodynamic bumper	inches/mm	-	163.2/4,144	
Wheelbase	inches/mm	102.2/2,595	102.2/2,595	102.2/2,595
Smallest turning circle dia.	ft/m	38.1/11.6	38.1/11.6	38.1/11.6

MINI Paceman

MINI Paceman		Cooper	Cooper S	John Cooper Works
Width with mirrors	inches/mm	78.6/1,996	78.6/1,996	78.6/1,996
Width without mirrors	inches/mm	70.3/1,786	70.3/1,786	70.3/1,786
Height	inches/mm	60.4/1,533	60.4/1,533	60.1/1,527
Length	inches/mm	162.2/4,119	162.4/4,124	162.8/4,134
With aerodynamic bumper	inches/mm	-	162.8/4,134	
Wheelbase	inches/mm	102.2/2,596	102.2/2,596	102.2/2,596
Smallest turning circle dia.	ft/m	38.1/11.6	38.1/11.6	38.1/11.6

WEIGHTS

Never exceed either the approved axle loads or the gross vehicle weight.

MINI Countryman

		Cooper	Cooper S
Approved gross vehicle weight			
Manual transmission	lbs/kg	3,860/1,751	3,990/1,810
Steptronic transmission	lbs/kg	3,925/1,780	4,035/1,830
Load	lbs/kg	830/376	830/376
Approved front axle load			
Manual transmission	lbs/kg	2,060/934	2,145/973
Steptronic transmission	lbs/kg	2,125/964	2,200/998
Approved rear axle load	lbs/kg	1,920/871	1,920/871
Approved roof load capacity	lbs/kg	165/75	165/75
Cargo area capacity	cu ft/liter	17.5-42.2/ 350-1,170	17.5-42.2/ 350-1,170
		Cooper S ALL4	John Cooper Works
Approved gross vehicle weight			
Manual transmission	lbs/kg	4,100/1,860	4,155/1,885

		Cooper S ALL4	John Cooper Works
Steptronic transmission	lbs/kg	4,145/1,880	4,200/1,905
Load	lbs/kg	830/376	830/376
Approved front axle load			
Manual transmission	lbs/kg	2,210/1,002	2,210/1,002
Steptronic transmission	lbs/kg	2,260/1,025	2,260/1,025
Approved rear axle load	lbs/kg	2,015/914	2,070/939
Approved roof load capacity	lbs/kg	165/75	165/75
Cargo area capacity	cu ft/liter	17.5-42.2/ 350-1,170	17.5-42.2/ 350-1,170

MINI Paceman

		Cooper	Cooper S	Cooper S ALL4	John Cooper Works
Approved gross vehicle weight					
Manual transmission	lbs/kg	3,850/1,746	3,960/1,796	4,100/1,860	4,150/1,882
Steptronic transmission	lbs/kg	3,920/1,778	4,010/1,819	4,140/1,878	4,200/1,905
Load	lbs/kg	830/376	830/376	830/376	830/376
Approved front axle load					
Manual transmission	lbs/kg	2,050/930	2,120/962	2,180/989	2,200/998
Steptronic transmission	lbs/kg	2,120/962	2,170/984	2,220/1,007	2,240/1,016
Approved rear axle load	lbs/kg	1,910/866	1,910/866	2,020/916	2,060/934
Approved roof load capacity	lbs/kg	165/75	165/75	165/75	165/75
Cargo area capacity	cu ft/liter	13.9-40.7/ 330-1,080	13.9-40.7/ 330-1,080	13.9-40.7/ 330-1,080	13.9-40.7/ 330-1,080

CAPACITIES

			Notes
Fuel tank, approx.	US gal/liters	12.4/47	Fuel quality, refer to page 216

SHORT COMMANDS FOR VOICE ACTIVATION

VEHICLE FEATURES AND OPTIONS

This chapter describes all standard, country-specific and optional features offered with the series. It also describes features that are not necessarily available in your car, e. g., due to the selected options or country versions. This also applies to safety-related functions and systems.

When using the features and systems described here, adhere to local regulations.

ADJUSTING

Vehicle

Function	Command
Open the main menu.	›Main menu‹
Open the options.	›Options‹
Open the settings.	›Settings‹
Settings on the Control Display.	›Control display‹
Open the time and date.	›Time and date‹
Open the language and units.	›Language and units‹
Open the speed limit.	›Speed‹
Open the light.	›Lighting‹
Open the door lock.	›Door locks‹

GENERAL INFORMATION

Instructions for voice activation system, refer to page 24.

To have the available spoken instructions read out loud: ›Voice commands‹

The following short commands apply to vehicles equipped with a voice activation system. They have no function in vehicles in which only the mobile phone is operated using the voice.

VEHICLE INFORMATION

Computer

Function	Command
Open the computer.	›Onboard info‹
Open the trip computer.	›Trip computer‹

Vehicle

Function	Command
Open the vehicle information.	›Vehicle info‹
Open the vehicle status.	›Vehicle status‹

NAVIGATION

General information

Function	Command
Navigation menu.	›Navigation‹
Open the destination entry.	›Enter address‹
Enter the address.	›Enter address‹
Enter the town/city.	›City‹
Enter the country.	›State‹
Enter the postal code.	›Postal Code‹
Open destination guidance.	›Guidance‹
Start destination guidance.	›Start guidance‹
Terminate destination guidance.	›Stop guidance‹
Open the home address.	›Home address‹
Open the route criteria.	›Route preference‹
Open the route.	›Route information‹
Switch on the spoken instruction.	›Switch on voice instructions‹
Repeat the spoken instruction.	›Repeat voice instructions‹

Function	Command
Switch off the spoken instruction.	›Switch off voice instructions‹
Display the address book.	›Address book‹
Display the most recent destinations.	›Last destinations‹
Open the traffic bulletins.	›Traffic Info‹
Points of Interest.	›Points of interest‹

Map

Function	Command
Display the map.	›Map‹
Map facing north.	›Map facing north‹
Map facing the direction of travel.	›Map in direction of travel‹
Perspective map.	›Map perspective view‹
Automatic scaling of the map.	›Map with automatic scaling‹
Scale...feet.	›Map scale ... feet‹
Scale...meters.	›Map scale ... meters‹ e.g., map scale 100 meters
Scale...kilometers.	›Map scale ... kilometers‹ e.g., map scale 5 kilometers
Scale...miles.	›Map scale ... miles‹ e.g., map scale 5 miles

Destination guidance with intermediate destinations

Function	Command
Enter a new destination.	›Enter address‹

RADIO

FM

Function	Command
Open a frequency.	›Frequency ... megahertz‹ e.g., 93.5 megahertz or frequency 93.5
Open the radio.	›Radio‹
Open the FM stations.	›F M‹
Open the manual search.	›Manual‹
Select a frequency range.	›Select frequency‹
Open a station.	›Select station‹

AM

Function	Command
Open a frequency.	›Frequency ... Kilohertz‹ e.g., frequency 753 or 753 kilohertz
Open the AM stations.	›A M‹
Open the manual search.	›Manual‹

Satellite radio

Function	Command
Open the satellite radio.	›Satellite radio‹
Switch on the satellite radio.	›Satellite radio on‹
Select a satellite radio channel.	›Select satellite radio‹, e.g., satellite radio channel 2

Stored stations

Function	Command
Open the stored stations.	›Presets‹
Choose a stored station.	›Select preset‹
Select a stored station.	›Preset ...‹ e.g., stored station 2

CD/MULTIMEDIA

CD drive

Function	Command
Select a track.	›Track ...‹ e.g., track 5 or ›C D track ...‹ e. g., CD track 5
Play back a CD.	›C D on‹
Select a CD.	›Select C D‹
Select a CD and track.	›C D ... track ...‹ e.g., CD 3 track 5
Open the CD and Multimedia menu.	›C D and multimedia‹
CD.	›C D‹

External devices

Function	Command
Open the external devices.	›External devices‹
Open the Bluetooth devices.	›Bluetooth‹

Tone

Function	Command
Open the tone settings.	›Tone‹

TELEPHONE

Function	Command
Dial a phone number.	›Dial number‹
Open the Telephone menu.	›Telephone‹
Display the phone book.	›Phonebook‹
Redialing.	›Redial‹
Display received calls.	›Received calls‹

Function	Command
List of messages.	›Messages‹
Open the Bluetooth devices.	›Bluetooth‹

OFFICE

Function	Command
Open the Office menu.	›Office‹
Display Office Today.	›Current office‹
Display the contacts.	›Contacts‹
Display the messages.	›Messages‹
Display the calendar.	›Calendar‹
Display the tasks.	›Tasks‹
Display the reminders.	›Reminders‹

CONTACTS

Function	Command
Select a name.	›Choose name‹
My contacts.	›My contacts‹
Open the contacts.	›Contacts‹
New contact.	›New contact‹

EVERYTHING FROM A TO Z

INDEX

A

- ABS, Antilock Brake System **93**
- Acoustic signal, refer to Check Control **75**
- Activated charcoal filter with automatic climate control **104**
- Adaptive Light Control **80**
- Additional telephone **188**
- Additives, engine oil **233**
- Airbags **82**
- Airbags, indicator/warning light **85**
- Air circulation, refer to Recirculated air mode, air conditioner **101**
- Air circulation, refer to Recirculated air mode, automatic climate control **103**
- Air conditioning **100**
- Air conditioning mode, air conditioner **100**
- Air conditioning mode, automatic climate control **102**
- Air distribution, air conditioner, manual **101**
- Air distribution, automatic **103**
- Air distribution, automatic climate control, manual **103**
- Air distribution, individual **101**
- Air drying, refer to Cooling function **104**
- Air flow rate for air conditioner **100**
- Air flow rate with automatic climate control **103**
- Air pressure, refer to Tire inflation pressure **218**
- Air supply, air conditioner **100**
- Air supply, automatic climate control **102**
- Alarm system **39**
- Alarm system, avoiding unintentional alarms **40**
- Alarm system, ending an alarm **39**
- Alarm system, interior motion sensor **40**
- Alarm system, tilt alarm sensor **40**
- ALL4 all-wheel system **95**
- All-wheel drive, refer to ALL4 **95**
- Alternating-code hand-held transmitter **106**
- AM/FM station **156**
- Ambient lighting **81**
- Announcement, navigation, see Spoken instructions **145**
- Antifreeze, washer fluid **64**
- Antilock Brake System, ABS **93**
- Anti-slip control, refer to Dynamic Stability Control **DSC 93**
- Anti-theft protection **31**
- Appointments **204**
- Approved engine oils **233**
- Ashtray **109**
- Assistance, roadside **248**
- Assistance when driving off, refer to Hill drive-off assistant **95**
- Assistance with starting engine, refer to Jump-starting **248**
- Audio playback **165**
- Audio playback, Bluetooth **171**
- Automatic air distribution **103**
- Automatic air flow **103**
- Automatic car wash **254**
- Automatic climate control **102**
- Automatic climate control, automatic air distribution **103**
- Automatic, cruise control **97**
- Automatic headlight control **78**
- Automatic transmission with Steptronic **65**
- AUTO program with automatic climate control **103**
- AUX-IN port **167**
- Average fuel consumption **70**
- Average speed **70**
- Average speed, refer to Computer **69**

B

- Backrest curvature, refer to Lumbar support **45**
- Backrests, refer to Seats **44**
- Backup lights, bulb replacement **243**
- Balance **154**
- Bass **154**
- Battery disposal **39**
- Battery, refer to Vehicle battery **246**
- Battery, remote control **30**
- Battery replacement, remote control **39**
- Belts, refer to Safety belts **46**
- Belt tensioners, refer to Safety belts **46**
- Bi-xenon headlights **239**
- Black and white map display **148**

Bluetooth audio [171](#)
 Bluetooth connection, activating/deactivating, hands-free system [179](#)
 Bluetooth connection, activating/deactivating, mobile phone preparation [189](#)
 Bluetooth hands-free system [178](#)
 Brake assistant [93](#)
 Brake discs, breaking in [120](#)
 Brake fluid, refer to Service requirements [74](#)
 Brake force distribution, electronic [93](#)
 Brake pads, breaking in [120](#)
 Brake, refer to Parking brake [60](#)
 Brakes, MINI maintenance system [236](#)
 Brakes, service requirements [74](#)
 Brake system, MINI maintenance system [236](#)
 Braking, notes [121](#)
 Braking, parking brake [60](#)
 Breakdown assistance, Roadside Assistance [248](#)
 Breaking in [120](#)
 Brightness on the Control Display [74](#)
 Buckle tongues height adjustment [47](#)
 Button for starting the engine, refer to Start/Stop button [58](#)

C

Calendar [204](#)
 California Proposition 65 Warning [7](#)
 Car battery, refer to Vehicle battery [246](#)
 Car care products [255](#)
 Care, displays [257](#)
 Care, vehicle [255](#)

Cargo area, Comfort Access [37](#)
 Cargo area door, refer to Tailgate [35](#)
 Cargo area, enlarging, cargo cover [111](#)
 Cargo area, flat loading floor [113](#)
 Cargo area light, refer to Interior lights [81](#)
 Cargo area, multi-function hook [114](#)
 Cargo area, opening from the outside [35](#)
 Cargo area, partition net [113](#)
 Car horn, refer to Horn [12](#)
 Carpet, care [257](#)
 Car phone, refer to Telephone [178](#)
 Car phone, refer to Telephone, mobile phone preparation [188](#)
 Car wash [254](#)
 CBC, Cornering Brake Control [93](#)
 CBS Condition Based Service [236](#)
 CD [164](#)
 CD/DVD drives, care [257](#)
 CD player [164](#)
 Center armrest [116](#)
 Center console, refer to Around the center console [16](#)
 Center rail [116](#)
 Center rail, refer to Storage compartments [116](#)
 Central locking, Comfort Access [37](#)
 Central locking from the inside [34](#)
 Central locking system, concept [31](#)
 Central locking system, from the outside [31](#)

Central screen, see Control Display [18](#)
 Changes, technical, refer to Own Safety [6](#)
 Changing wheels/tires [224](#)
 Check Control [75](#)
 Children, transporting [53](#)
 Child restraint fixing system LATCH [55](#)
 Child restraint fixing systems [53](#)
 Child restraint fixing systems, mounting [54](#)
 Child seat, mounting [54](#)
 Child seats, refer to Transporting children safely [53](#)
 Chrome parts, care [256](#)
 Circulation of air, refer to Recirculated air mode, air conditioner [101](#)
 Circulation of air, refer to Recirculated air mode, automatic climate control [103](#)
 Cleaning, displays [257](#)
 Cleaning, refer to Care [254](#)
 Climate [100](#)
 Climate mode, ventilation [104](#)
 Clock [68](#)
 Clock, 12h/24h format [72](#)
 Clock, setting the time and date [72](#)
 Clock, setting the time zone [73](#)
 Closing from the inside [34](#)
 Closing from the outside [32](#)
 Clutch, breaking in [120](#)
 Cockpit [12](#)
 Cold start, refer to Starting the engine [59](#)
 Combination instrument, refer to Displays [14](#)
 Combination switch, refer to Turn signal/high-beams/headlight flasher [61](#)

- Combination switch, refer to Washer/wiper system [61](#)
- Comfort Access [37](#)
- Comfort Access, in the car wash [38](#)
- Comfort Access, replacing the battery [39](#)
- Comfort area, refer to Around the center console [16](#)
- Compartment for remote control, refer to Ignition lock [58](#)
- Compass, digital [107](#)
- Computer [69](#)
- Computer, displaying information [69](#)
- Condition Based Service CBS [236](#)
- Confirmation signals for vehicle locking/unlocking [33](#)
- Connecting, mobile phone, refer to Mobile phone, pairing, hands-free system [179](#)
- Connecting, mobile phone, refer to Pairing the mobile phone [189](#)
- Consumption, refer to Average fuel consumption [70](#)
- Contacts for hands-free system [185](#)
- Contacts, Office [201](#)
- Control Display [18](#)
- Control Display, care [257](#)
- Control Display, settings [73](#)
- Controls and displays [12](#)
- Control systems, driving stability [93](#)
- Convenient operation, window [32](#)
- Coolant temperature [69](#)
- Cooling function, switching on and off [104](#)
- Cooling, maximum [103](#)
- Cornering Brake Control, CBC [93](#)
- Corrosion on brake discs [122](#)
- Cradle for telephone or mobile phone, refer to Snap-in adapter [198](#)
- Cruise control [97](#)
- Cupholders [109](#)
- Current fuel consumption [70](#)
- Current location, storing [136](#)
- Curve lights, refer to Adaptive Light Control [80](#)
- ## D
- Dashboard lighting, refer to Instrument lighting [80](#)
- Dashboard, refer to Cockpit [12](#)
- Dashboard, refer to Displays [14](#)
- Date, date format [73](#)
- Date, setting [73](#)
- Daytime running lights [79](#)
- Decorative trim, care [257](#)
- Defogging windows [101](#)
- Defroster, rear window, automatic climate control [104](#)
- Defroster, rear window, with air conditioner [101](#)
- Defrosting windows [101](#)
- Defrost setting, refer to Defrosting windows [101](#)
- Destination entry via the address book [136](#)
- Destination guidance with intermediate destinations [141](#)
- Destination input, navigation [134](#)
- Digital compass [107](#)
- Digital radio [158](#)
- Dip stick, engine oil [232](#)
- Directional indicators, refer to Turn signals [61](#)
- Display lighting, refer to Instrument lighting [80](#)
- Displays [14](#)
- Displays and controls [12](#)
- Displays, care [257](#)
- Displays, cleaning [257](#)
- Displays, refer to Instrument cluster [14](#)
- Disposal, remote control battery [39](#)
- Distance warning, refer to Park Distance Control PDC [99](#)
- Door key, refer to Remote control with integrated key [30](#)
- Door lock [34](#)
- Door lock, confirmation signals [33](#)
- Doors, manual operation [34](#)
- Doors, unlocking and locking, confirmation signals [33](#)
- Doors, unlocking and locking from the inside [34](#)
- Doors, unlocking and locking, from the outside [32](#)
- DOT Quality Grades [222](#)
- Drive-off assistant, refer to Hill drive-off assistant [95](#)
- Driving notes, breaking in [120](#)
- Driving off on hills, refer to Hill drive-off assistant [95](#)
- Driving on poor roads [122](#)
- Driving stability control systems [93](#)
- Driving tips, refer to Driving notes [120](#)
- Dry air, refer to Cooling function [104](#)
- DSC Dynamic Stability Control [93](#)
- DTC Dynamic Traction Control [94](#)
- DTMF suffix dialing, hands-free system [181](#)
- DTMF suffix dialing, mobile phone preparation [193](#)
- Dynamic destination guidance [150](#)

Dynamic Stability Control DSC **93**

Dynamic Traction Control DTC **94**

E

Electrical malfunction, door lock **34**

Electrical malfunction, fuel filler flap **214**

Electronic brake-force distribution **93**

Electronic Stability Program ESP, refer to Dynamic Stability Control DSC **93**

Emergency operation, fuel filler flap, unlocking manually **214**

Emergency operation, refer to Manual operation **34**

Emergency operation, Step-tronic transmission, refer to Selector lever lock, overriding **67**

Energy, saving, refer to Saving fuel **128**

Engine, breaking in **120**

Engine compartment **230**

Engine oil, adding **232**

Engine oil, additives, refer to Approved engine oils **233**

Engine oil, alternative oil types **233**

Engine oil change intervals, refer to Service requirements **74**

Engine oil, dip stick **232**

Engine oil, filling capacity **263**

Engine oil, MINI maintenance system **236**

Engine oil types, alternative **233**

Engine oil types, approved **233**

Engine, overheating, refer to Coolant temperature **69**

Engine start, assistance **248**

Engine, starting **59**

Engine, starting, Comfort Access **37**

Engine, starting, Start/Stop button **58**

Engine, stopping, Start/Stop button **58**

Engine, switching off **60**

Equipment, interior **105**

ESP Electronic Stability Program, refer to Dynamic Stability Control DSC **93**

Exchanging wheels/tires **224**

Exterior mirrors **50**

Exterior mirrors, adjusting **50**

Exterior mirrors, folding in and out **51**

Exterior sensors, care **257**

External devices **167**

External temperature display **68**

External temperature display, changing the unit of measure **72**

External temperature display, on onboard computer **72**

External temperature warning **68**

F

Fader **154**

Failure messages, refer to Check Control **75**

False alarm, refer to Avoiding unintentional alarms **40**

Fan, refer to Air flow rate for air conditioner **100**

Fan, refer to Air flow rate with automatic climate control **103**

Fastening safety belts, refer to Safety belts **46**

Fault messages, refer to Check Control **75**

Filling capacities **263**

Filter, refer to Activated-charcoal filter **102**

Filter, refer to Microfilter **102**

Filter, refer to Microfilter/activated-charcoal filter with automatic climate control **104**

First aid kit **248**

First aid, refer to First aid kit **248**

Flashing when locking/unlocking **33**

Flat tire, Flat Tire Monitor **86**

Flat tire, indicator/warning lamp **86**

Flat Tire Monitor FTM **85**

Flat Tire Monitor FTM, flat tire message **86**

Flat Tire Monitor FTM, initializing the system **86**

Flat Tire Monitor FTM, snow chains **85**

Flat Tire Monitor FTM, system limits **85**

Flat tire, run-flat tire **87**

Flat tire, Tire Pressure Monitor **87**

Flat tire, Tire Pressure Monitor TPM **87**

Flat tire, wheel change **245**

Floor mats, care **257**

FM/AM station **156**

Fog lights **80**

Foot brake **121**

Footwell lights, refer to Interior lights **81**

Four-wheel drive, refer to ALL4 **95**

Front airbags **82**

Front fog light, bulb replacement **241**

Front fog lights **80**

Front lights, bulb replacement **240**

- Front passenger airbags, deactivating **83**
- FTM Flat Tire Monitor **85**
- Fuel **216**
- Fuel, additives **216**
- Fuel, average consumption **70**
- Fuel cap, closing **214**
- Fuel consumption display, average fuel consumption **70**
- Fuel filler flap, closing **214**
- Fuel filler flap, opening **214**
- Fuel filler flap, unlocking in case of an electrical malfunction **214**
- Fuel gauge **69**
- Fuel, refer to Average fuel consumption **70**
- Fuel, saving **128**
- Fuel tank capacity, refer to Filling capacities **263**
- Fuel tank contents, refer to Filling capacities **263**
- Fuel tank, refer to Filling capacities **263**
- Fuse **247**
- G**
- Garage door opener, refer to Integrated universal remote control **105**
- Gasoline **216**
- Gasoline gauge, refer to Fuel gauge **69**
- Gas station recommendation **145**
- Gear change, manual transmission **65**
- Gear change, Steptronic transmission **65**
- Gear display, Steptronic transmission **65**
- Glare protection **107**
- Glass sunroof, electrical **40**
- Glass sunroof, electrical, opening/closing **41**
- Glass sunroof, electrical, raising **41**
- Glass sunroof, electric, convenient operation **32**
- Glass sunroof, electric, remote control **32**
- GPS navigation, refer to Navigation system **132**
- H**
- Halogen headlights, bulb replacement **240**
- Handbrake, refer to Parking brake **60**
- Hand car wash, care **255**
- Hand-held transmitter, alternating code **106**
- Hands-free system **16, 178**
- Hazard warning system **16**
- HD Radio **158**
- Head airbags **82**
- Headlamp control, refer to Parking lamps/low beams **78**
- Headlamps, care **255**
- Headlight control, automatic **78**
- Headlight courtesy delay feature **79**
- Headlight flasher **61**
- Headlight flasher, indicator lamp **15**
- Headlights **78**
- Headlights, cleaning, washer fluid **64**
- Head restraints **49**
- Head restraints, adjusting the height **49**
- Head restraints, removing **50**
- Heatable rear window, air conditioner **101**
- Heatable windshield **104**
- Heating, rear window with automatic climate control **104**
- Heating, seats **46**
- Heating, windshield **104**
- Height adjustment, seats **44**
- High-beams **79**
- High beams, bulb replacement **240**
- High-beams, indicator lamp **15**
- Hill drive-off assistant **95**
- Hills **122**
- Holder for remote control, refer to Ignition lock **58**
- Homepage **6**
- Hood **231**
- Hood, closing **231**
- Hood, opening **231**
- Hood, unlocking **231**
- Horn **12**
- House number, entering for navigation **135**
- Hydraulic brake assistant **93**
- I**
- Ice warning, refer to External temperature warning **68**
- Icy roads, refer to External temperature warning **68**
- Identification marks, run-flat tires **226**
- Identification marks, tires **222**
- iDrive, changing settings **73**
- iDrive, changing the date and time **72**
- iDrive, changing the language **73**
- iDrive, changing the units of measure and display format **72**
- iDrive, setting the brightness **74**
- Ignition **58**
- Ignition key position 1, refer to Radio ready state **58**

Ignition key position 2, refer to Ignition on [58](#)
 Ignition key, refer to Remote control with integrated key [30](#)
 Ignition lock [58](#)
 Ignition, switched off [59](#)
 Ignition, switched on [58](#)
 Indicator and warning lamps, Tire Pressure Monitor TPM [89](#)
 Indicator and warning lights [15](#)
 Individual air distribution [101](#)
 Inflation pressure monitor, refer to Flat Tire Monitor [85](#)
 Inflation pressure monitor, refer to Tire Pressure Monitor TPM [87](#)
 Inflation pressure, refer to Tire inflation pressure [218](#)
 Information on the navigation data [132](#)
 Initializing, compass, refer to Calibrating [108](#)
 Initializing, Flat Tire Monitor FTM [86](#)
 Initializing, glass sunroof, electrical [41](#)
 Initializing, refer to Setting the time and date [72](#)
 Instrument cluster, refer to Displays [14](#)
 Instrument lighting [80](#)
 Instruments, refer to Cockpit [12](#)
 Integrated key [30](#)
 Integrated universal remote control [105](#)
 Interactive map [139](#)
 Interior equipment [105](#)
 Interior lights [81](#)
 Interior lights, remote control [33](#)
 Interior mirror [51](#)
 Interior motion sensor [40](#)

Interior rearview mirror, compass [107](#)
 Interior temperature, setting, air conditioner [100](#)
 Interior temperature, setting, automatic climate control [102](#)
 Internet page [6](#)
 Intersection, entering for navigation [135](#)

J

Jump-starting [248](#)

K

Keyless Go, refer to Comfort Access [37](#)
 Keyless opening and closing, refer to Comfort Access [37](#)
 Key Memory, refer to Personal Profile [31](#)
 Key, refer to Remote control with integrated key [30](#)
 Kickdown, Steptronic transmission [66](#)
 Knee airbag [82](#)
 Knocking control [216](#)

L

Lamp and bulb replacement, bulb replacement [239](#)
 Lamp, replacing, refer to Lamp and bulb replacement [239](#)
 Lamps [78](#)
 Lamps, automatic headlight control [78](#)
 Language, changing on the Control Display [73](#)
 Lap-and-shoulder belt, refer to Safety belts [46](#)
 LATCH child restraint fixing system [55](#)

Leather care [256](#)
 LEDs, light-emitting diodes [239](#)
 Letters and numbers, entering [22](#)
 License plate light, bulb replacement [243](#)
 Light-alloy wheels, care [256](#)
 Light-emitting diodes, LEDs [239](#)
 Lighter, socket [109](#)
 Lighting, instruments [80](#)
 Lighting, light and bulb replacement [239](#)
 Lighting, vehicle, refer to Lamps [78](#)
 Lights, parking lamps/low beams [78](#)
 Light switch [78](#)
 Limit, refer to Speed limit [91](#)
 Lock buttons on doors, refer to Locking [35](#)
 Locking from the inside [35](#)
 Locking, from the outside [33](#)
 Locking, setting the confirmation signal [33](#)
 Locking the vehicle from the inside [34](#)
 Locking the vehicle from the outside [32](#)
 Locking without remote control, refer to Comfort Access [37](#)
 Longlife oils, alternative oil types [233](#)
 Longlife oils, refer to Approved engine oils [233](#)
 Low beams [78](#)
 Low beams, automatic [78](#)
 Low beams, bulb replacement [240](#)
 Lower back support, refer to Lumbar support [45](#)
 Lumbar support [45](#)

M

Main inspection, refer to Service requirements [74](#)

Maintenance, refer to Service booklet

Maintenance, refer to Service requirements [74](#)

Maintenance requirements [236](#)

Maintenance system
MINI [236](#)

Makeup mirror [107](#)

Malfunction, door lock [34](#)

Malfunction, fuel filler flap [214](#)

Malfunction, Steptronic transmission [67](#)

Malfunction warnings, refer to Check Control [75](#)

Manual air distribution, air conditioner [101](#)

Manual air distribution, automatic climate control [103](#)

Manual mode, Steptronic transmission [66](#)

Manual operation, door lock [34](#)

Manual operation, fuel filler flap [214](#)

Manual operation, selector lever lock, Steptronic transmission [67](#)

Map, destination entry [139](#)

Map display in black and white [148](#)

Map view [146](#)

Marking on approved tires [225](#)

Maximum cooling [103](#)

Maximum speed, winter tires [225](#)

Menu operation, onboard monitor [18](#)

Menus, refer to Onboard monitor operating concept [19](#)

Message list, traffic bulletins [147](#)

Messages [203](#)

Microfilter [102](#)

Microfilter, with automatic climate control [104](#)

MINI Connected [208](#)

MINI Homepage [6](#)

MINI Internet page [6](#)

MINI maintenance system [236](#)

MINI Mobility System [226](#)

Minimum tread, tires [224](#)

Mirrors [50](#)

Mirrors, folding in and out [51](#)

Mirrors, interior mirror [51](#)

Mobile communication devices in the vehicle [121](#)

Mobile phone, refer to Telephone, mobile phone preparation [188](#)

Mobile phone, refer to Telephone with hands-free system [178](#)

Mobile phone with hands-free system [178](#)

Mobile phone with mobile phone preparation [188](#)

Mobility System [226](#)

Modifications, technical, refer to Own Safety [6](#)

Monitor, see Control Display [18](#)

Mounting of child restraint fixing systems [54](#)

MP3 player [167](#)

N

Navigation [132](#)

Navigation data [132](#)

Navigation data, updating [132](#)

Navigation system, destination entry by voice [140](#)

Neck restraints, refer to Head restraints [49](#)

New wheels and tires [224](#)

Notes [6](#), [205](#)

Nozzles, refer to Ventilation [104](#)

O

OBD Onboard Diagnostics [237](#)

OBD socket, refer to Socket for OBD Onboard Diagnosis [237](#)

Octane number, refer to Fuel quality [216](#)

Octane rating, refer to Recommended fuel grade [216](#)

Odometer [68](#)

Office [200](#)

Oil additives [233](#)

Oil level [232](#)

Oil types, alternative [233](#)

Oil types, approved [233](#)

Onboard Diagnostics
OBD [237](#)

Onboard monitor [18](#)

Opening and closing, Comfort Access [37](#)

Opening and closing from the inside [34](#)

Opening and closing from the outside [32](#)

Opening and closing, using the door lock [34](#)

Opening and closing, via the remote control [32](#)

Opening and unlocking from the inside [35](#)

Operating concept of the onboard monitor [18](#)

Outside air mode, automatic climate control [103](#)

Outside air, refer to Recirculated air mode, air conditioner [101](#)

Outside air, refer to Recirculated air mode, automatic climate control [103](#)

Overheating of engine, refer to Coolant temperature [69](#)

Own safety [6](#)

P

Pairing, mobile phone [189](#)

Pairing, mobile phone, hands-free system [179](#)

Park Distance Control PDC [99](#)

Parking aid, refer to Park Distance Control PDC [99](#)

Parking assistant, refer to Park Distance Control PDC [99](#)

Parking brake [60](#)

Parking light, bulb replacement [241](#)

Parking lights [78](#)

Parking lights/low beams [78](#)

PDC Park Distance Control [99](#)

Personal information [200](#)

Personal Profile [31](#)

Pinch protection, windows [43](#)

Pivoting sun visor [107](#)

Plastic, care [256](#)

Pollen, refer to Microfilter [102](#)

Pollen, refer to Microfilter/activated-charcoal filter [102](#)

Pollen, refer to Microfilter/activated-charcoal filter with automatic climate control [104](#)

Poor road operation [122](#)

Position, storing [136](#)

Postal code, entering in navigation [135](#)

Power windows [42](#)

Power windows, refer to Windows [42](#)

Prescribed engine oils, refer to Approved engine oils [233](#)

Pressure monitoring of tires, refer to Tire Pressure Monitor TPM [87](#)

Pressure, tires [218](#)

Pressure warning, tires [85](#)

Profile depth, refer to Minimum tread depth [224](#)

Profile, tires [223](#)

Protective function, refer to Pinch protection system, windows [43](#)

R

Radio [156](#)

Radio-operated key, refer to Remote control with integrated key [30](#)

Radio ready state [58](#)

Radio ready state, switched off [59](#)

Radio ready state, switched on [58](#)

Radio setting, refer to Radio ready state [58](#)

Rain sensor [62](#)

Random [165](#)

Random playback [165](#)

Range [70](#)

RDS [157](#)

Reading out loud [206](#)

Rear [45](#)

Rear fog light, bulb replacement [243](#)

Rear fog lights, indicator lamp [15](#)

Rear lights, refer to Tail lights [243](#)

Rear seat backrests, foldable, MINI Countryman [111](#)

Rear seat backrests, foldable, MINI Paceman [112](#)

Rearview mirror, refer to Mirrors [50](#)

Rear window defroster with air conditioner [101](#)

Rear window defroster with automatic climate control [104](#)

Rear window, washing [63](#)

Rear window wiper [63](#)

Recirculated air mode, air conditioner [101](#)

Recirculated air mode, automatic climate control [103](#)

Recommended fuel grade [216](#)

Recommended tire brands [225](#)

Redialing, hands-free system [181](#)

Redialing, mobile phone preparation [193](#)

Releasing, refer to Unlocking [37](#)

Remaining range for service, refer to Service requirements [74](#)

Remaining range, refer to Range [70](#)

Reminders [206](#)

Remote control [30](#)

Remote control, battery replacement [39](#)

Remote control, Comfort Access [37](#)

Remote control, Comfort Access, malfunctions [38](#)

Remote control, garage door opener [105](#)

Remote control, radio interference [33](#)

Remote control, removing from the ignition lock [58](#)

Remote control, service data [236](#)

Remote control, universal [105](#)

Remote inquiry, hands-free system [181](#)

- Remote inquiry, mobile phone preparation [193](#)
 - Replacement remote control [30](#)
 - Replacing wheels/tires [224](#)
 - Reporting safety malfunctions [9](#)
 - Reserve warning, refer to Fuel gauge [69](#)
 - Reservoir for washer fluid, refer to Washer fluid reservoir [64](#)
 - Restraining systems, refer to Safety belts [46](#)
 - Restraint systems for children [53](#)
 - Retreaded tires [225](#)
 - Reverse gear, manual transmission [65](#)
 - Road, avoiding [143](#)
 - Road detour [143](#)
 - Roadside Assistance [248](#)
 - Roadside parking light, bulb replacement [241](#)
 - Roadside parking lights [79](#)
 - RON recommended fuel grade [216](#)
 - RON, refer to Fuel quality [216](#)
 - Route [144](#)
 - Route criteria, route [143](#)
 - Route, displaying [144](#)
 - Route section, bypassing [144](#)
 - Rubber seals, care [256](#)
 - Run-flat tires [226](#)
 - Run-flat tires, flat tire [86](#)
 - Run-flat tires, tire inflation pressure [218](#)
- S**
- Safe braking [121](#)
 - Safety belts, care [257](#)
 - Safety belts, damage [49](#)
 - Safety belts, indicator/warning light [49](#)
 - Safety belts, rear center safety belt [48](#)
 - Safety belts, reminder [49](#)
 - Safety systems, airbags [82](#)
 - Safety systems, safety belts [46](#)
 - Satellite radio [158](#)
 - Saving fuel [128](#)
 - Scale, changing during navigation [147](#)
 - Screen, see Control Display [18](#)
 - Seat adjustment [45](#)
 - Seat adjustment, manual [44](#)
 - Seat belts [46](#)
 - Seat heating [46](#)
 - Seats [44](#)
 - Seats, adjusting [44](#)
 - Seats, heating [46](#)
 - Seats, sitting safely [44](#)
 - Selector lever lock, overriding [67](#)
 - Selector lever lock, refer to Selector level positions, changing, shiftlock [65](#)
 - Selector lever positions, Step-tronic transmission [65](#)
 - Selector lever, Step-tronic transmission [65](#)
 - Service and warranty [7](#)
 - Service data in the remote control [236](#)
 - Service interval display, refer to Condition Based Service CBS [236](#)
 - Service interval display, refer to Service requirements [74](#)
 - Service requirements [74](#)
 - Service requirements, CBS Condition Based Service [236](#)
 - Settings and information [71](#)
 - Settings, changing on the Control Display [73](#)
 - Settings, clock, 12h/24h mode [72](#)
 - Settings, configuring, refer to Personal Profile [31](#)
 - Settings, language [73](#)
 - Shifting, manual transmission [65](#)
 - Shifting, Step-tronic transmission [66](#)
 - Shift lever, Step-tronic transmission [65](#)
 - Shift paddles on the steering wheel [66](#)
 - Short commands, voice activation [264](#)
 - Side airbags [82](#)
 - Side windows, refer to Windows [42](#)
 - Sitting safely [44](#)
 - Sliding/tilting sunroof, refer to Glass sunroof, electrical [40](#)
 - Slot for remote control [58](#)
 - Snap-in adapter, mobile phone [198](#)
 - Snow chains [229](#)
 - Socket, OBD Onboard Diagnostics [237](#)
 - Software applications, iPhone [208](#)
 - Software part number, hands-free system [178](#)
 - Software part number, mobile phone preparation [188](#)
 - Software update [175](#)
 - Special destinations, navigation [138](#)
 - Special equipment, series equipment [6](#)
 - Speed, average [70](#)
 - Speed limit [91](#)
 - Speed limit, setting [92](#)
 - Speedometer [14](#)
 - Speed, with winter tires [225](#)
 - Spoken instructions, navigation [145](#)
 - Sport button [95](#)
 - Sport program, Step-tronic transmission [66](#)
 - Stability control systems [93](#)
 - Start/Stop button [58](#)

Start/Stop button, starting the engine **59**
 Start/Stop button, switching off the engine **60**
 Starting the engine **59**
 Start problems, refer to Jump-starting **248**
 State/province, selecting for navigation **134**
 Stations, stored **163**
 Station, storing **157**
 Status information, onboard monitor **21**
 Steering wheel **52**
 Steering wheel, adjusting **52**
 Steering wheel lock **58**
 Steering wheel, shift paddles **66**
 Steptronic transmission **65**
 Steptronic transmission, kick-down **66**
 Steptronic transmission, overriding the selector lever lock **67**
 Stopping, engine **60**
 Storage, tires **226**
 Storing the vehicle **257**
 Street, entering for navigation **135**
 Summer tires, refer to Wheels and tires **218**
 Summer tires, tread **223**
 Sun visor **107**
 Switches, refer to Cockpit **12**
 Switching off, engine **60**
 Switching off, vehicle **60**
 Symbols **6**

T

Tachometer **69**
 Tailgate **35**
 Tailgate, Comfort Access **37**
 Tailgate, opening/closing **35**
 Tailgate, opening from the outside **35**

Tail lights **243**
 Tank gauge, refer to Fuel gauge **69**
 Tasks **205**
 Technical changes, refer to Own Safety **6**
 Telephone, adjusting the volume hands-free system **181**
 Telephone, adjusting the volume mobile phone preparation **193**
 Telephone, hands-free system **178**
 Telephone, mobile phone preparation **188**
 Temperature, air conditioner **101**
 Temperature, automatic climate control **103**
 Temperature, changing the unit of measure **72**
 Temperature, coolant, refer to Coolant temperature **69**
 Temperature display, external temperature **68**
 Temperature display, external temperature warning **68**
 Temperature display, setting the units **72**
 Temperature warning **68**
 Text messages **203**
 Theft alarm system, refer to Alarm system **39**
 Tilt alarm sensor **40**
 Time, setting the time **72**
 Tire age **224**
 Tire, flat tire **86**
 Tire identification marks **222**
 Tire inflation pressure **218**
 Tire inflation pressure, pressure loss, FTM **86**
 Tire pressure loss, RDC **89**
 Tire, pressure monitoring, refer to Tire Pressure Monitor TPM **87**

Tire pressure monitor, refer to Flat Tire Monitor **85**
 Tire Pressure Monitor TPM **87**
 Tire Pressure Monitor TPM, system limits **90**
 Tire Pressure Monitor TPM, system reset **88**
 Tire Pressure Monitor TPM, warning lamp **89**
 Tire Quality Grading **222**
 Tires, breaking in **120**
 Tires, changing **224**
 Tires, condition **223**
 Tires, damage **224**
 Tire size **222**
 Tires, minimum tread **224**
 Tires, retreaded tires **225**
 Tires, storage **226**
 Tire tread **223**
 Toll roads, route **143**
 Tone **154**
 Towing another vehicle **250**
 Towing, being towed **250**
 Town/city, navigation **134**
 Tow-starting **250**
 TPM, refer to Tire Pressure Monitor **87**
 Traction control **94**
 Traffic bulletins, navigation **147**
 Transmission lock, refer to Changing the selector lever positions **65**
 Transmission, overriding the selector lever lock with Steptronic transmission **67**
 Transmission, refer to Manual transmission **65**
 Transmission, see Steptronic transmission **65**
 Transporting children safely **53**
 Treble, tone **154**
 Trip-distance counter, refer to Trip odometer **68**

Triple turn signal activation [61](#)
 Trip odometer [68](#)
 Trips, planning [141](#)
 Trunk lid, refer to Tailgate [35](#)
 Trunk, refer to Cargo area [35](#)
 Turning lights, refer to Adaptive Light Control [80](#)
 Turn signal, bulb replacement [241](#)
 Turn signal indicator lamp [14](#)
 Turn signals [61](#)
 Turn signals, triple turn signal activation [61](#)

U

Uniform Tire Quality Grading/UTQG [222](#)
 Unintentional alarms, avoiding [40](#)
 Units, average fuel consumption [72](#)
 Units of measure, changing on the Control Display [72](#)
 Units, temperature [72](#)
 Universal remote control [105](#)
 Unlocking from the inside [35](#)
 Unlocking, from the outside [32](#)
 Unlocking, tailgate [37](#)
 Unlocking, without remote control, refer to Comfort Access [37](#)
 Update, software [175](#)
 Upholstery care [256](#)
 Upholstery material care [256](#)

V

Vanity mirror [107](#)
 Vehicle battery [246](#)
 Vehicle, breaking in [120](#)
 Vehicle care [255](#)
 Vehicle care, refer to Care [254](#)

Vehicle equipment [6](#)
 Vehicle identification number, hands-free system [178](#)
 Vehicle identification number, mobile phone preparation [188](#)
 Vehicle paintwork, care [255](#)
 Vehicle storage [257](#)
 Vehicle, switching off [60](#)
 Vehicle wash [254](#)
 Ventilation, air conditioning [104](#)
 Version of the navigation data [132](#)
 Video playback, iPhone [170](#)
 Video playback, snap-in adapter [170](#)
 Voice activation, navigation [140](#)
 Voice activation, short commands [264](#)
 Voice activation system [24](#)
 Volume, setting [154](#)

W

Warning and indicator lamps [15](#)
 Warning messages, refer to Check Control [75](#)
 Warning signal volumes [154](#)
 Warning triangle [248](#)
 Washer/wiper system [61](#)
 Washer/wiper system, rain sensor [62](#)
 Washer/wiper system, washer fluid [64](#)
 Washer fluid [64](#)
 Washer fluid reservoir [64](#)
 Washing, vehicle [254](#)
 Welcome lights [79](#)
 Wheel change [245](#)
 Wheels and tires [218](#)
 Wheels, changing [224](#)
 Wheels, Flat Tire Monitor FTM [85](#)
 Window, convenient operation [32](#)
 Windows [42](#)
 Windows, care [255](#)
 Windows, closing [42](#)
 Windows, defrosting and defogging [101](#)
 Windows, opening [42](#)
 Windows, pinch protection [43](#)
 Windshield defroster [104](#)
 Windshield, defrosting and defogging [101](#)
 Windshield, defrosting, refer to Defrosting windows [101](#)
 Windshield wash [61](#)
 Windshield washer fluid [64](#)
 Windshield wash, rear window [63](#)
 Windshield wash, reservoir for washer fluid [64](#)
 Windshield wash, washer fluid [64](#)
 Windshield wiper blades, changing [238](#)
 Windshield wiper, refer to Washer/wiper system [61](#)
 Winter storage, care [257](#)
 Winter tires [225](#)
 Winter tires, setting the speed limit [92](#)
 Winter tires, tread [223](#)
 Wiper blades, care [255](#)
 Wiper blades, changing [238](#)
 Wiper fluid [64](#)
 Word match concept, navigation [23](#)

Y

Your individual vehicle, settings, refer to Personal Profile [31](#)



01 40 2 964 459 ue

DRIVE ME.

Online Edition for Part no. 01 40 2 964 459 - VI/15